

WD-22

km 38+491,21

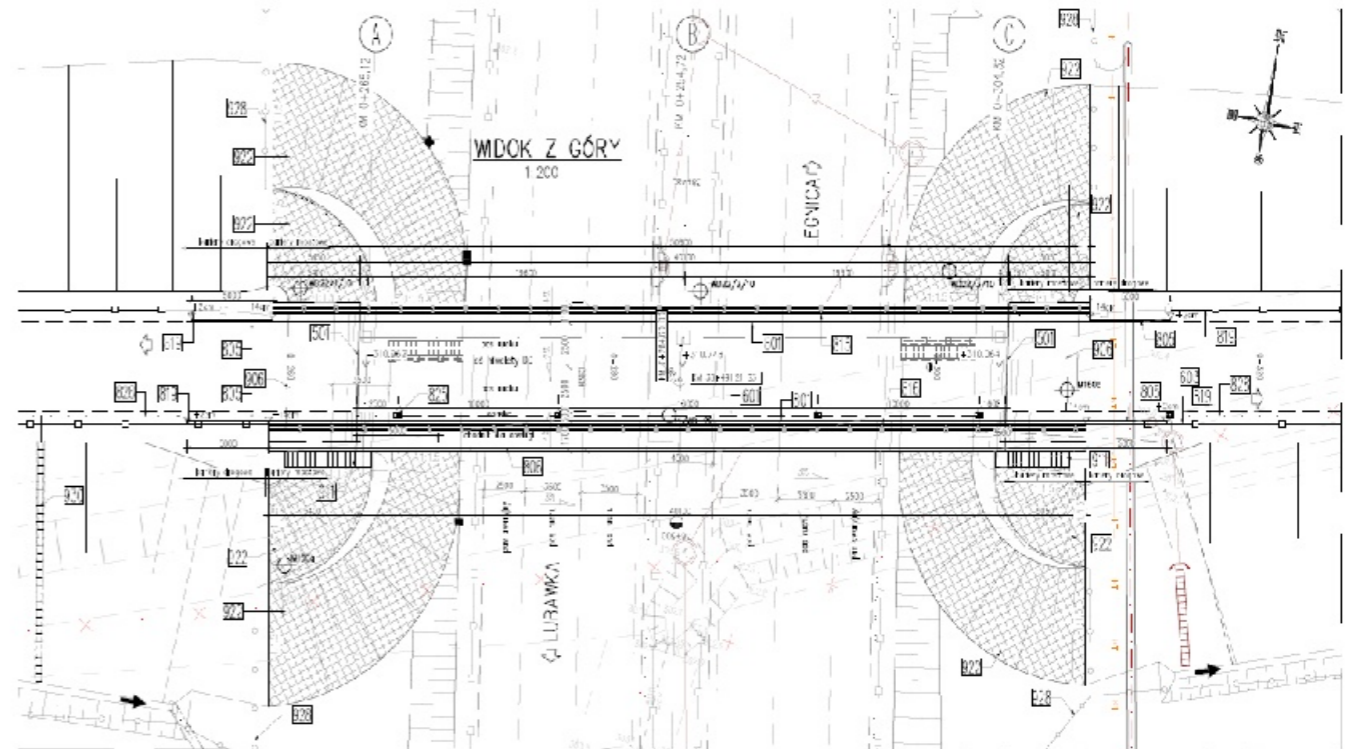
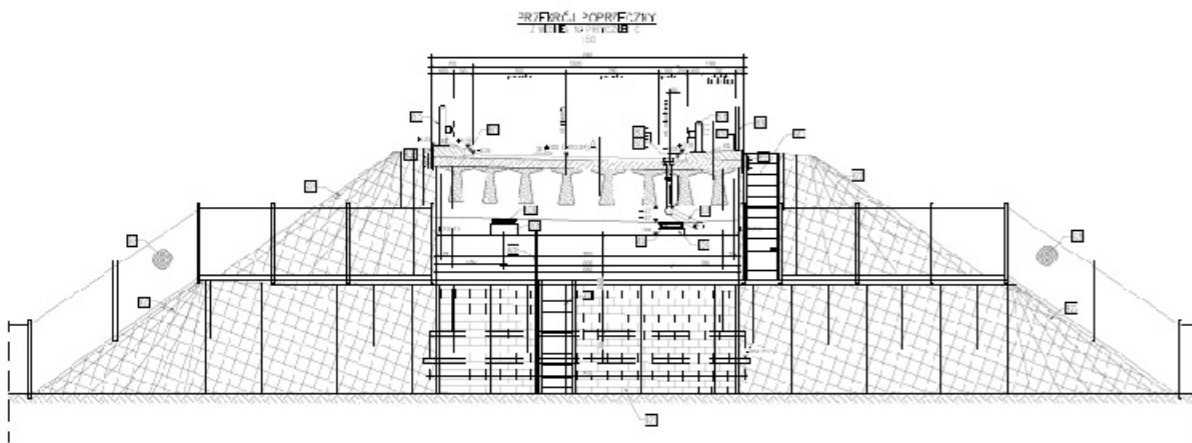
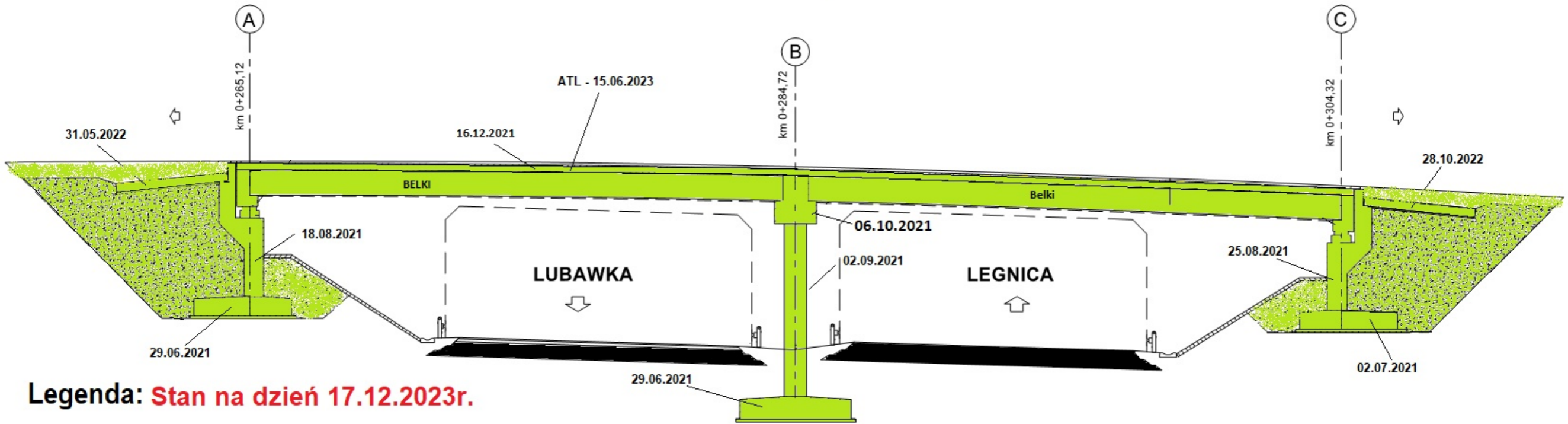

WS-24

km 41+431,41

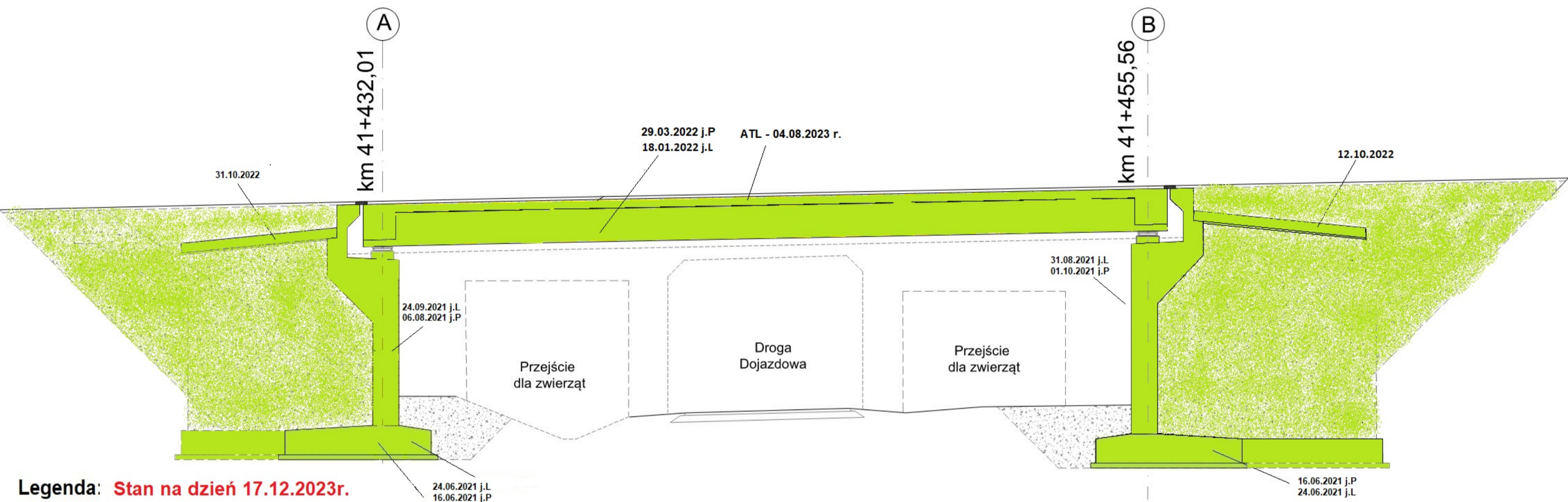

Legenda: **Stan na dzień 17.12.2023r.**

- Roboty w trakcie wykonywania
- Roboty zakończone



MS-25

km 41+996,65

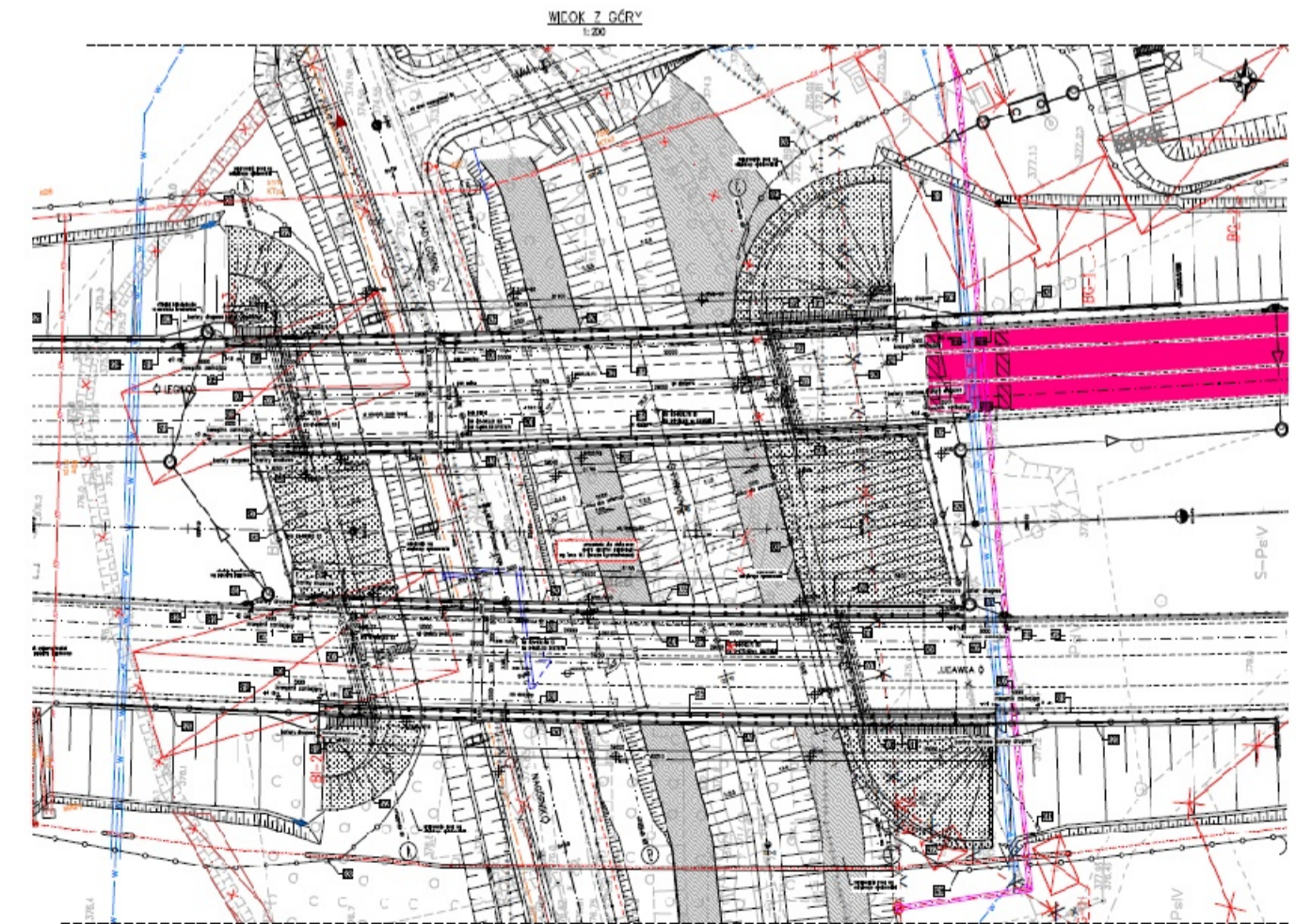
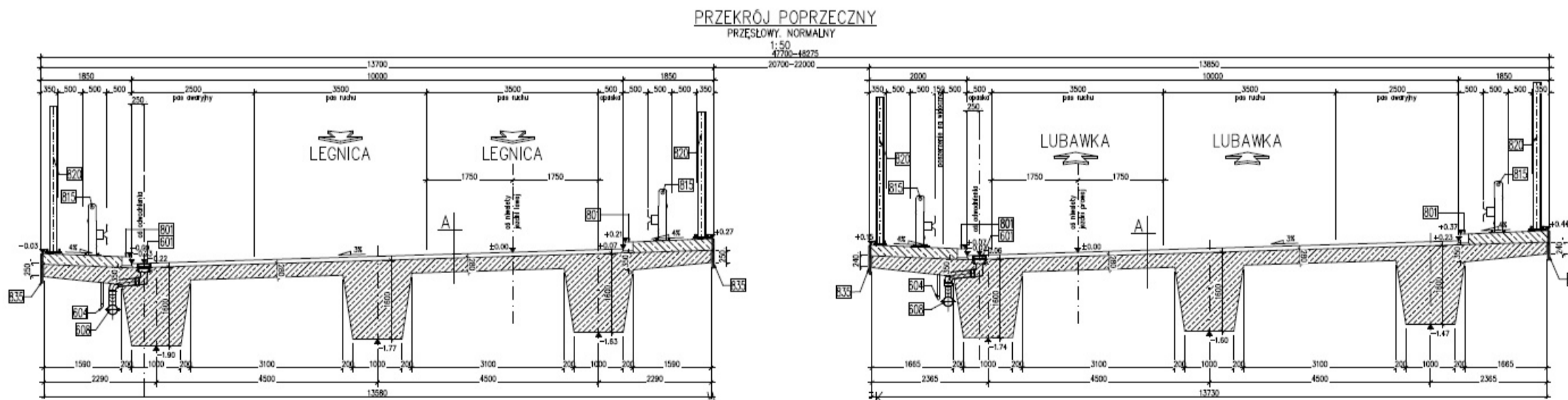
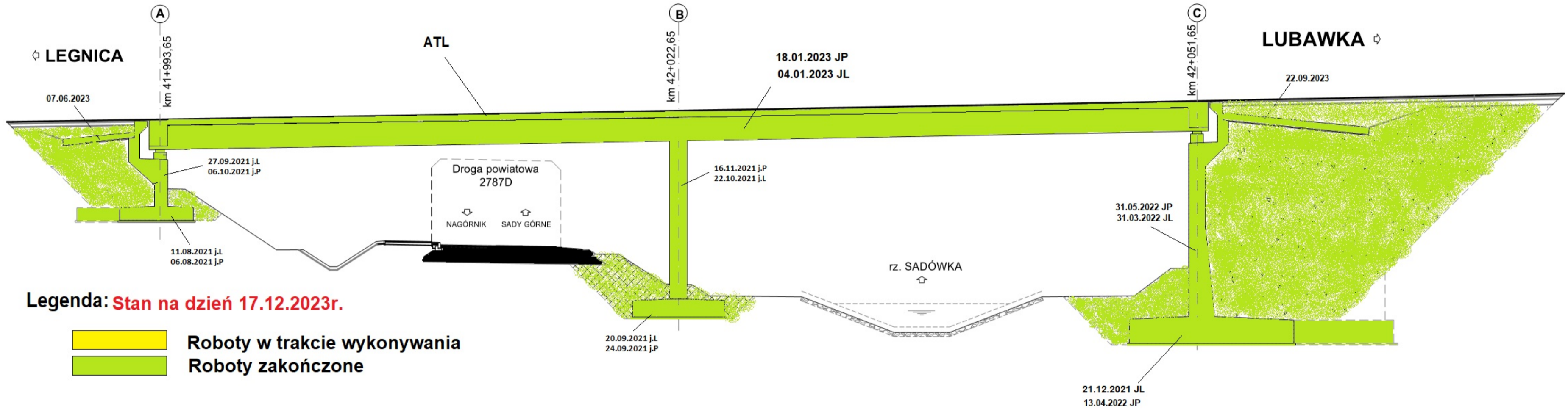

WD-27

km 44+702,77

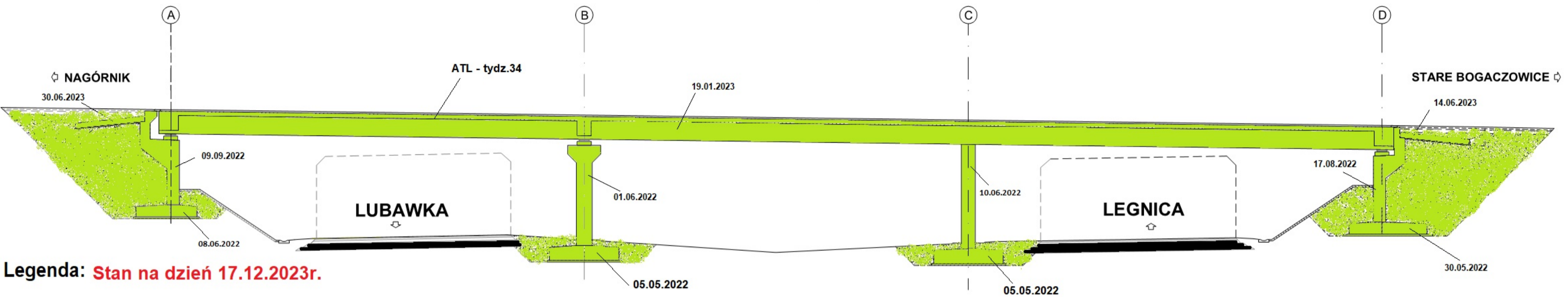

PRZEKRÓJ POPRZECZNY
Z WIDOKIEM NA FILAR
1:50

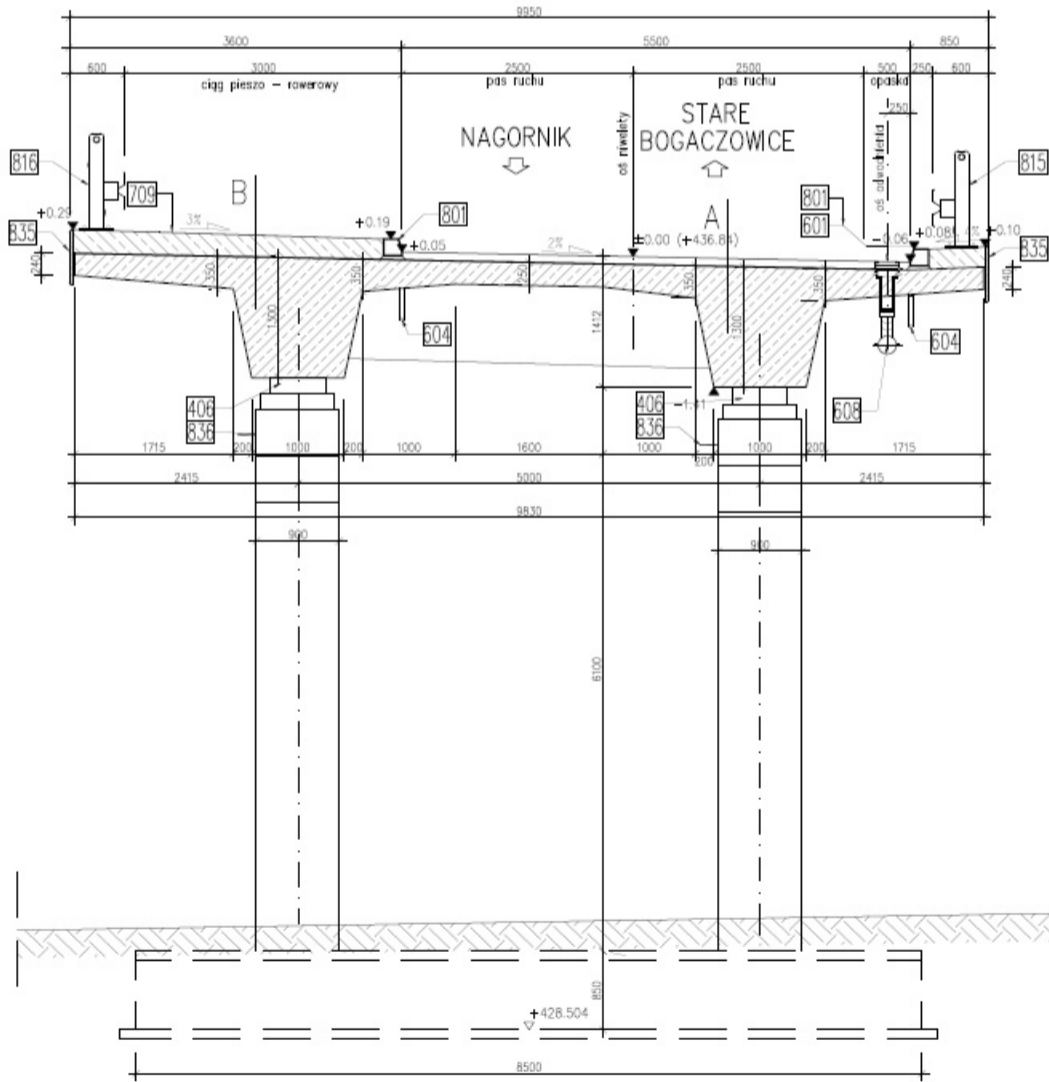

WIDOK Z GÓRY
1:200

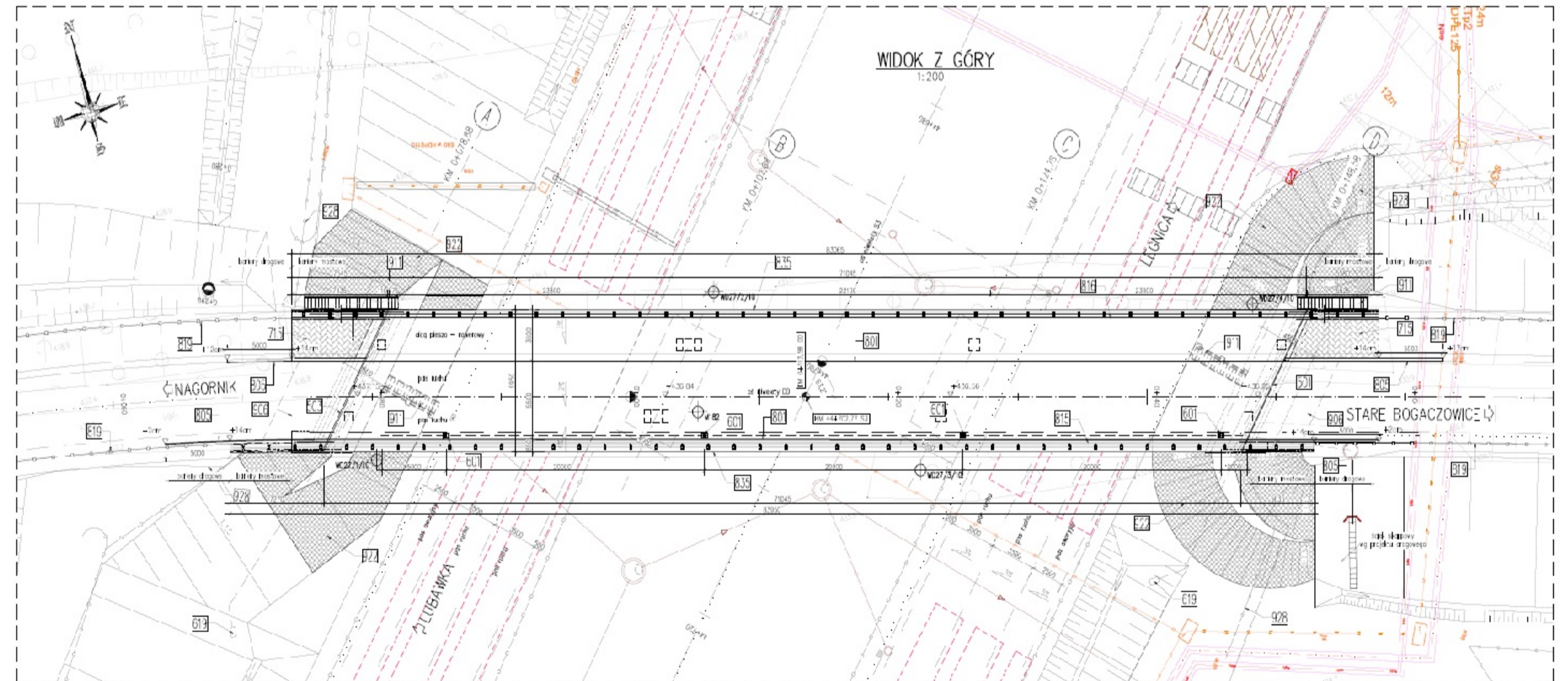

PG-29

km 46+743,46

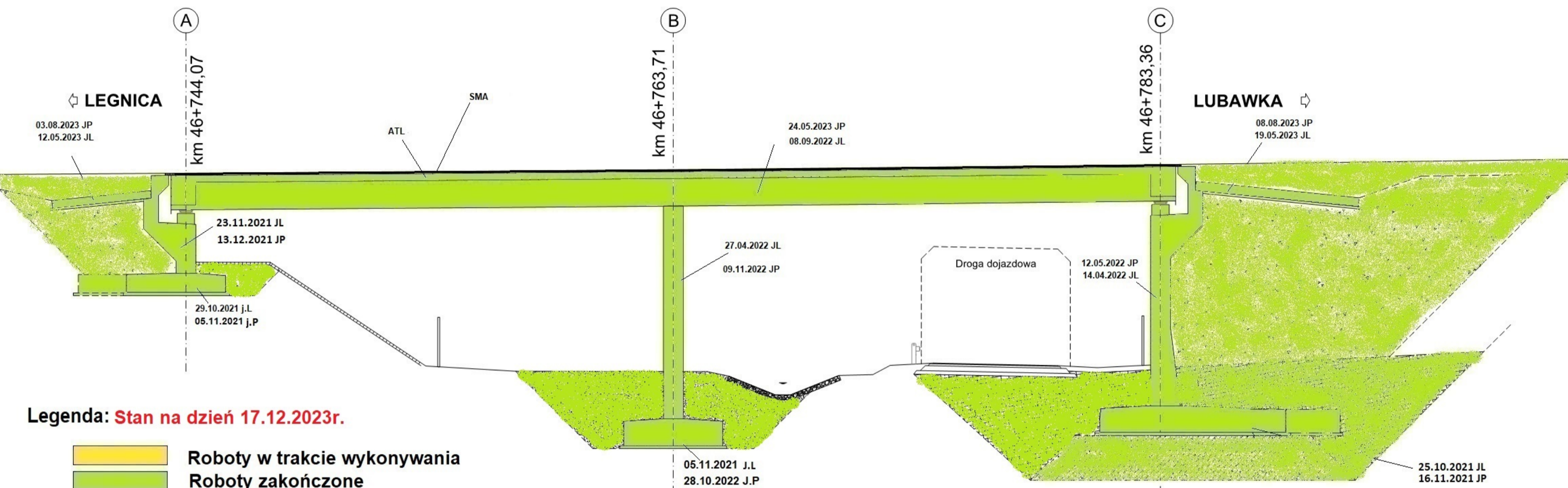

PRZEKRÓJ POPRZECZNY
PRZEŚLONY NORMALNY
1:50

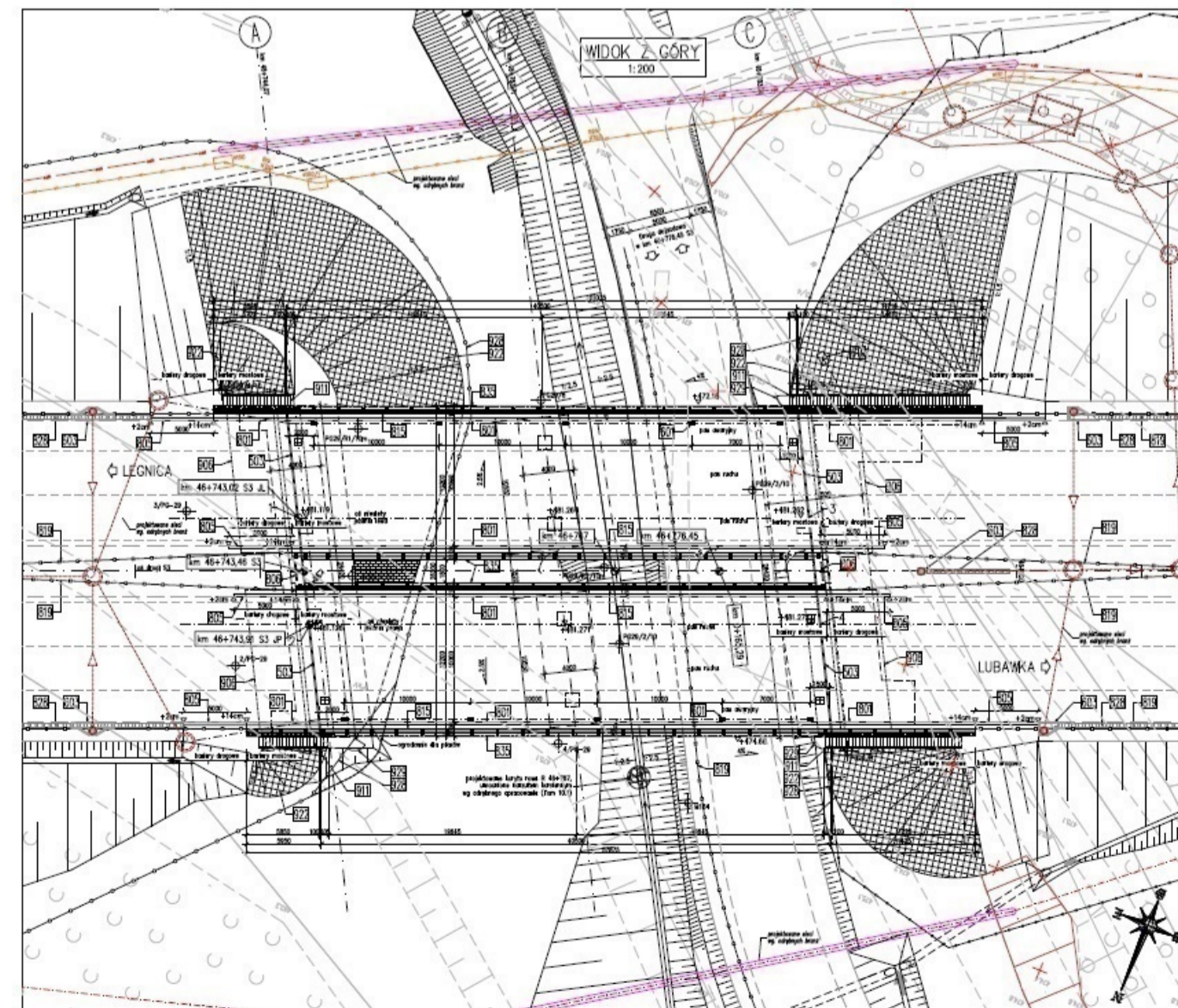
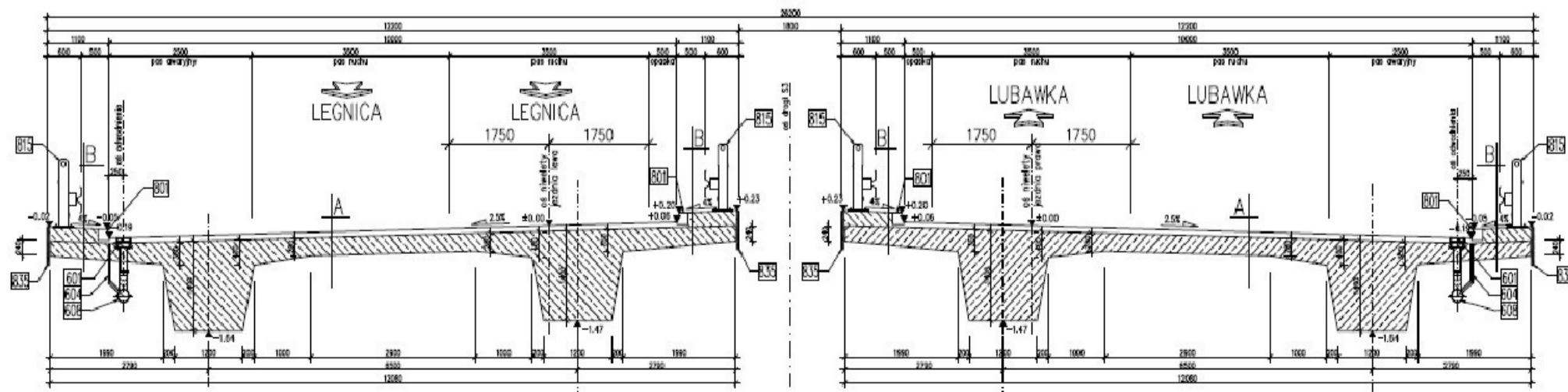

WS-30

km 46+908.42

Legenda Stan na dzień 17.12.2023r.

- Roboty w trakcie wykonywania
- Roboty zakończone

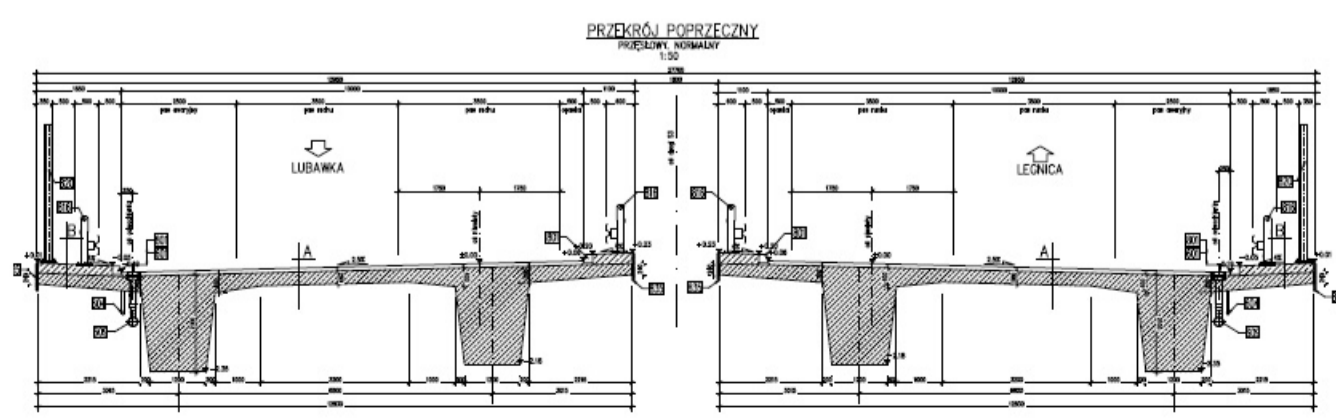
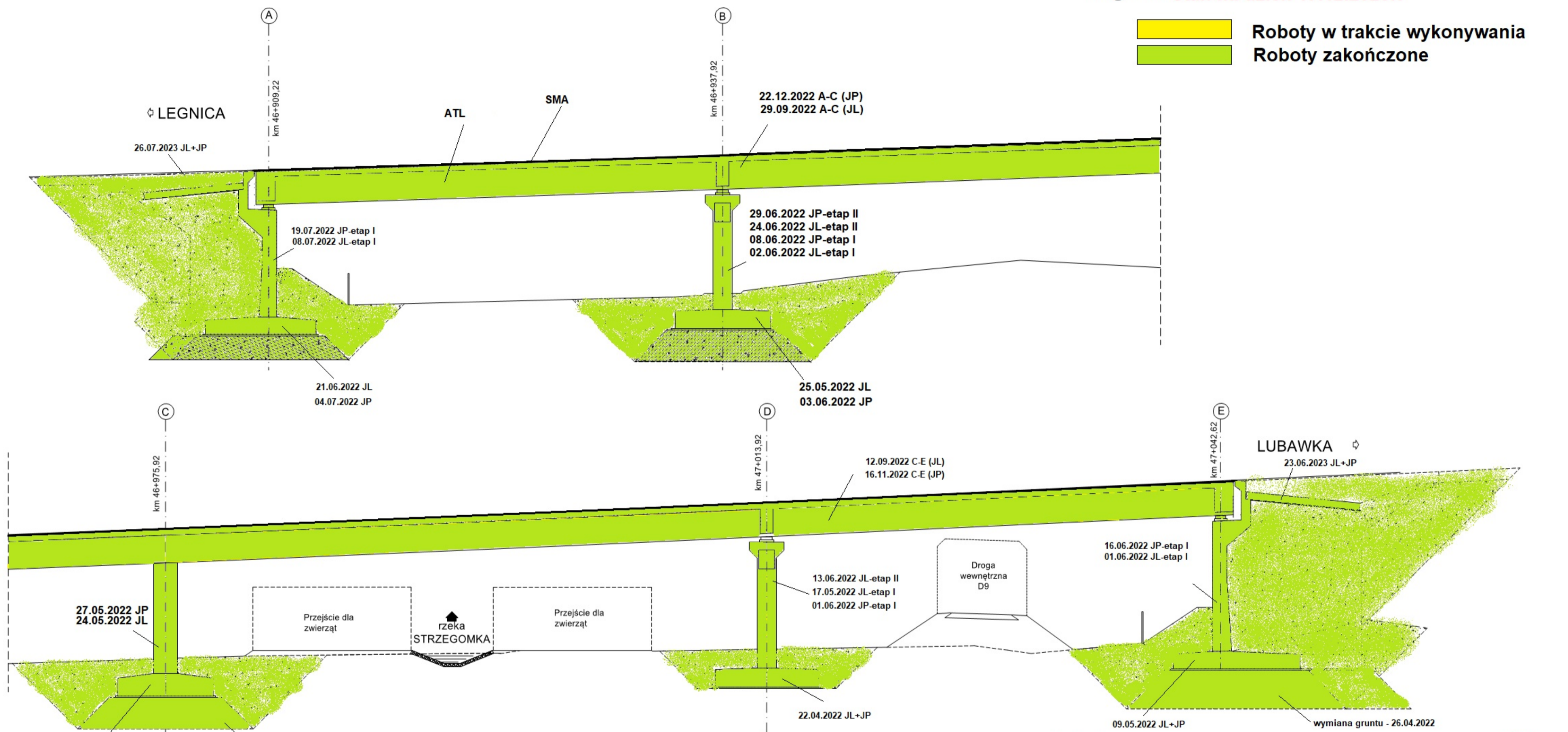

WS-31 km 47+568,12

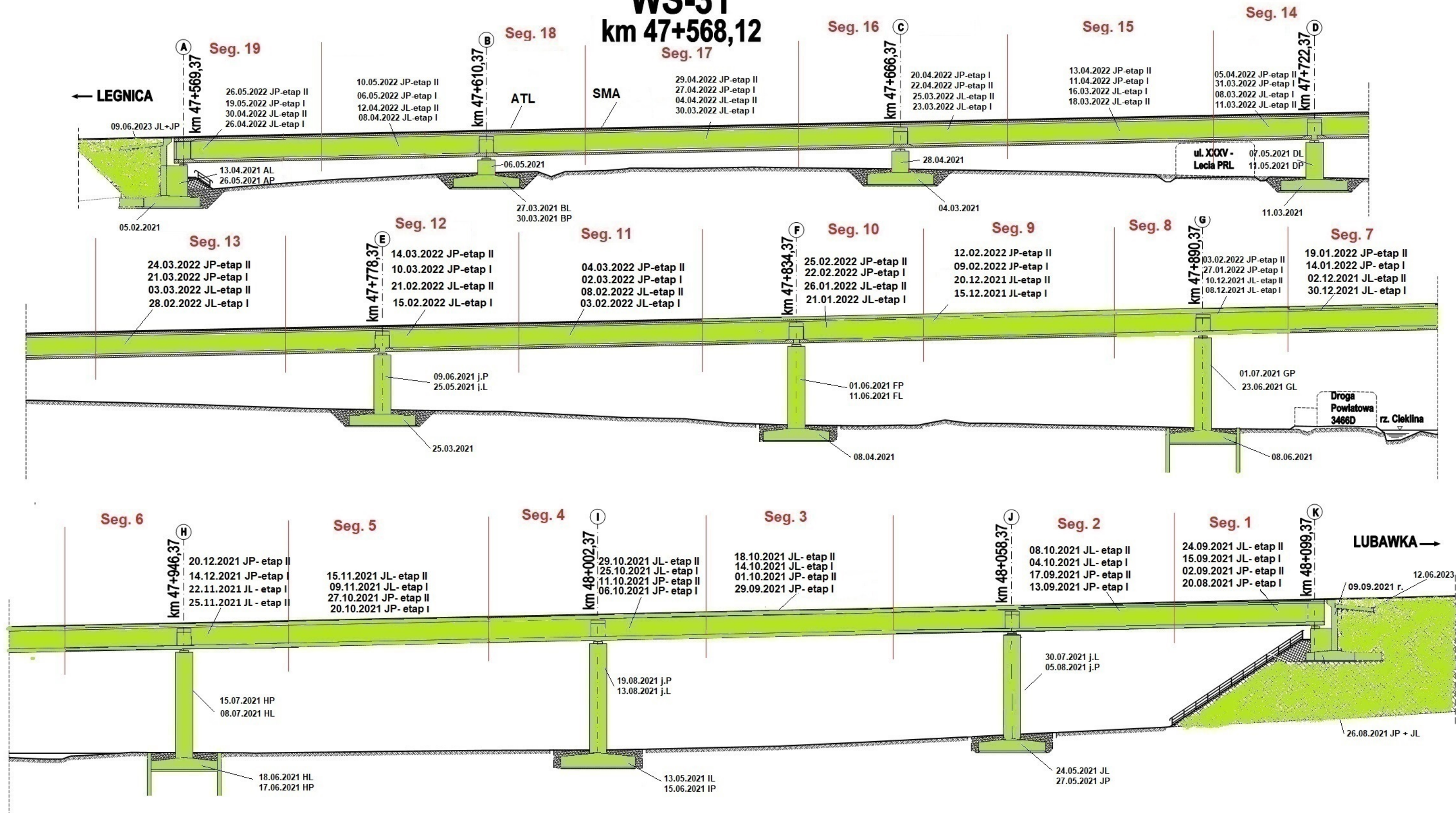

Legenda: Stan na dzień 17.12.2023r.

- Roboty w trakcie
- Roboty zakończone

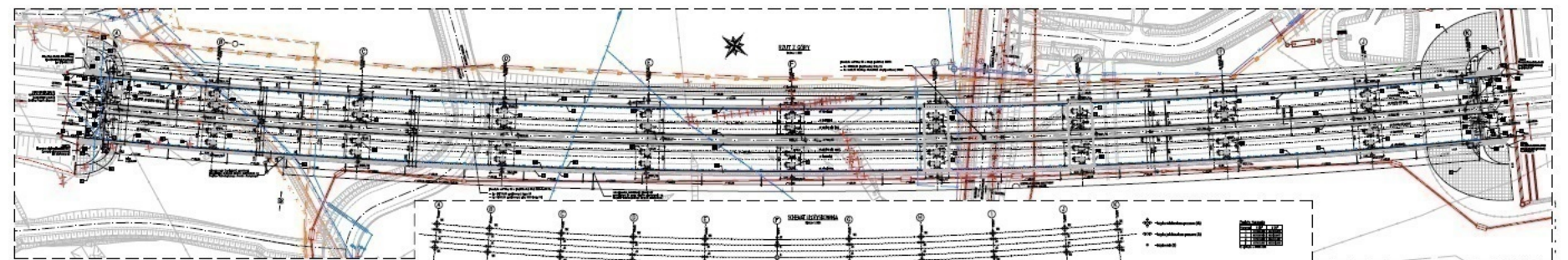
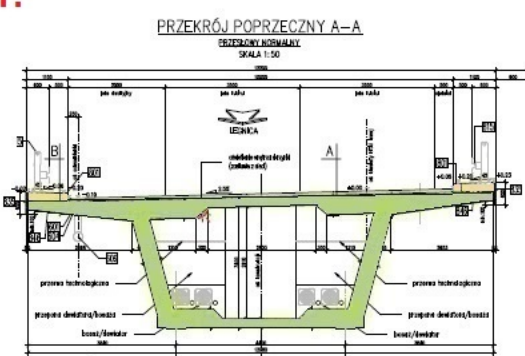

PG 10.1

km 50+097,00

← LEGNICA SMA → LUBAWKA →

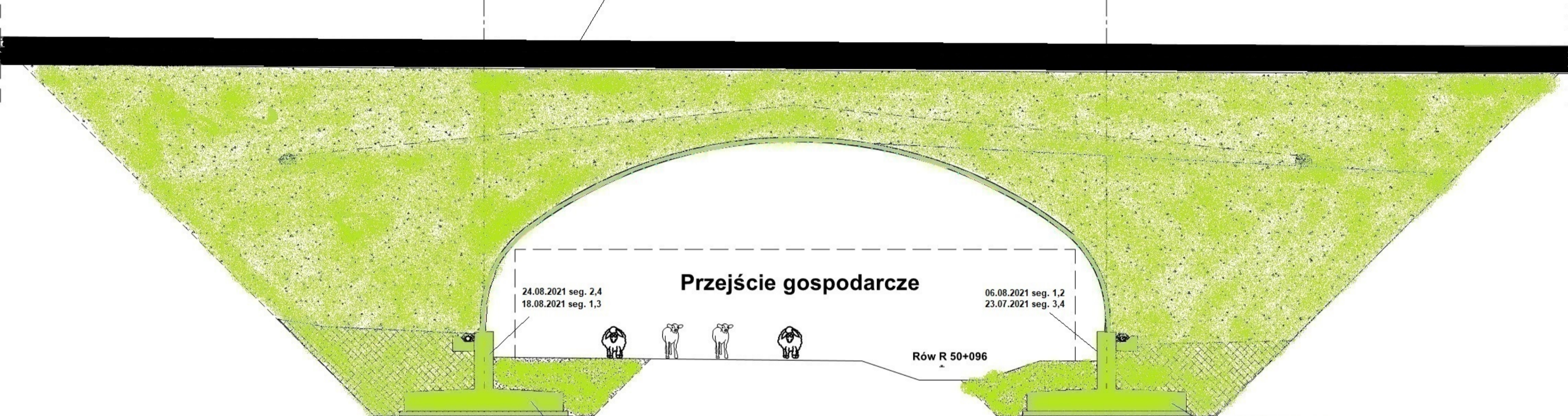

Legenda: Stan na dzień 17.12.2023r.

- Roboty w trakcie wykonywania
- Roboty zakończone

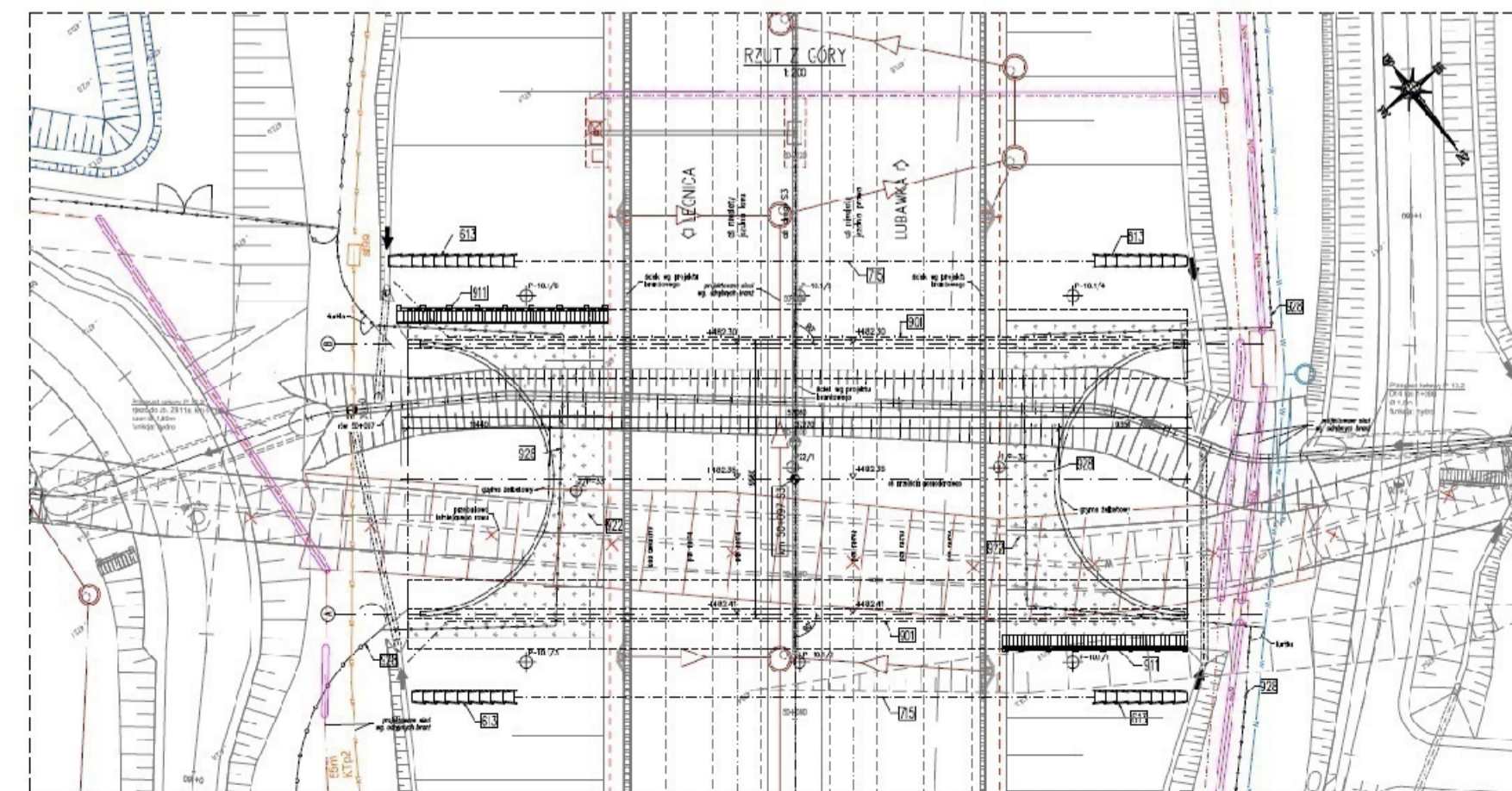
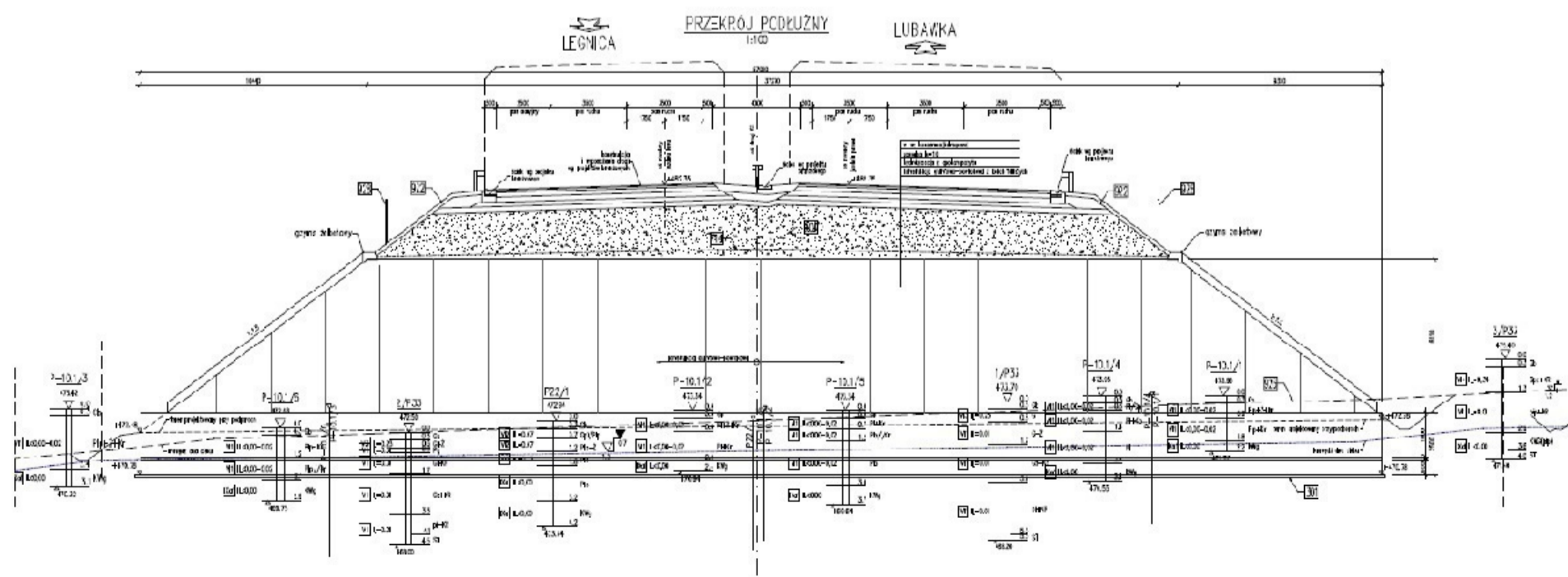

WS-33
km 49+530,70

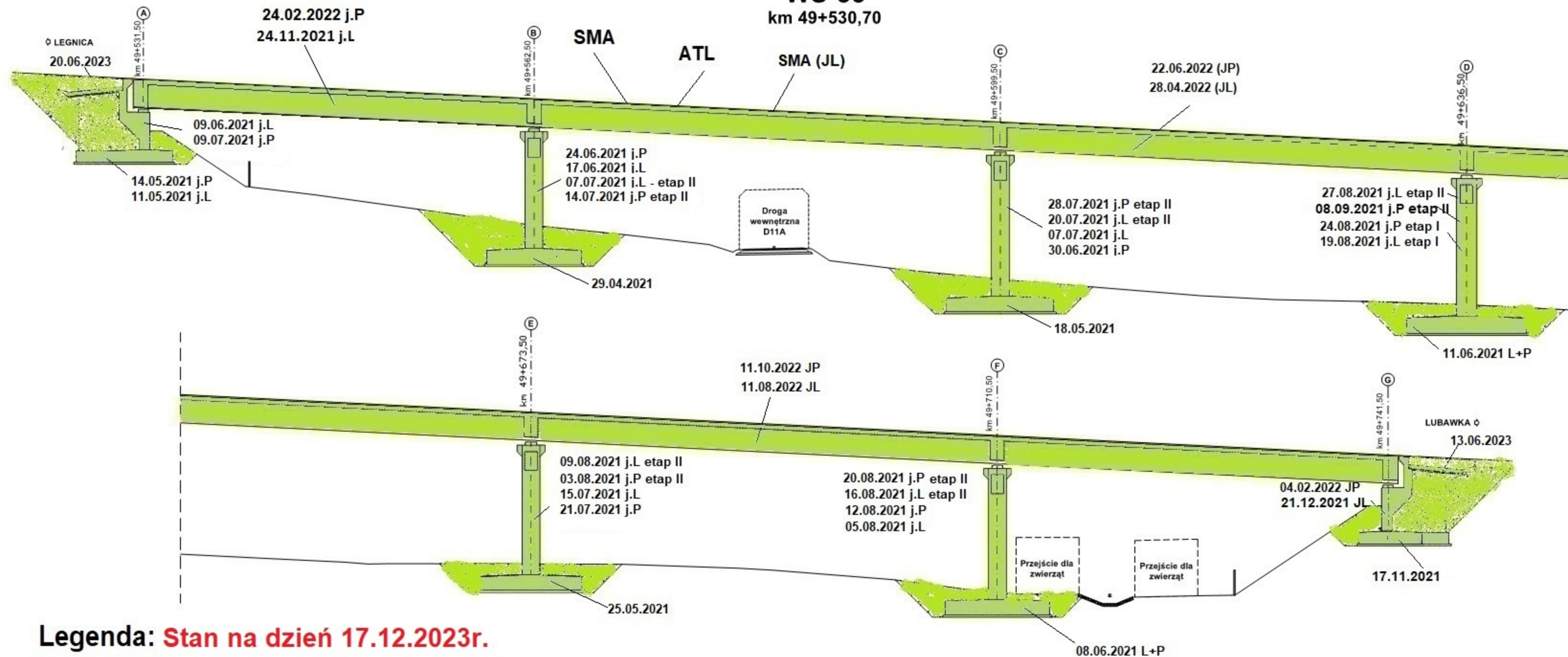

Legenda: Stan na dzień 17.12.2023r.

- Roboty w trakcie wykonywania
- Roboty zakończone

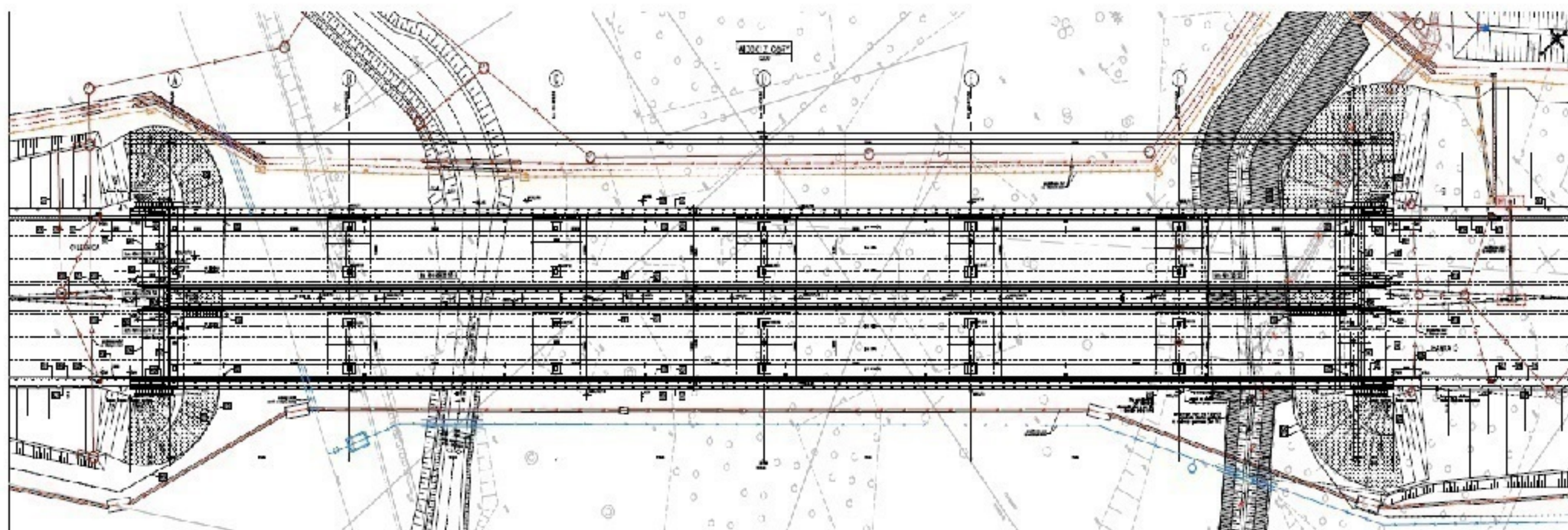
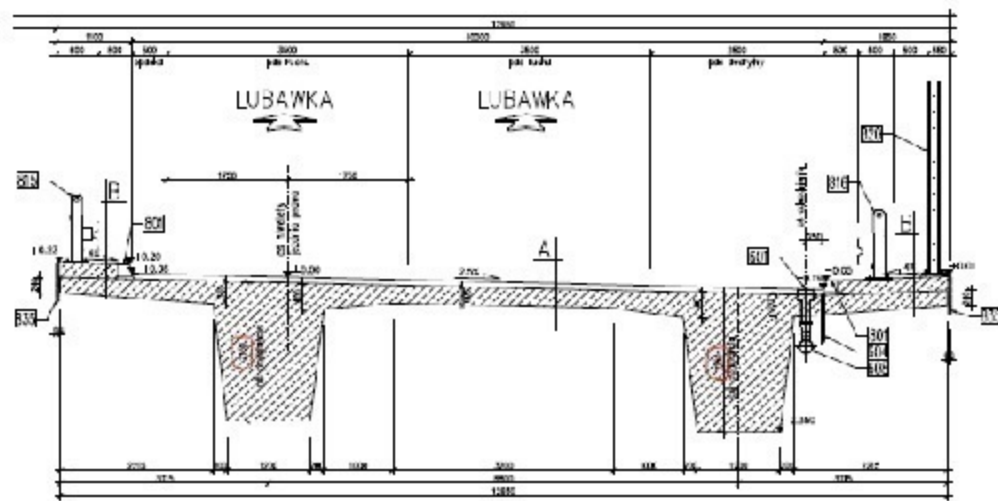

WD-34

km 50+661,15

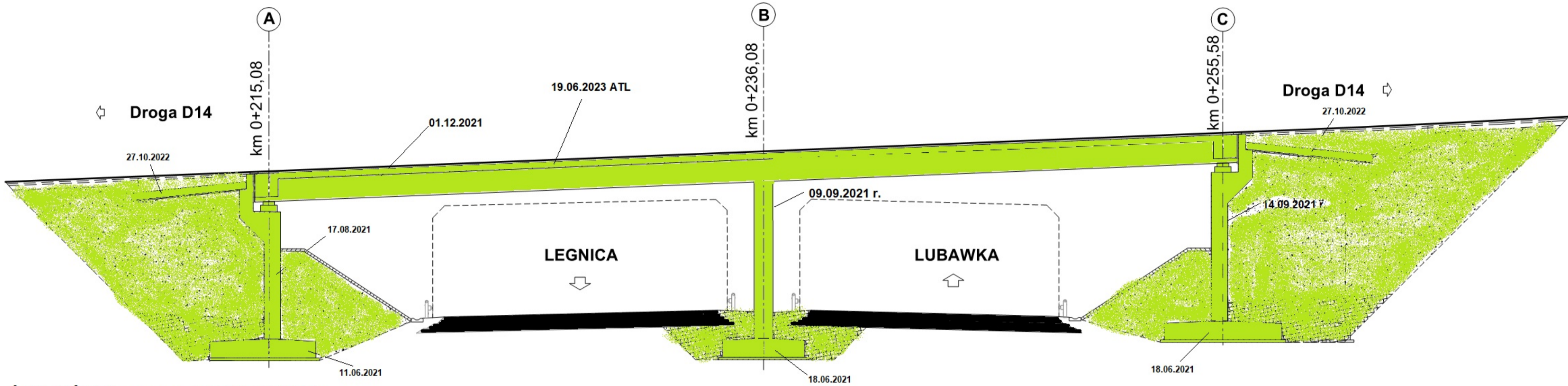

- Roboty w trakcie wykonywania
- Roboty zakończone

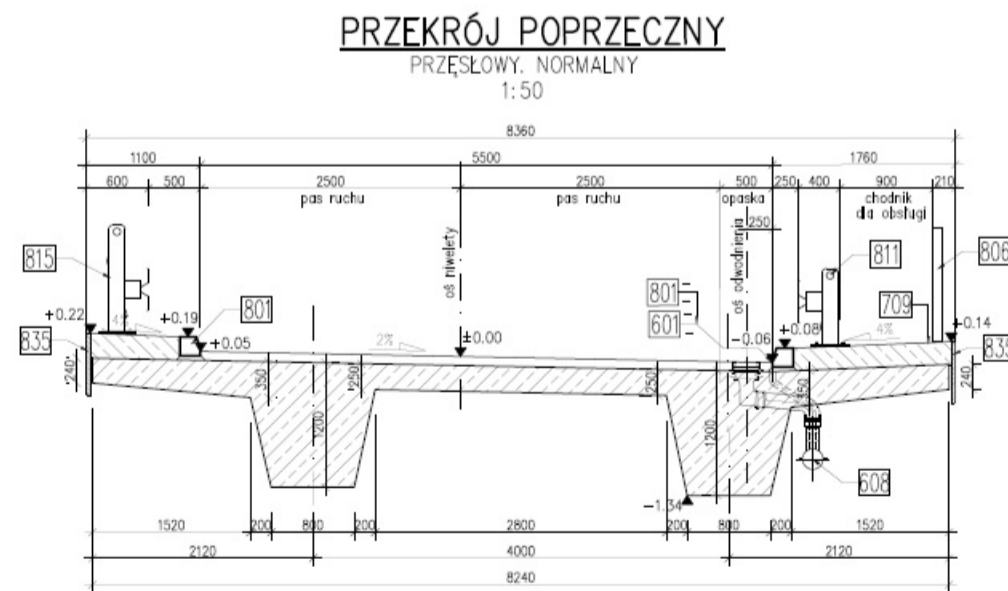

PG 11.1

km 51+249,00

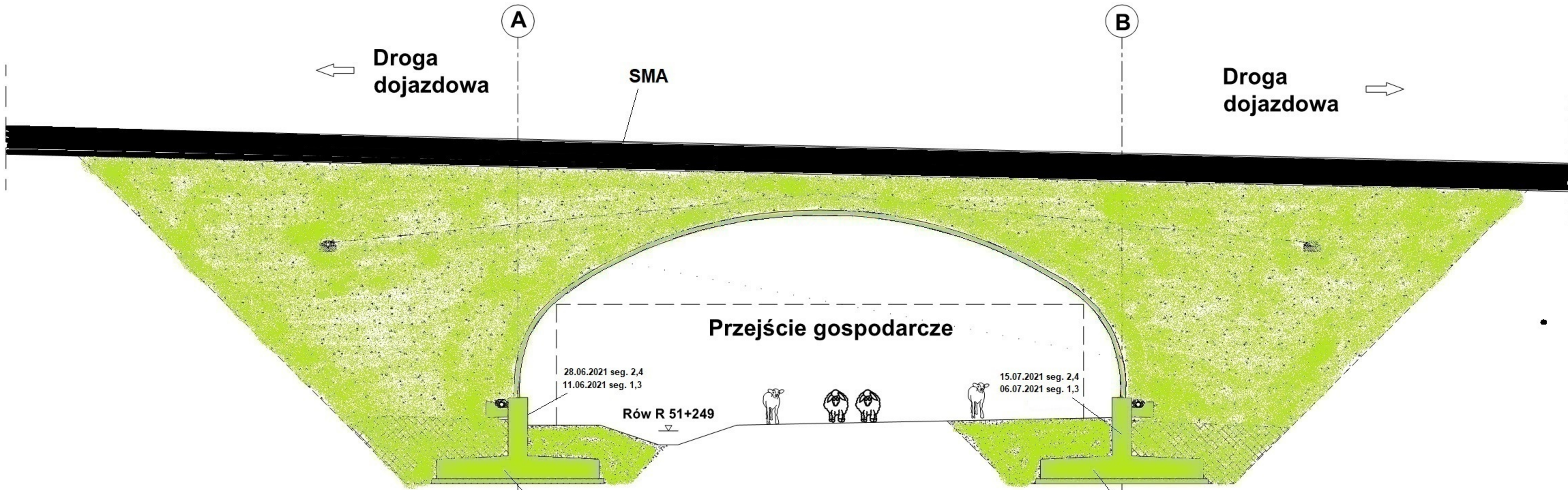

Legenda: Stan na dzień 17.12.2023r.

- Roboty w trakcie wykonywania
- Roboty zakończone

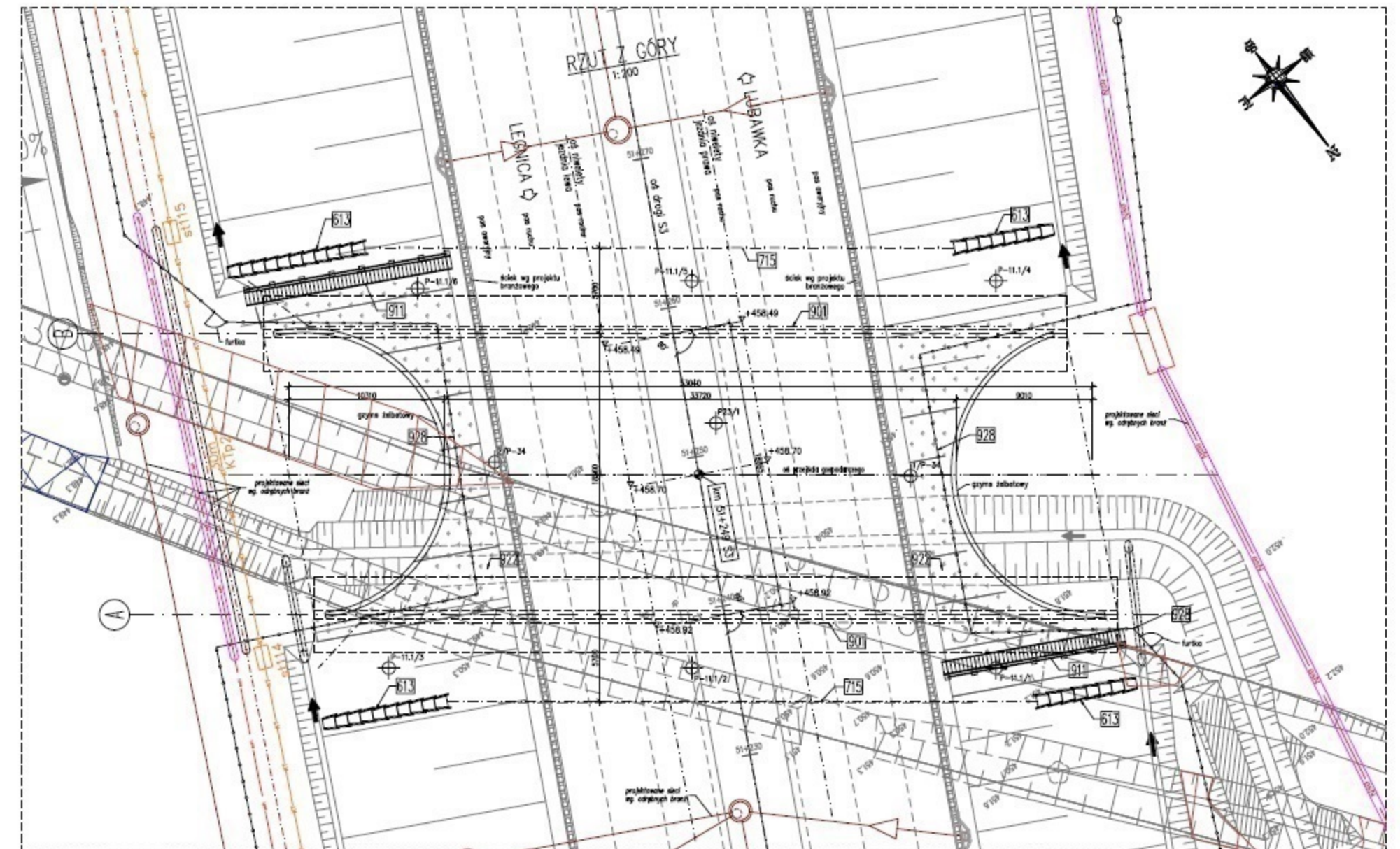
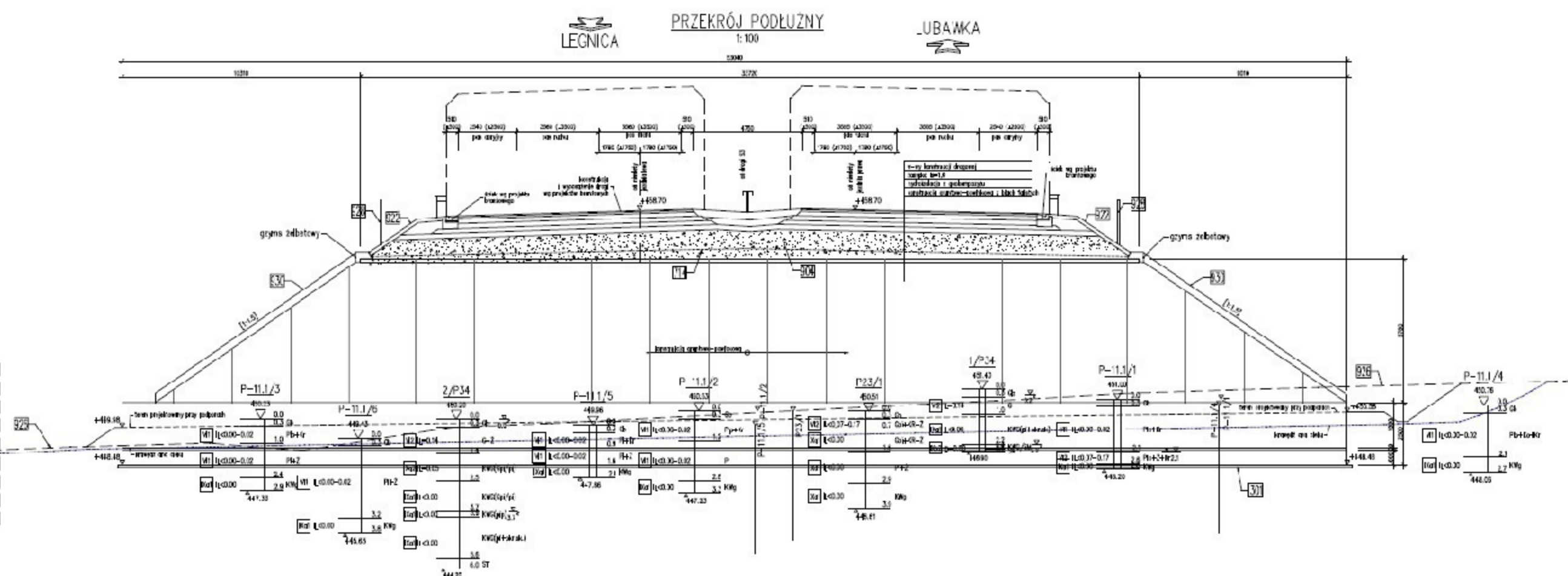

WS-36 km 51+780,95

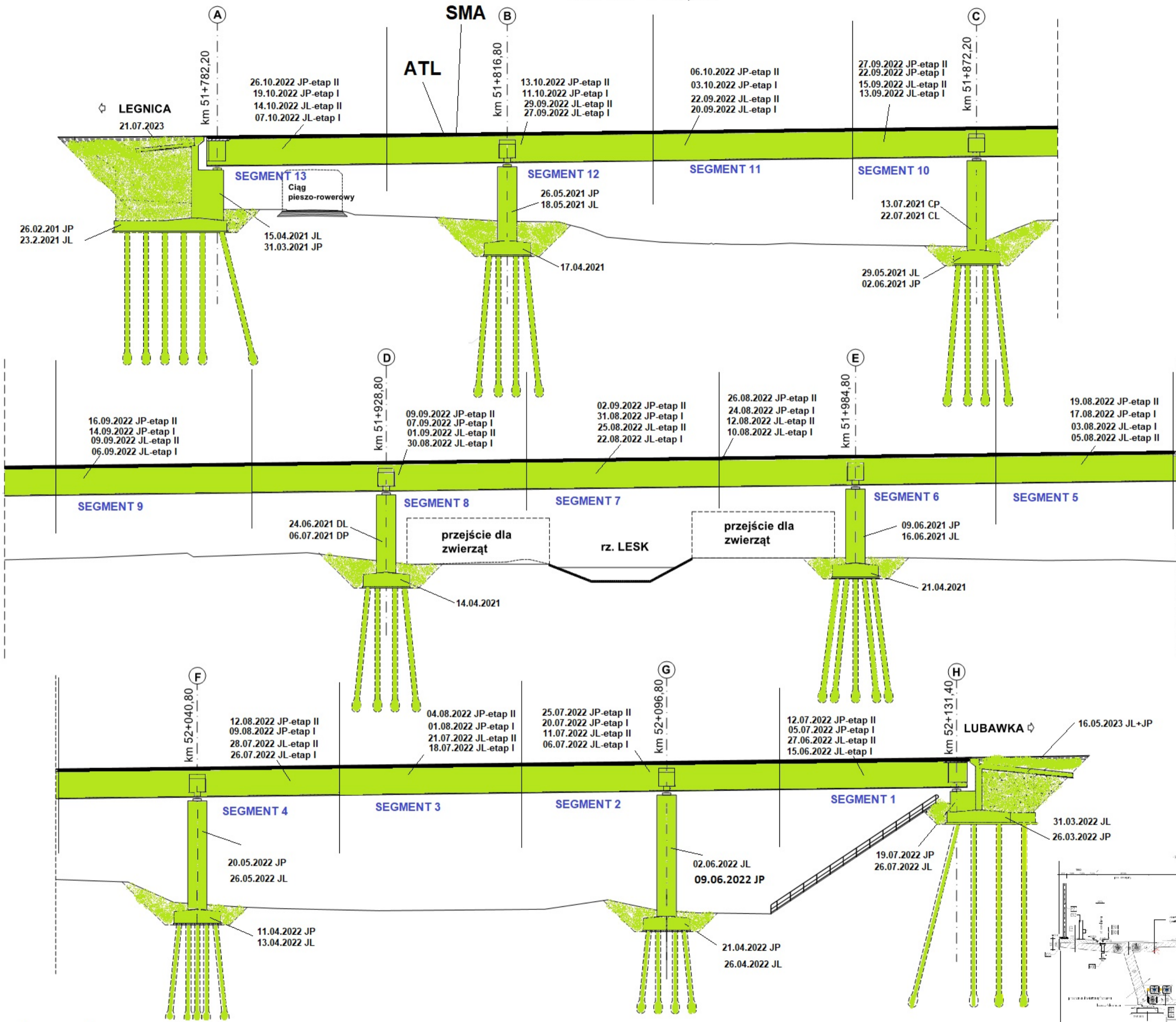

Legenda: Stan na dzień 17.12.2023r.

- Roboty w trakcie wykonywania
- Roboty zakończone

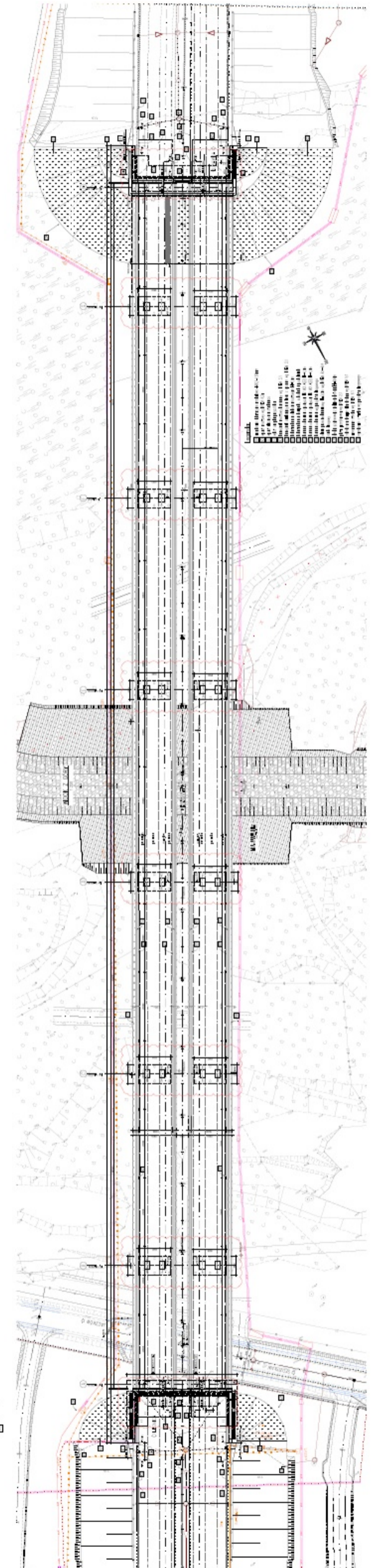
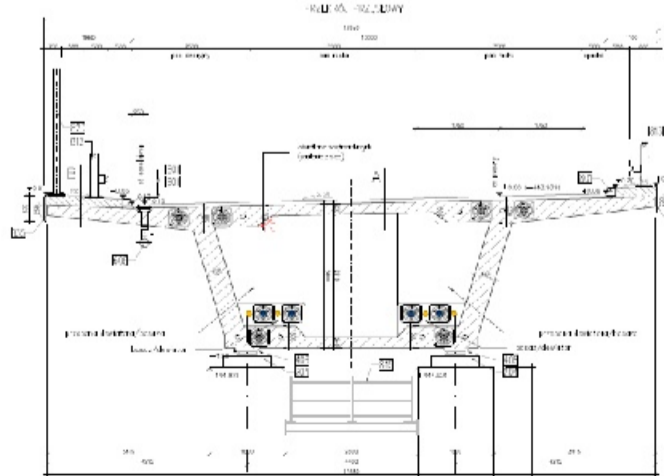

WS-37

km 52+994,25

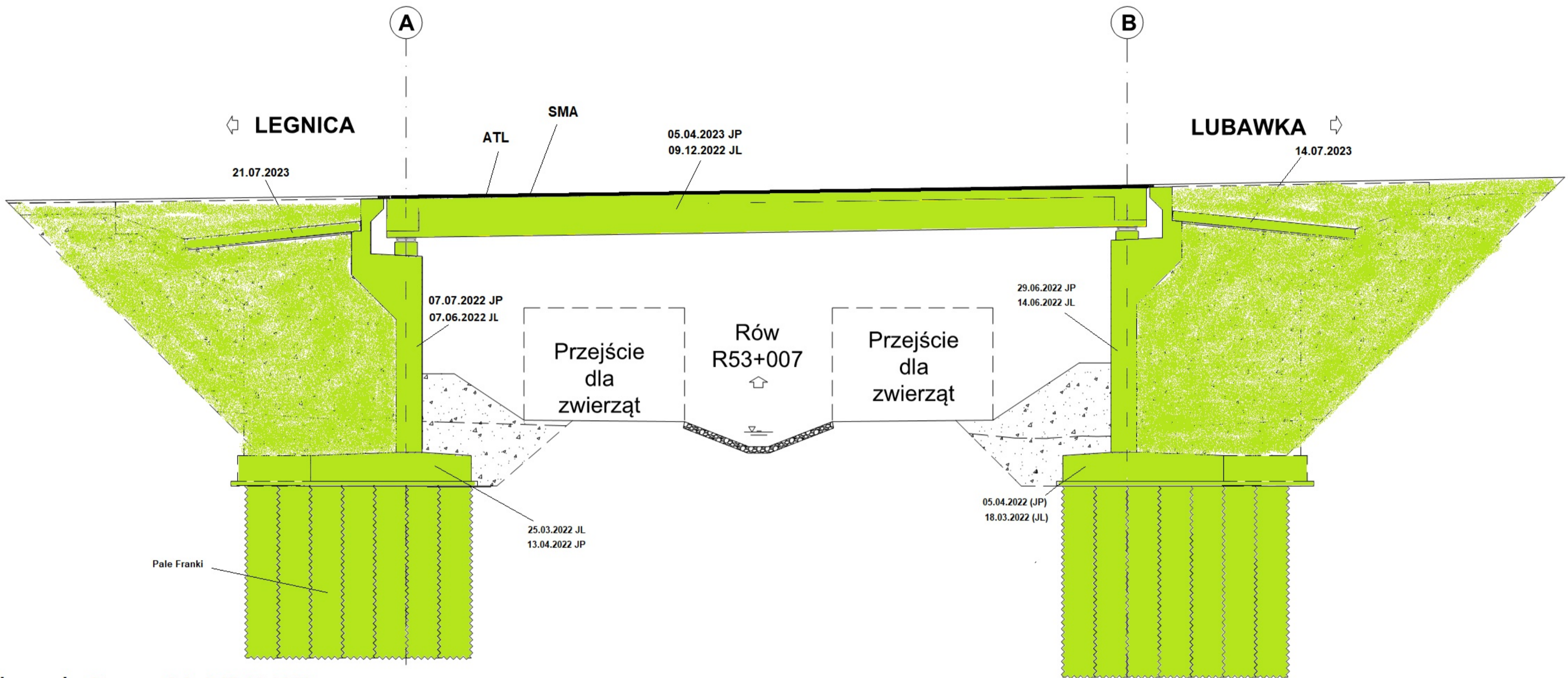

Legenda: Stan na dzień 17.12.2023r.

- Roboty w trakcie wykonywania
- Roboty zakończone

PRZEKRÓJ POPRZECZNY
PRZEŚLONY, NORMALNY
1:50

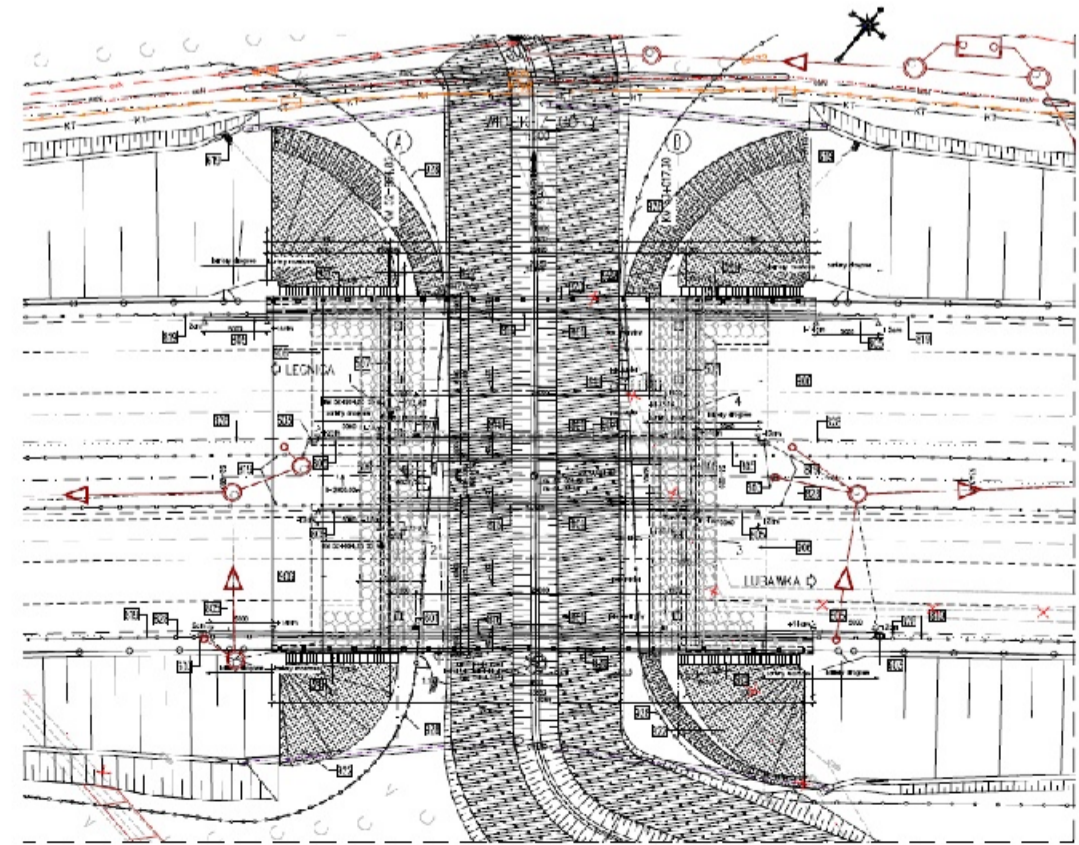
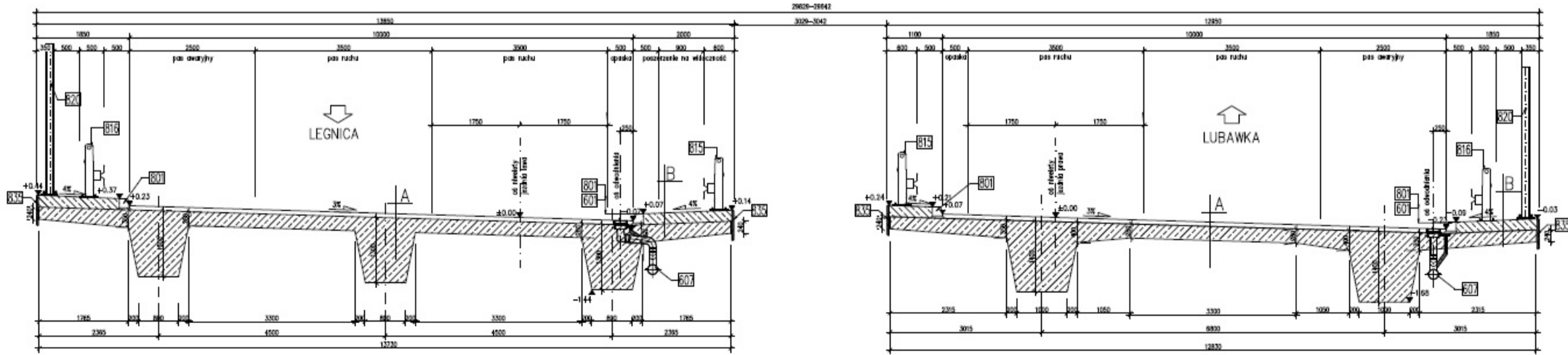

WD-38

km 53+798,79

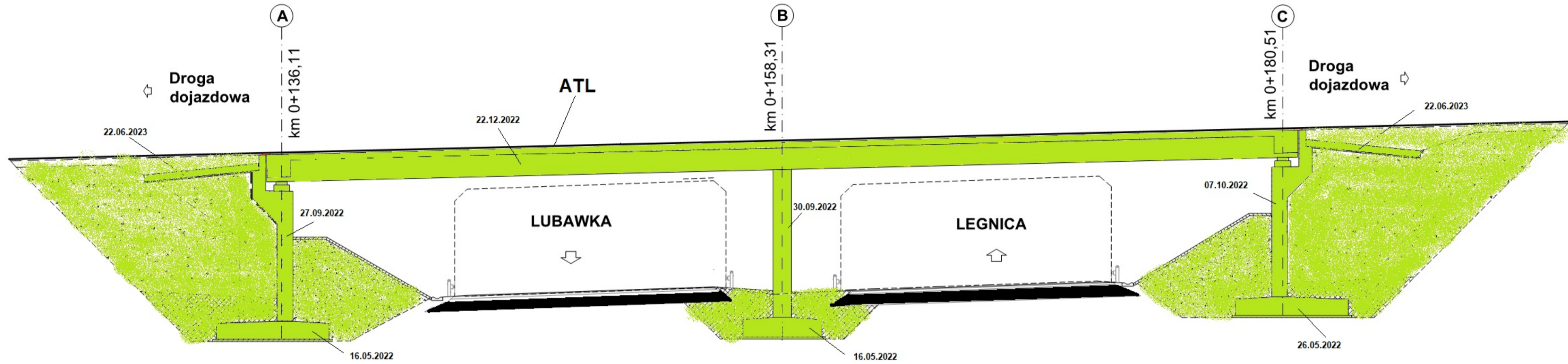

Legenda Stan na dzień 17.12.2023r.

- Roboty w trakcie wykonywania
- Roboty zakończone

PRZEKRÓJ POPRZECZNY
PRZESŁONY NORMATYWNY
1:30

