

# WD-22

## km 38+491,21

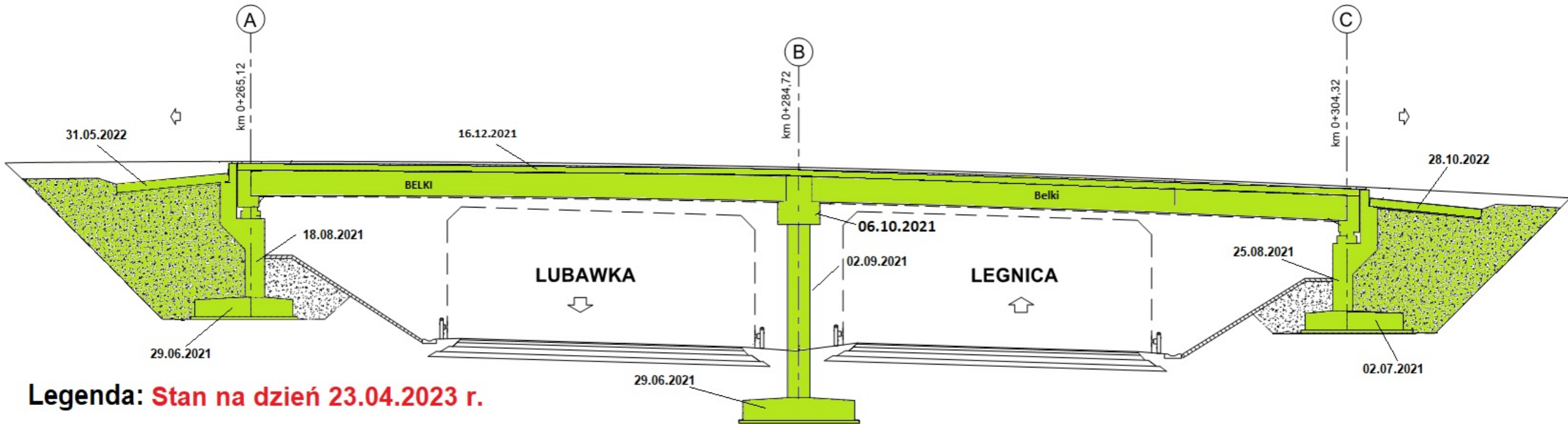

Legenda: **Stan na dzień 23.04.2023 r.**

-  Roboty w trakcie wykonywania
-  Roboty zakończone

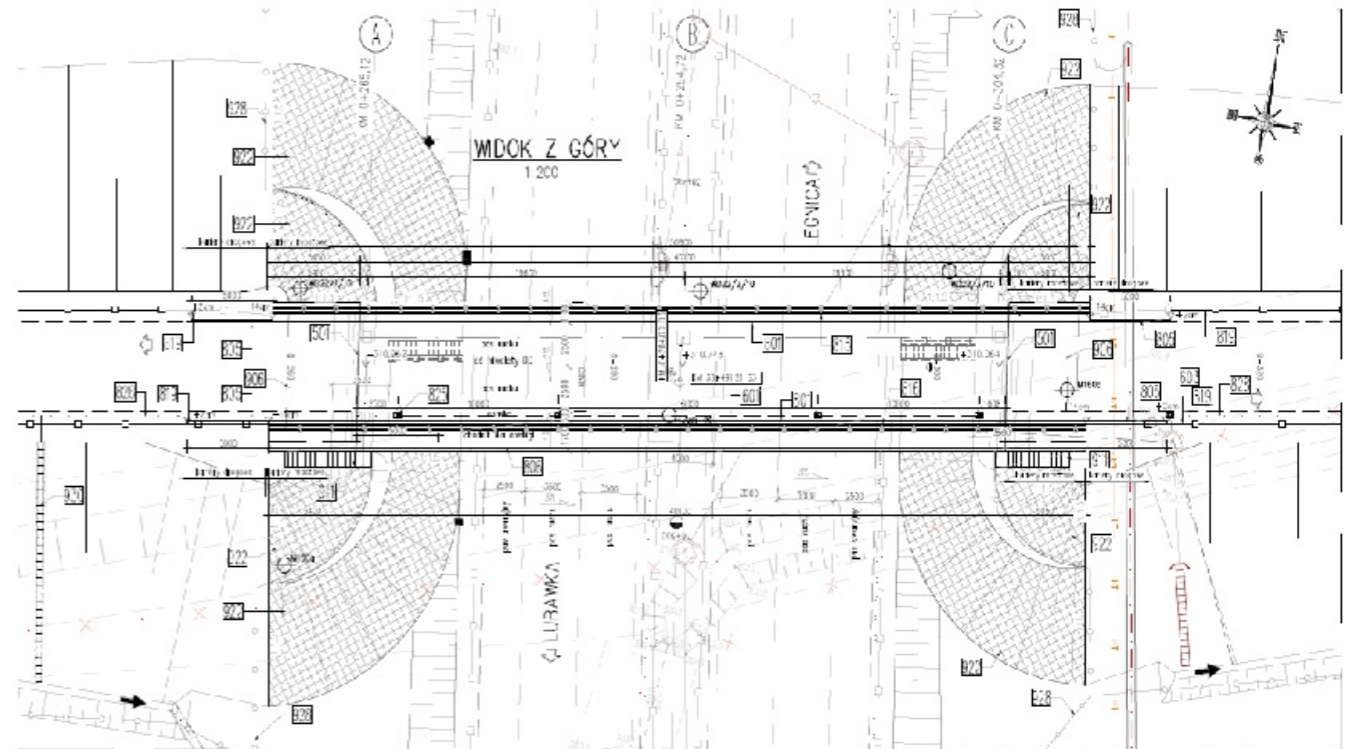
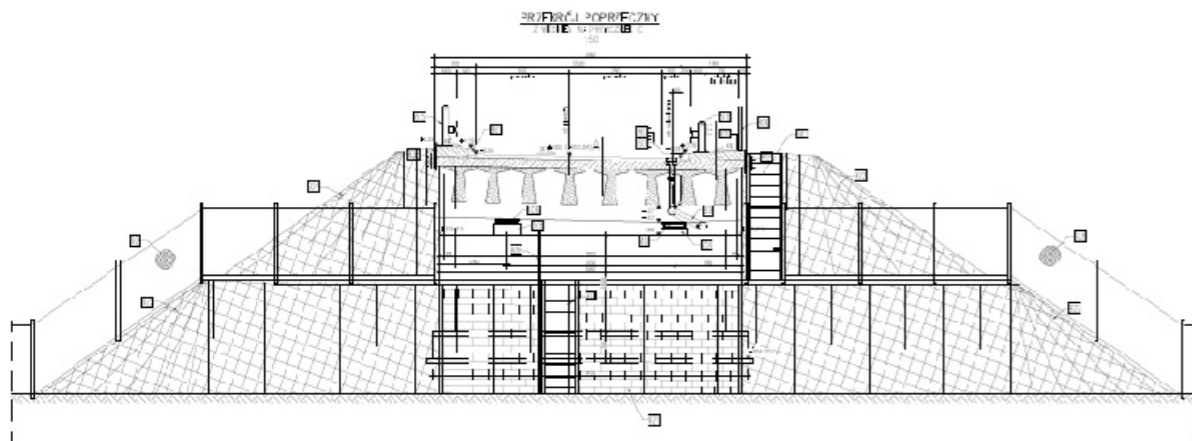

# WS-24

km 41+431,41

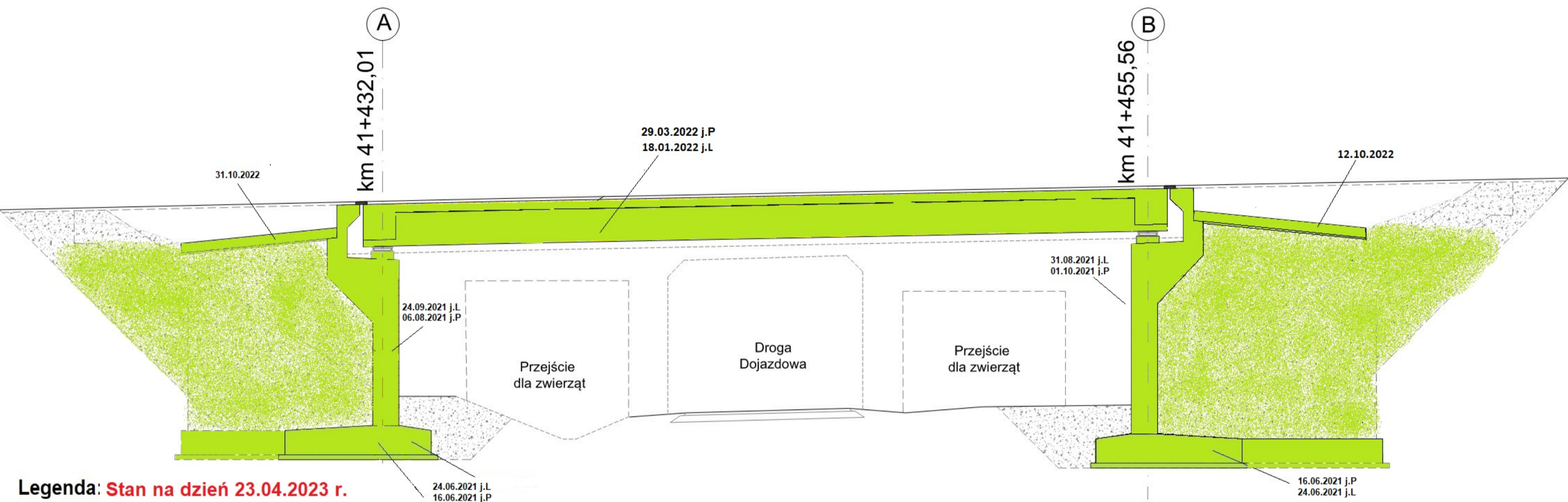

Legenda: Stan na dzień 23.04.2023 r.

- Roboty w trakcie wykonywania
- Roboty zakończone



# MS-25

km 41+996,65

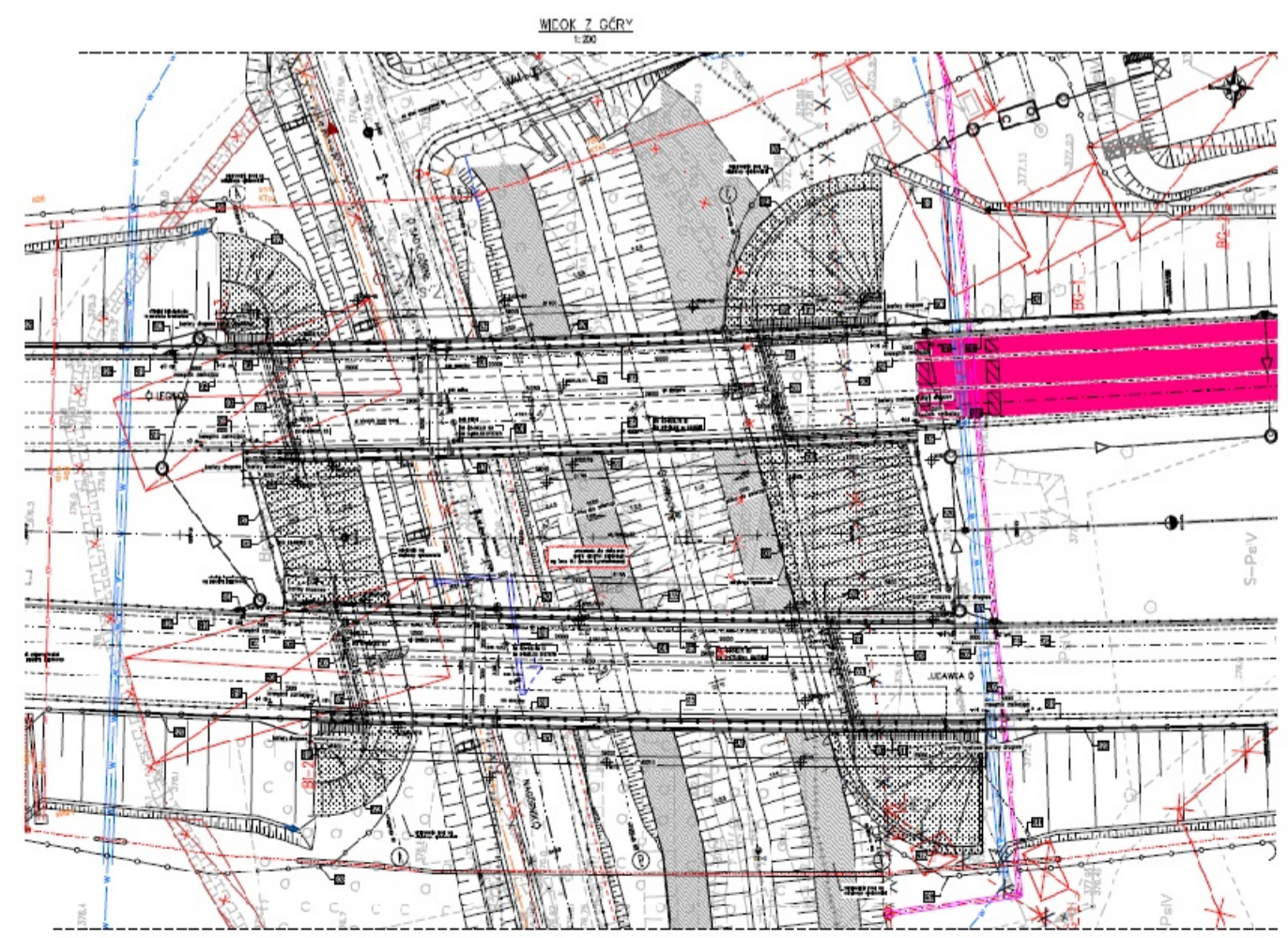
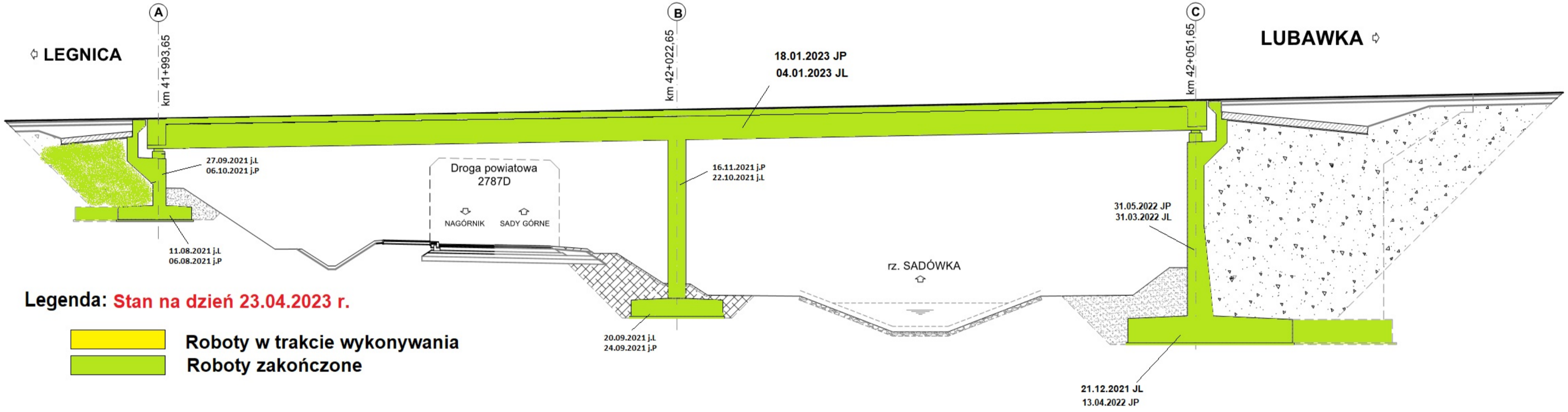

# WD-27

km 44+702,77

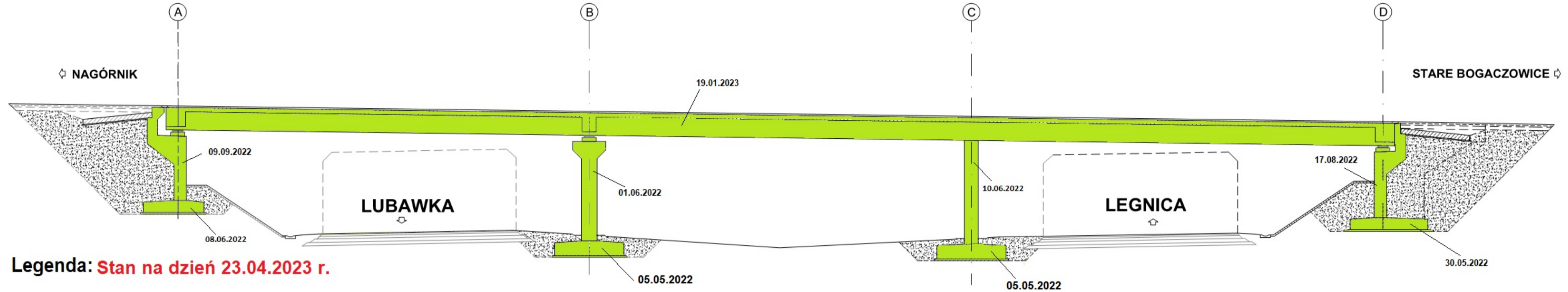

Legenda: Stan na dzień 23.04.2023 r.

- Roboty w trakcie wykonywania
- Roboty zakończone

PRZEKRÓJ POPRZECZNY  
Z WIDOKIEM NA FILAR  
1:50

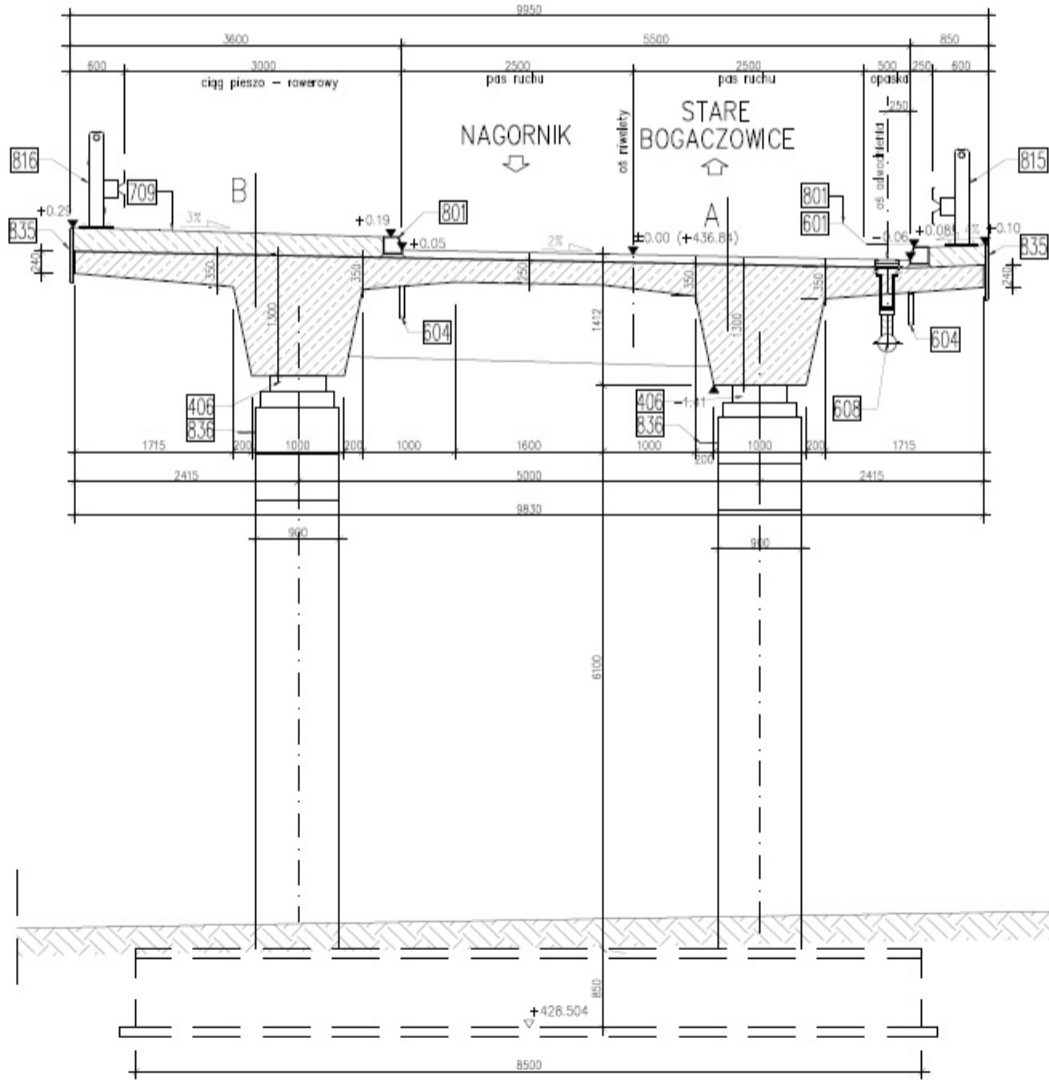

WIDOK Z GÓRY  
1:200

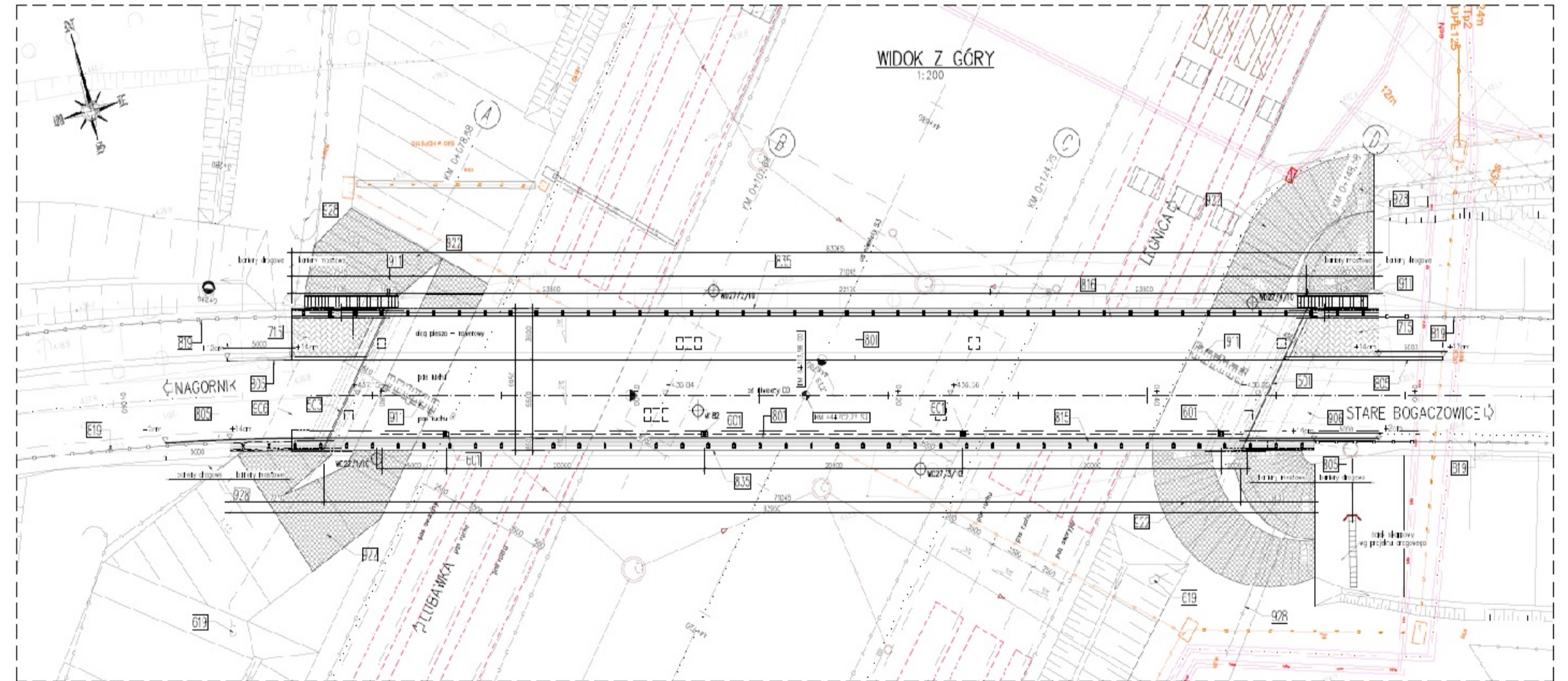

# PG-29

km 46+743,46

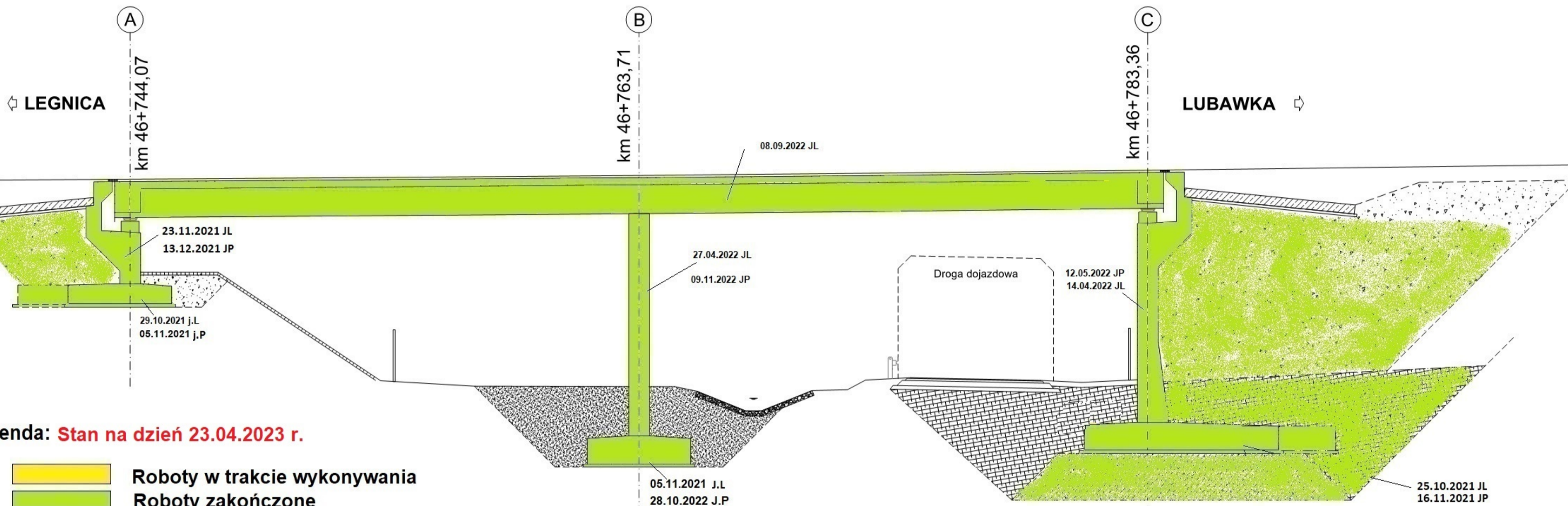

PRZEKRÓJ POPRZECZNY  
PRZEŚLÓWY NORMALNY  
1:50

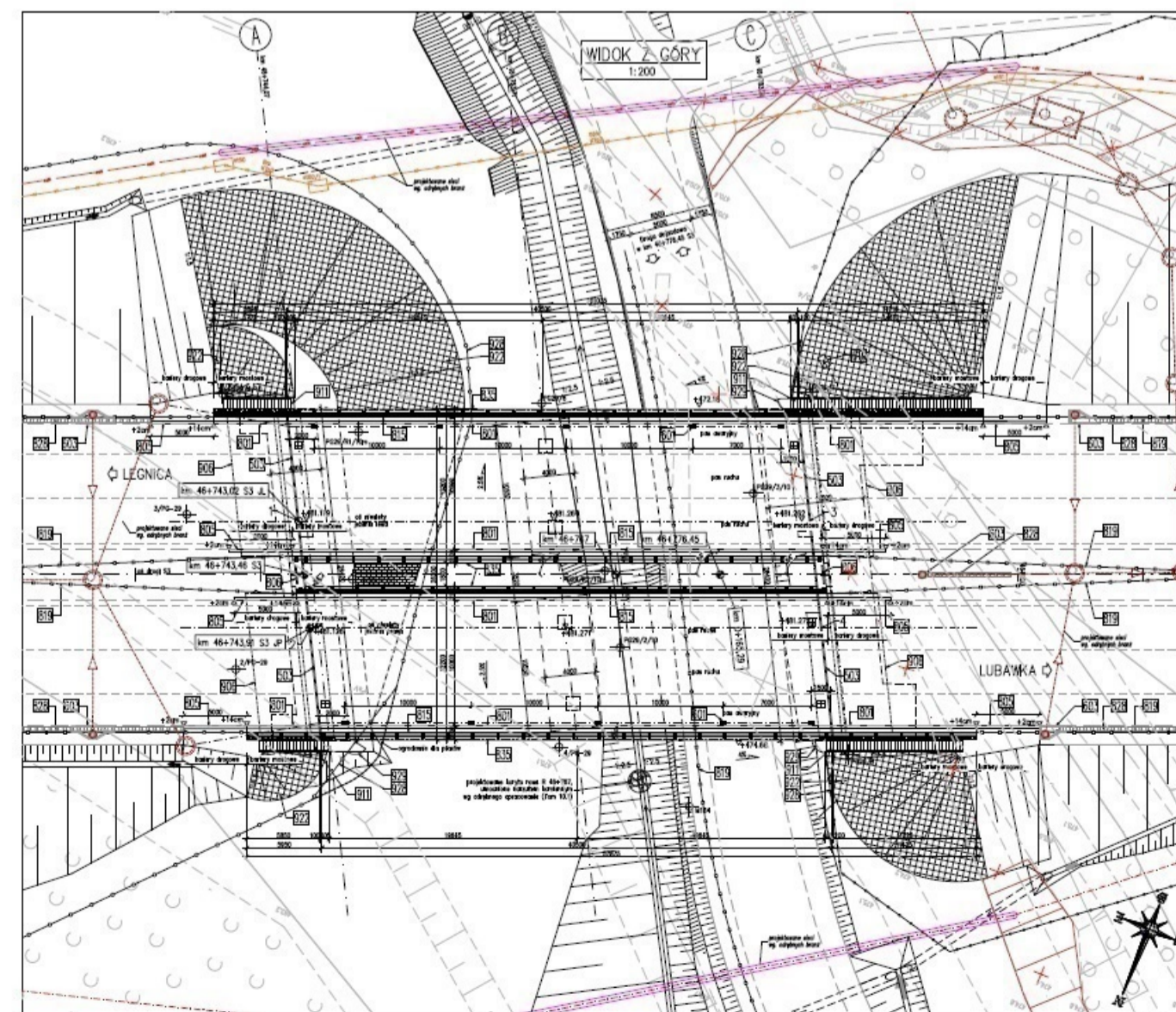
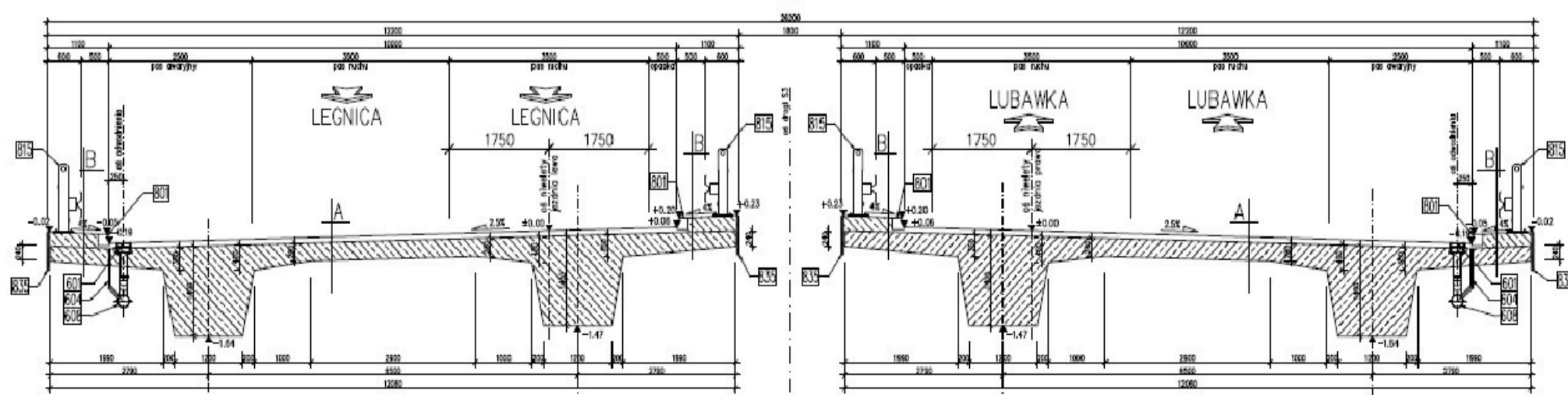

# WS-30

km 46+908.42

Legenda: **Stan na dzień 23.04.2023 r.**

- Roboty w trakcie wykonywania
- Roboty zakończone

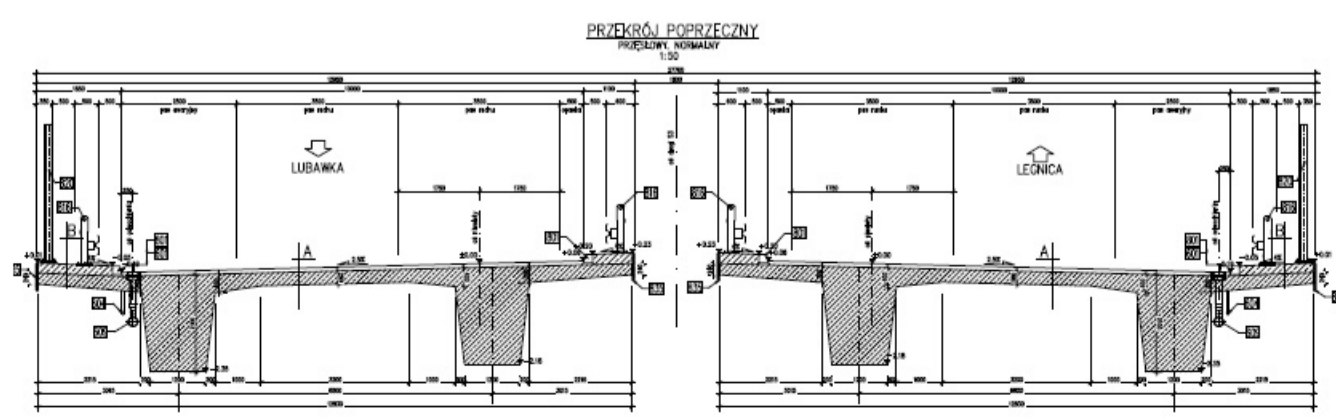
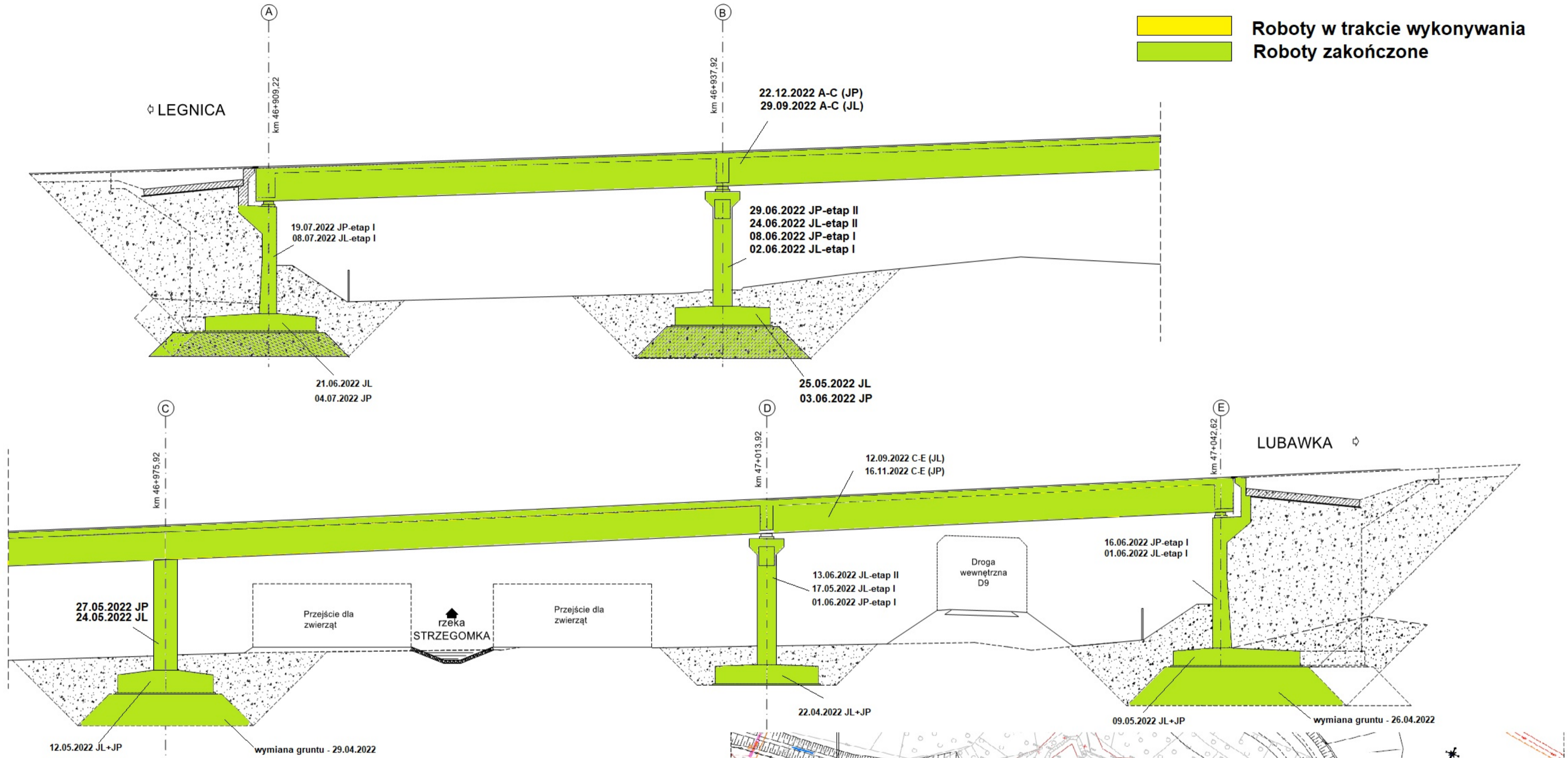

# WS-31 km 47+568,12

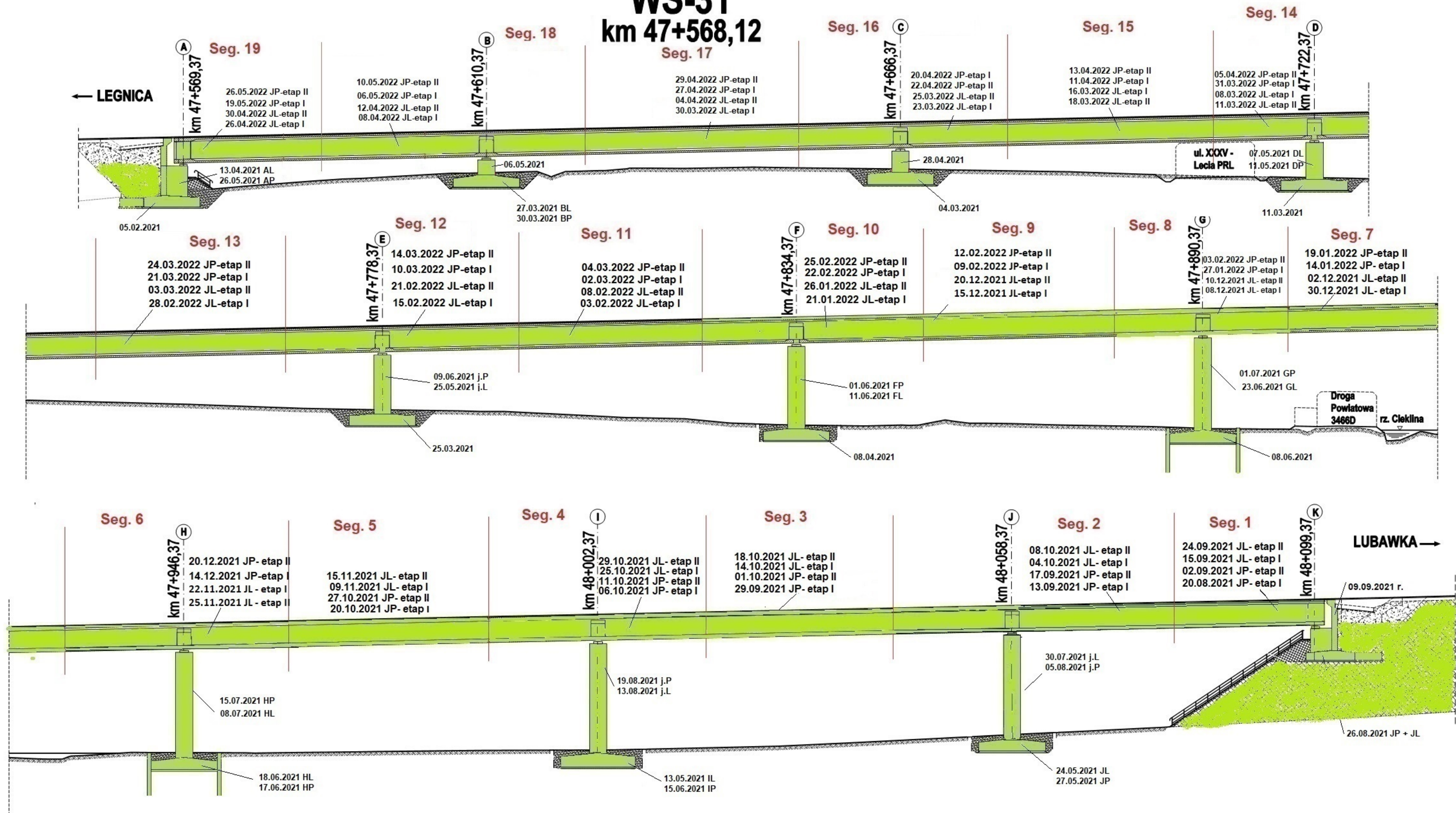

**Legenda: Stan na dzień 23.04.2023 r.**

- Roboty w trakcie
- Roboty zakończone

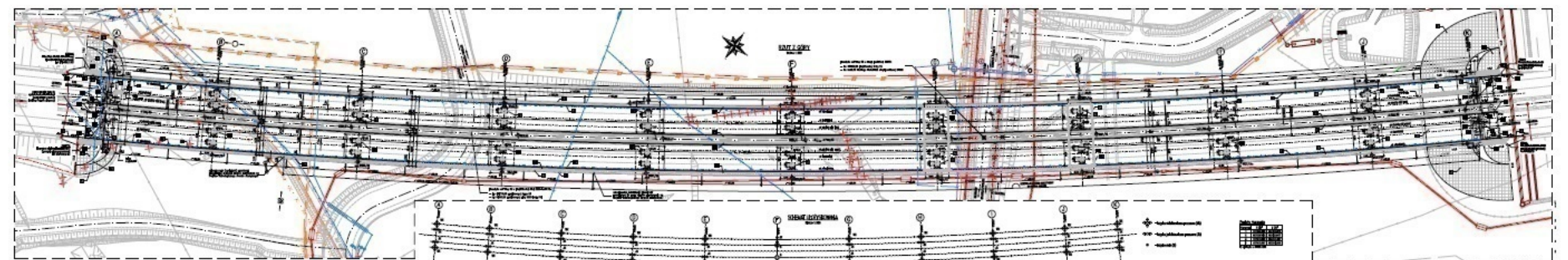
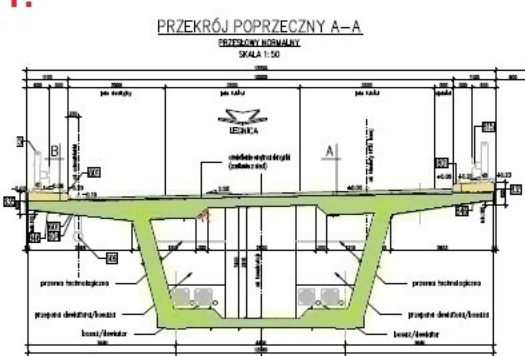

# TUNEL TS-32

## km 48+680,00 - 49+000,00

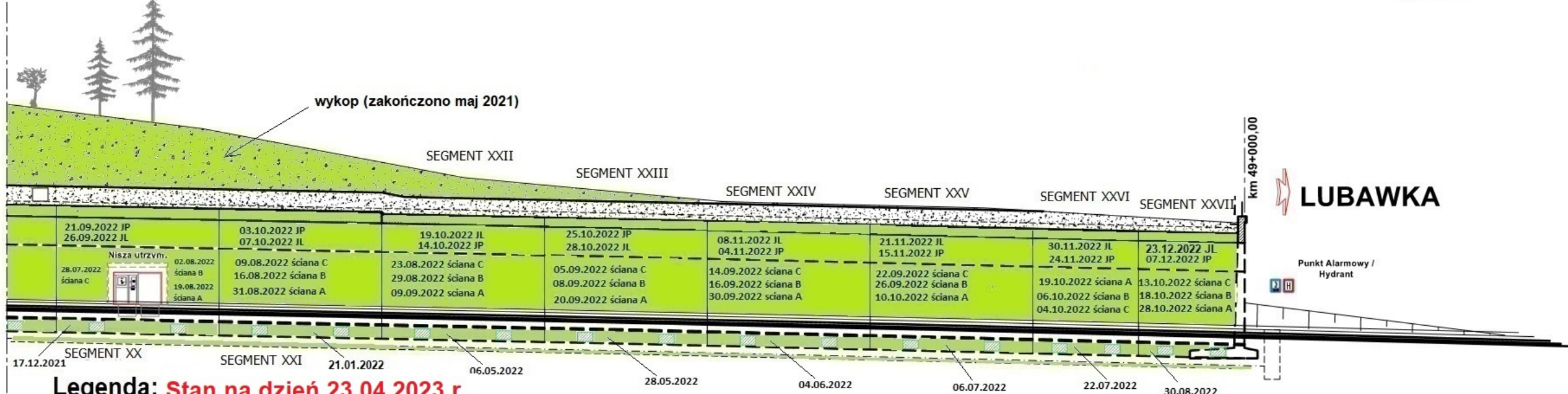
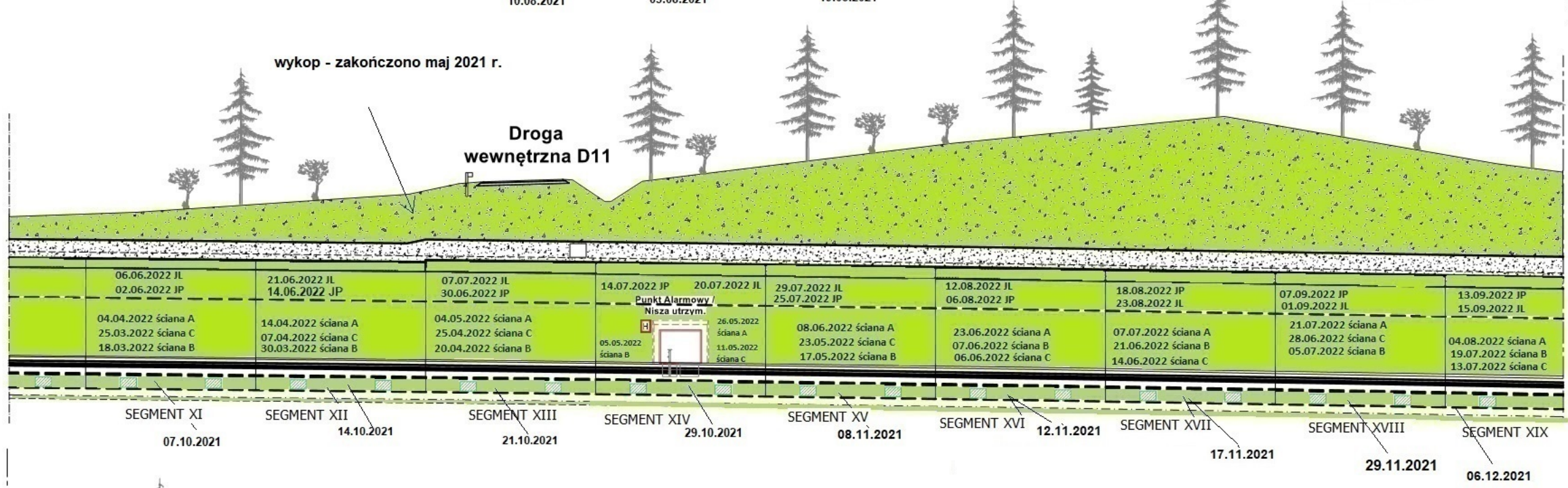
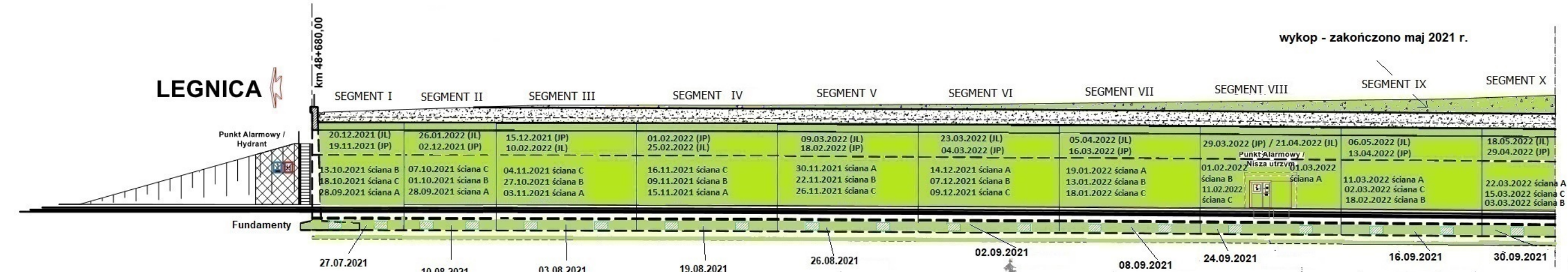

**Legenda: Stan na dzień 23.04.2023 r.**

- Roboty w trakcie wykonywania
- Roboty zakończone

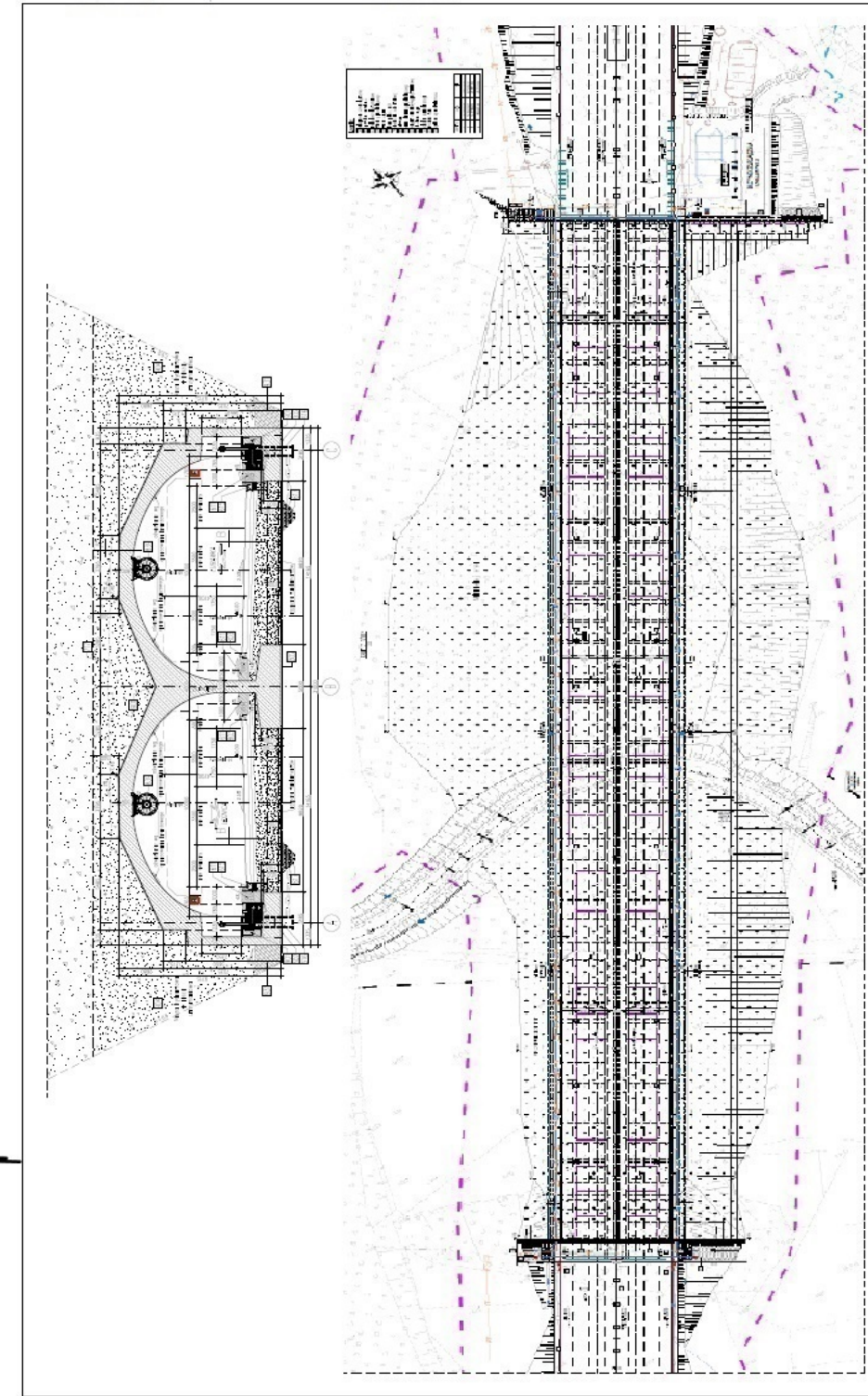



# PG 10.1

## km 50+097,00

← LEGNICA

LUBAWKA →

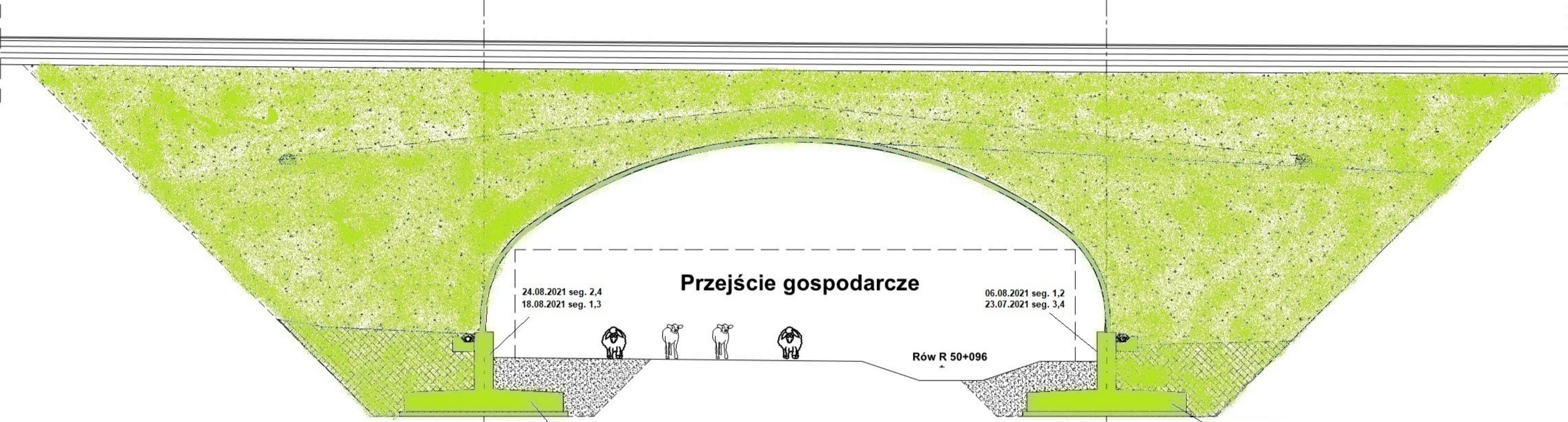

24.08.2021 seg. 2,4  
18.08.2021 seg. 1,3

06.08.2021 seg. 1,2  
23.07.2021 seg. 3,4

Rów R 50+096

**Przejście gospodarcze**

**Legenda: Stan na dzień 23.04.2023 r.**

- Roboty w trakcie wykonywania
- Roboty zakończone

05.07.2021 seg. 1,3  
24.06.2021 seg. 2,4

08.07.2021 seg. 1,3  
29.07.2021 seg. 2,4

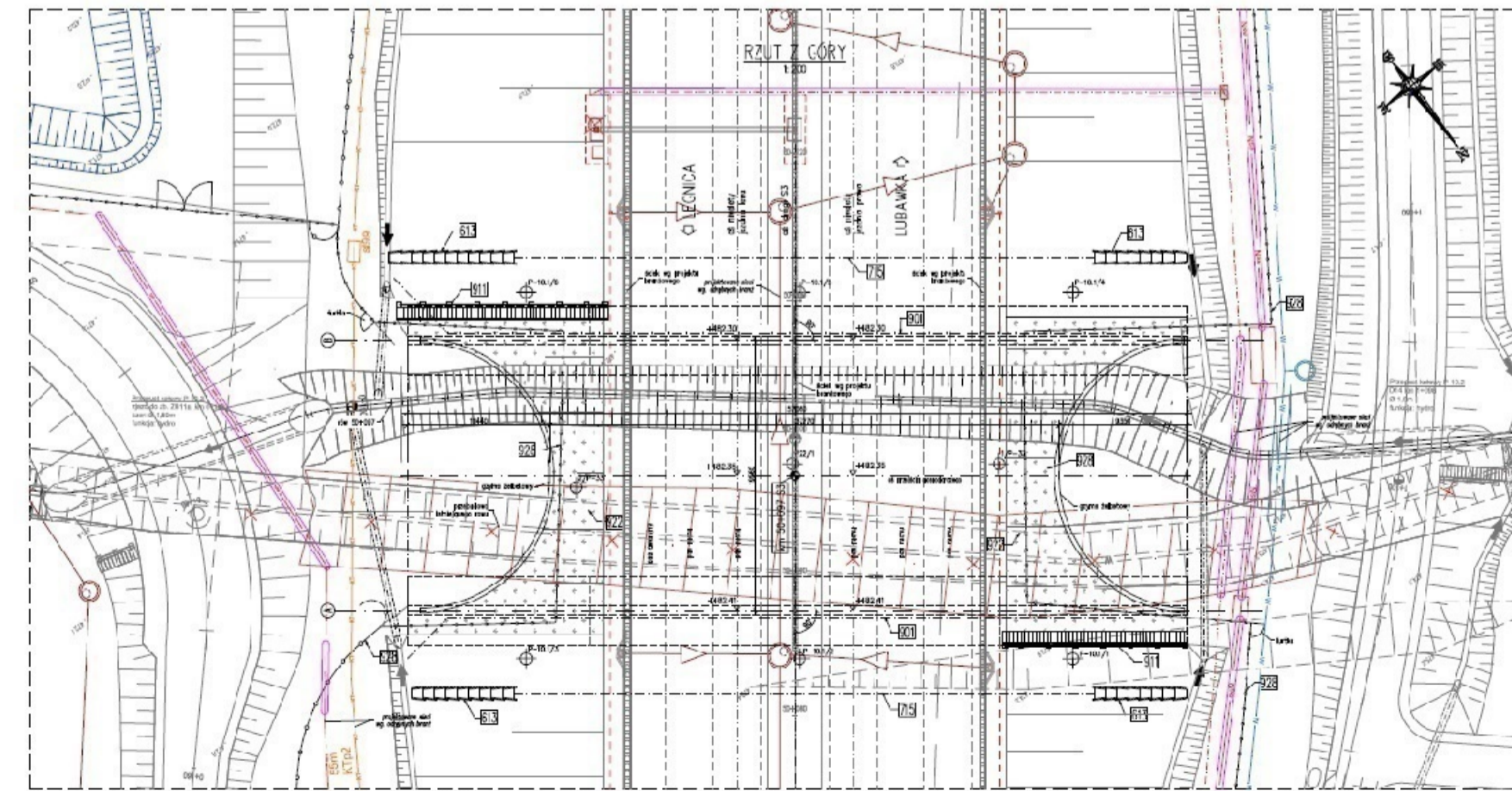
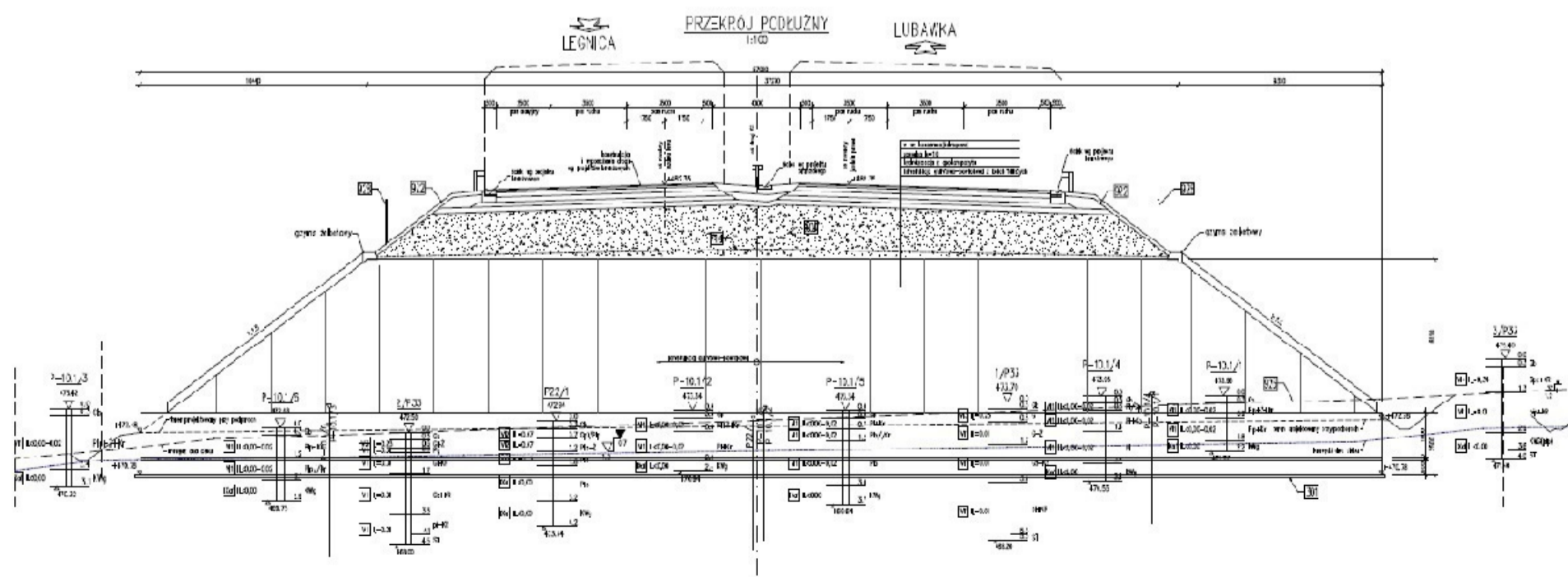

**WS-33**  
km 49+530,70

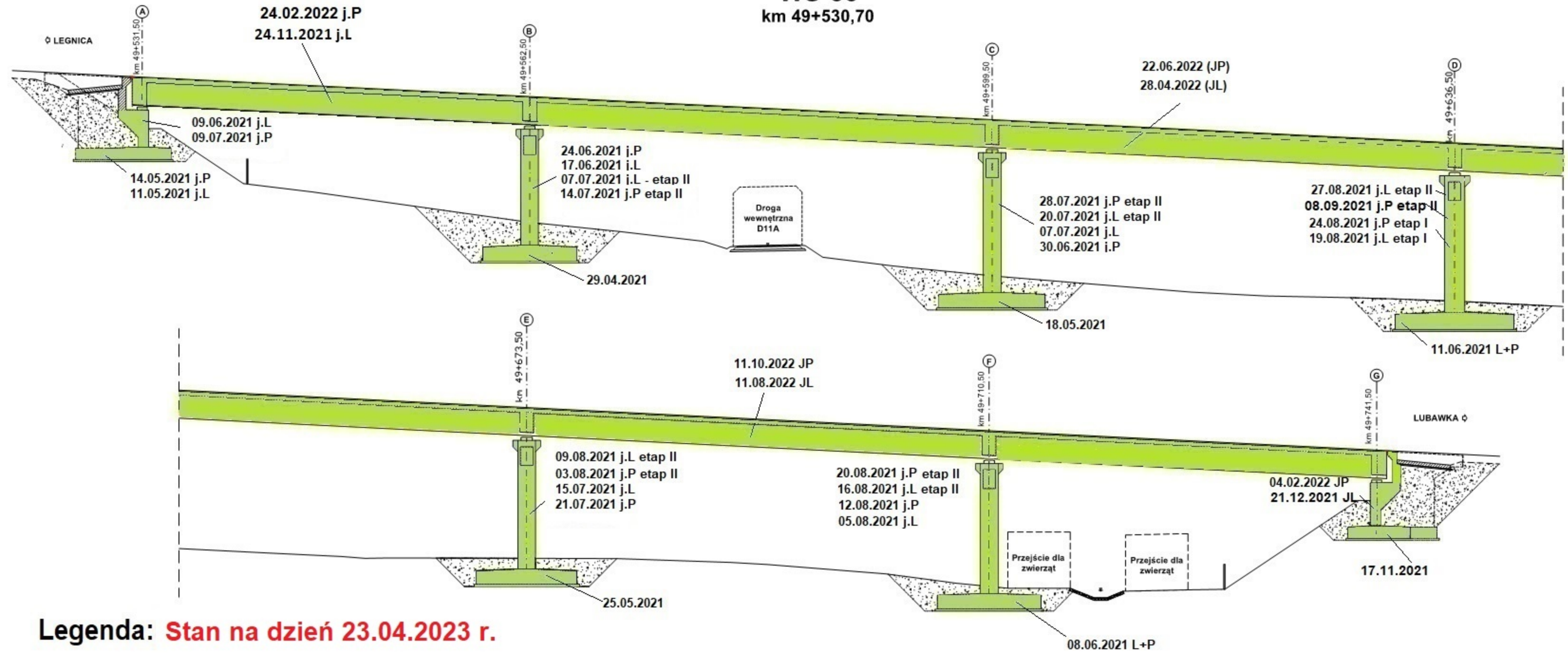

**Legenda: Stan na dzień 23.04.2023 r.**

- Roboty w trakcie wykonywania
- Roboty zakończone

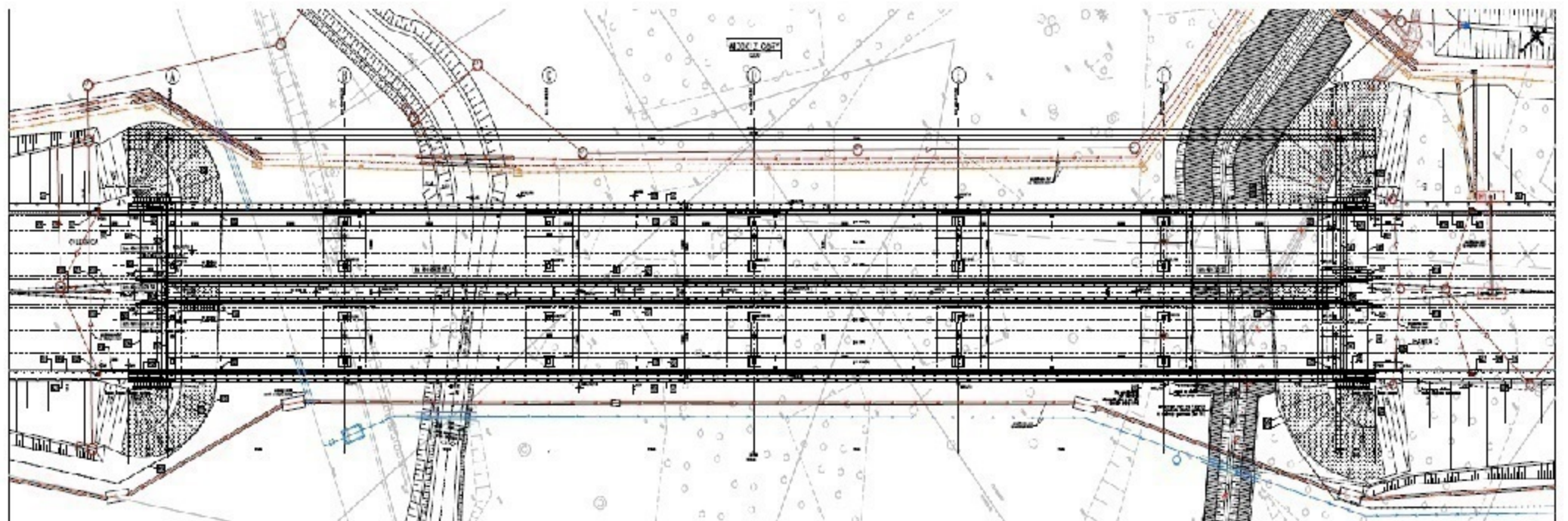
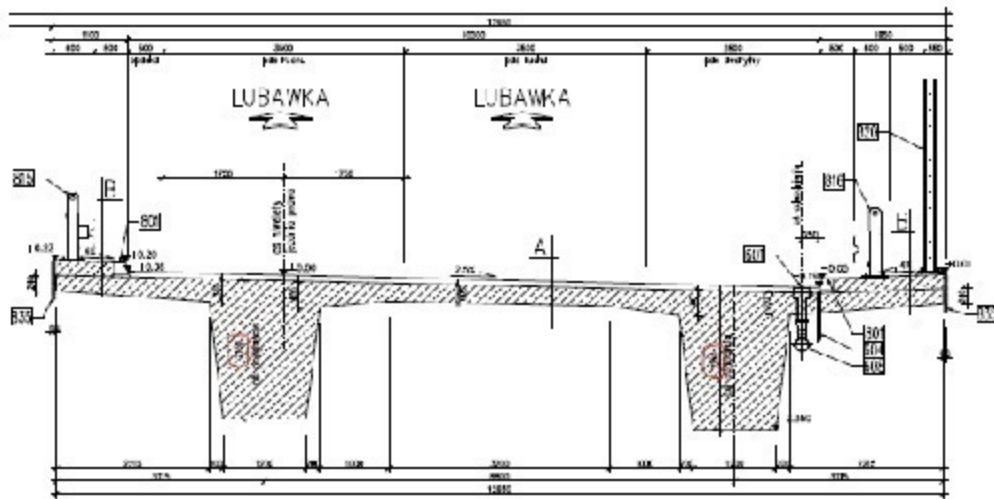

# WD-34

## km 50+661,15

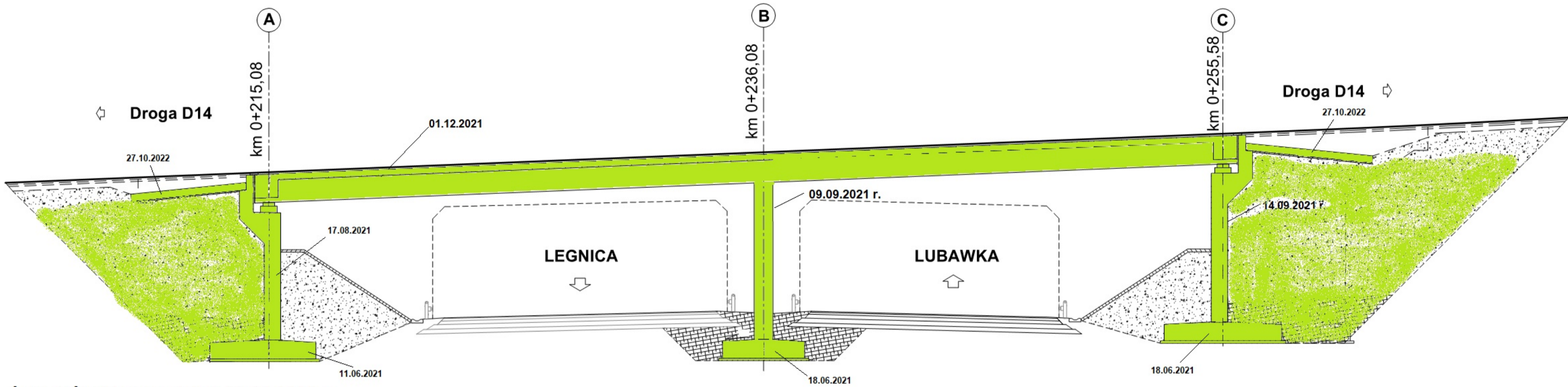

Legenda: **Stan na dzień 23.04.2023 r.**

- Roboty w trakcie wykonywania
- Roboty zakończone

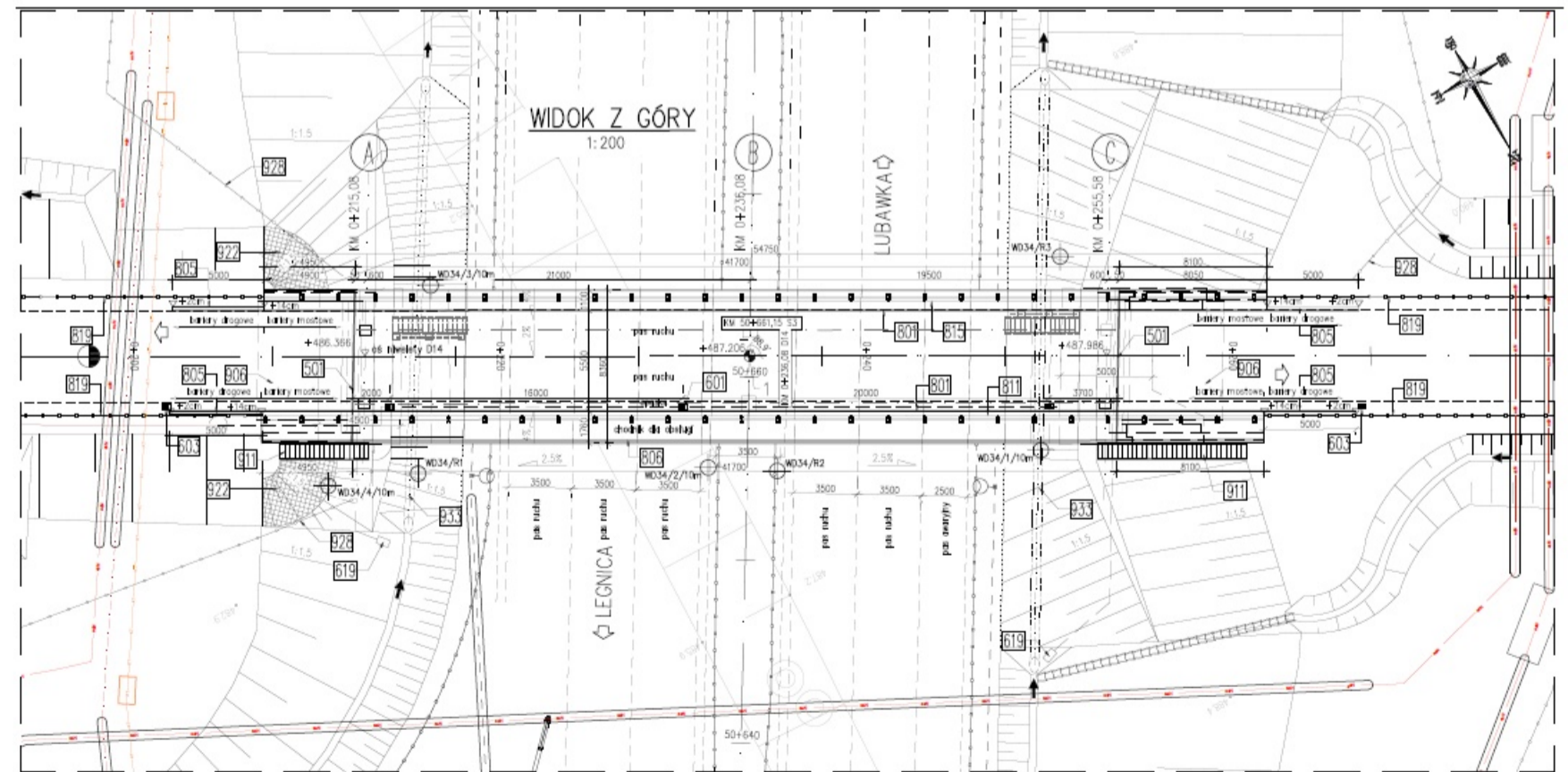

# PG 11.1

## km 51+249,00



Legenda: **Stan na dzień 23.04.2023 r.**

- Roboty w trakcie wykonywania
- Roboty zakończone

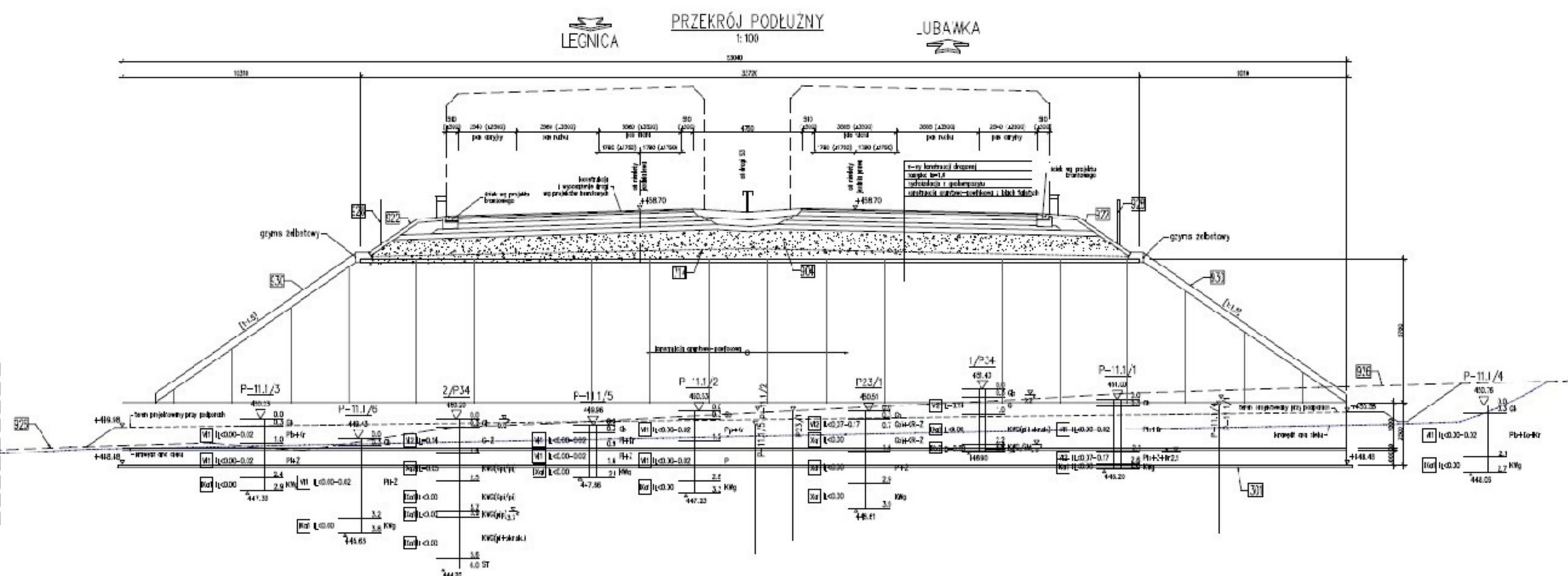

# WS-35

## km 51+508,81

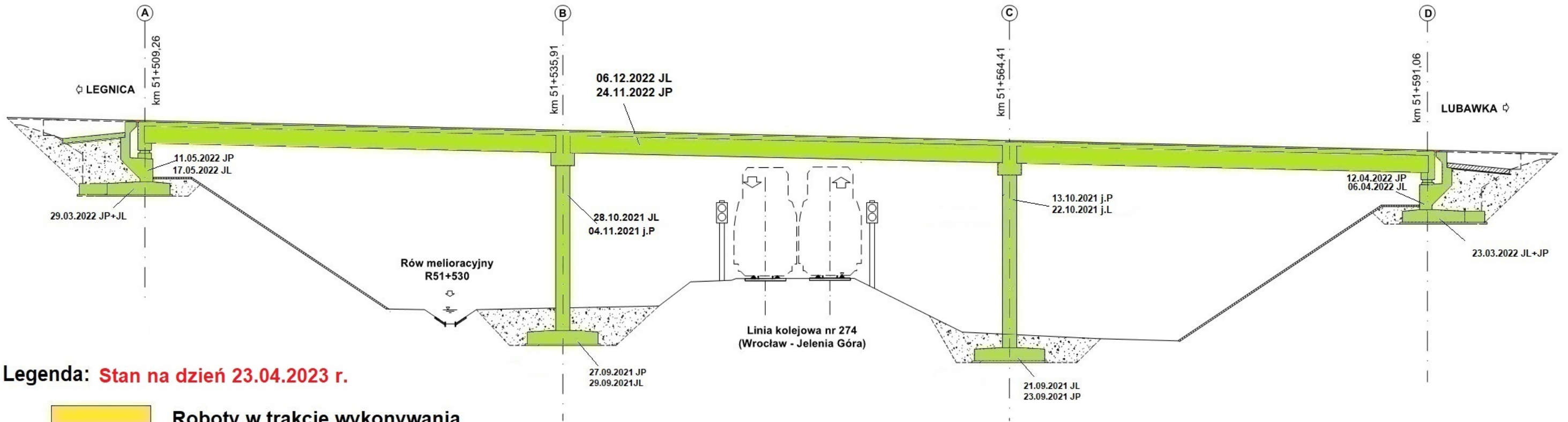

Legenda: Stan na dzień 23.04.2023 r.

- Roboty w trakcie wykonywania
- Roboty zakończone

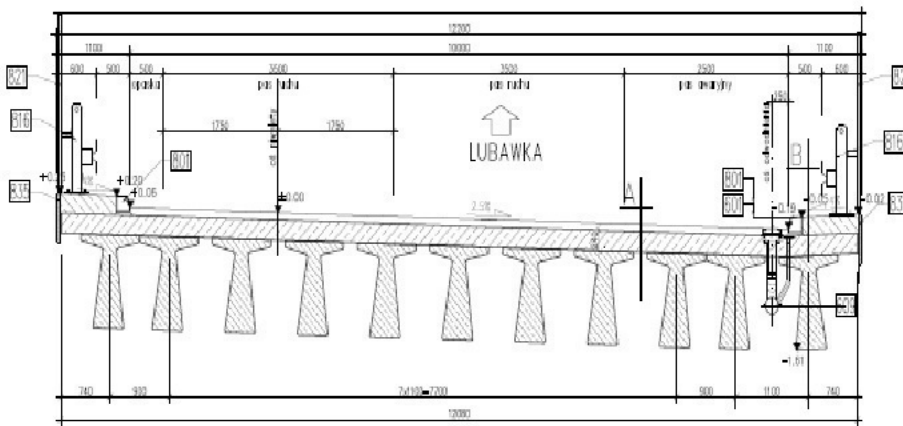

# WS-36

## km 51+780,95

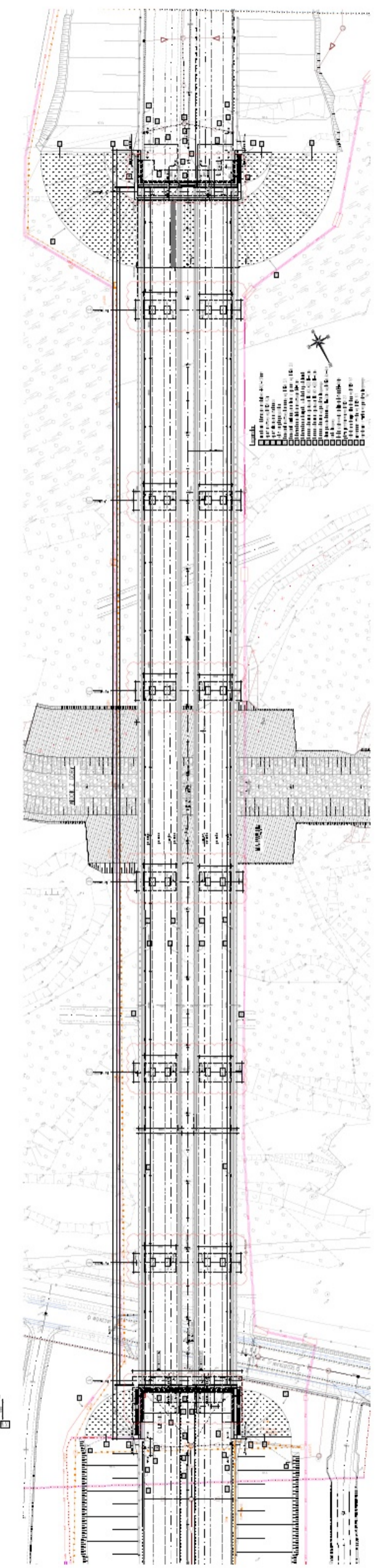
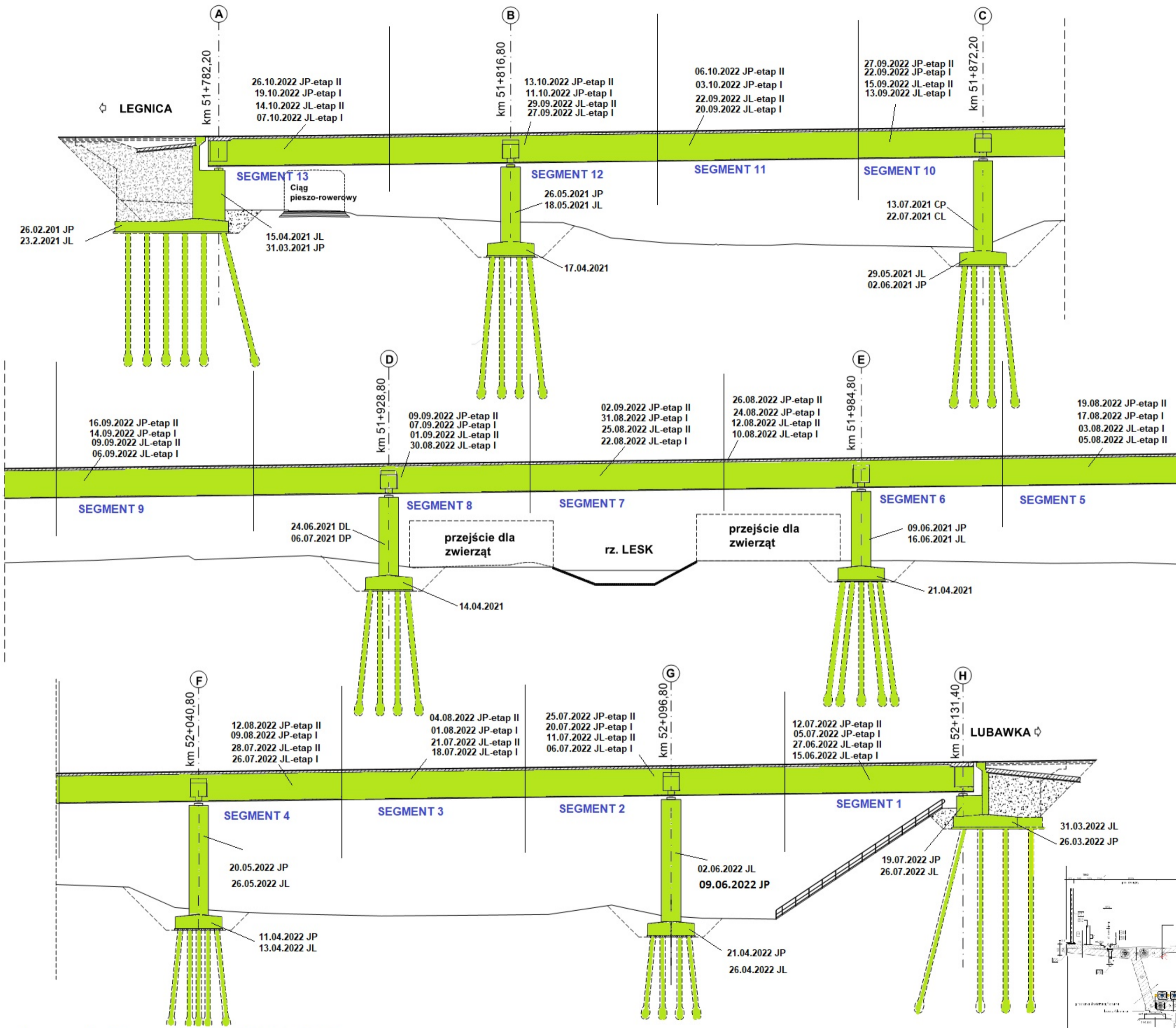

Legenda: Stan na dzień 23.04.2023 r.

- Roboty w trakcie wykonywania
- Roboty zakończone

# WS-37

## km 52+994,25

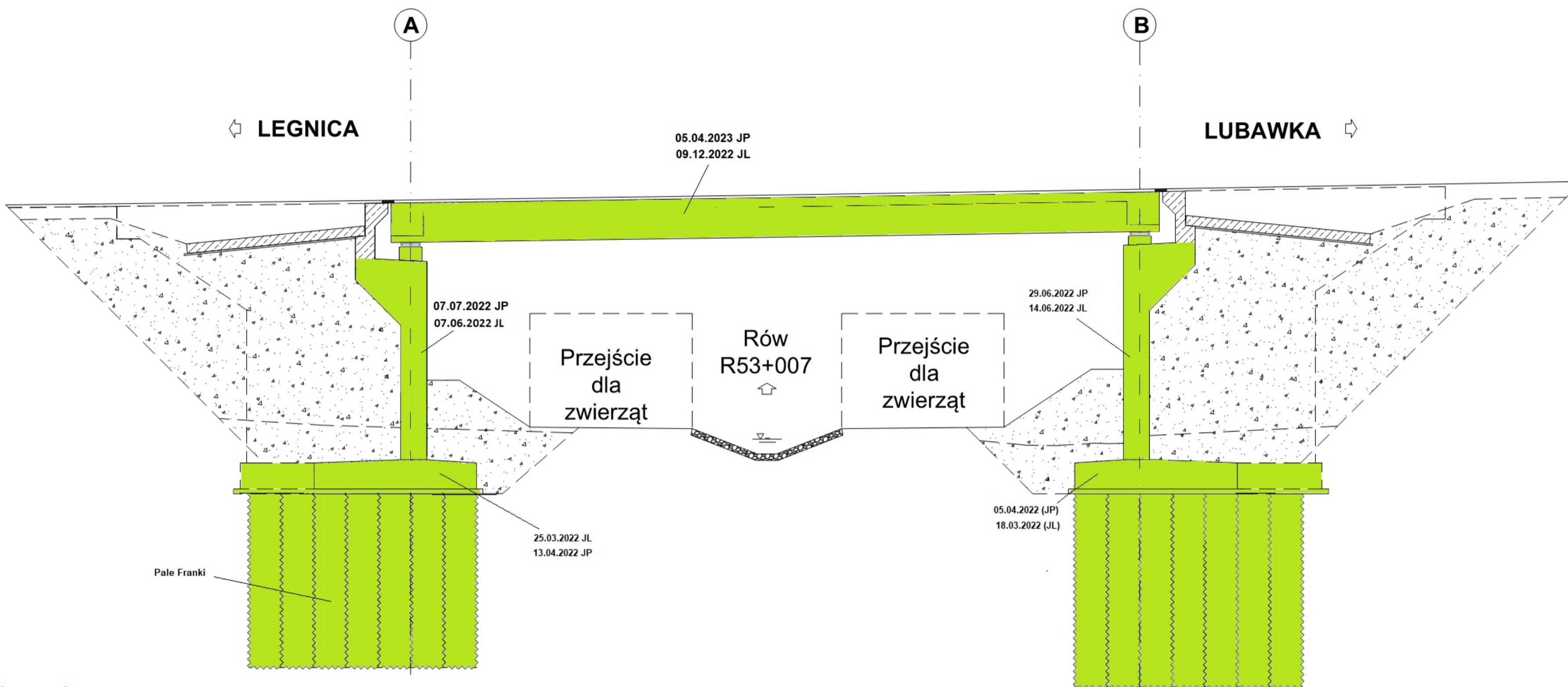

Legenda: Stan na dzień 23.04.2023 r.

- Roboty w trakcie wykonywania
- Roboty zakończone

PRZEKRÓJ POPRZECZNY  
PRZEŚLONY, NORMALNY  
1:50

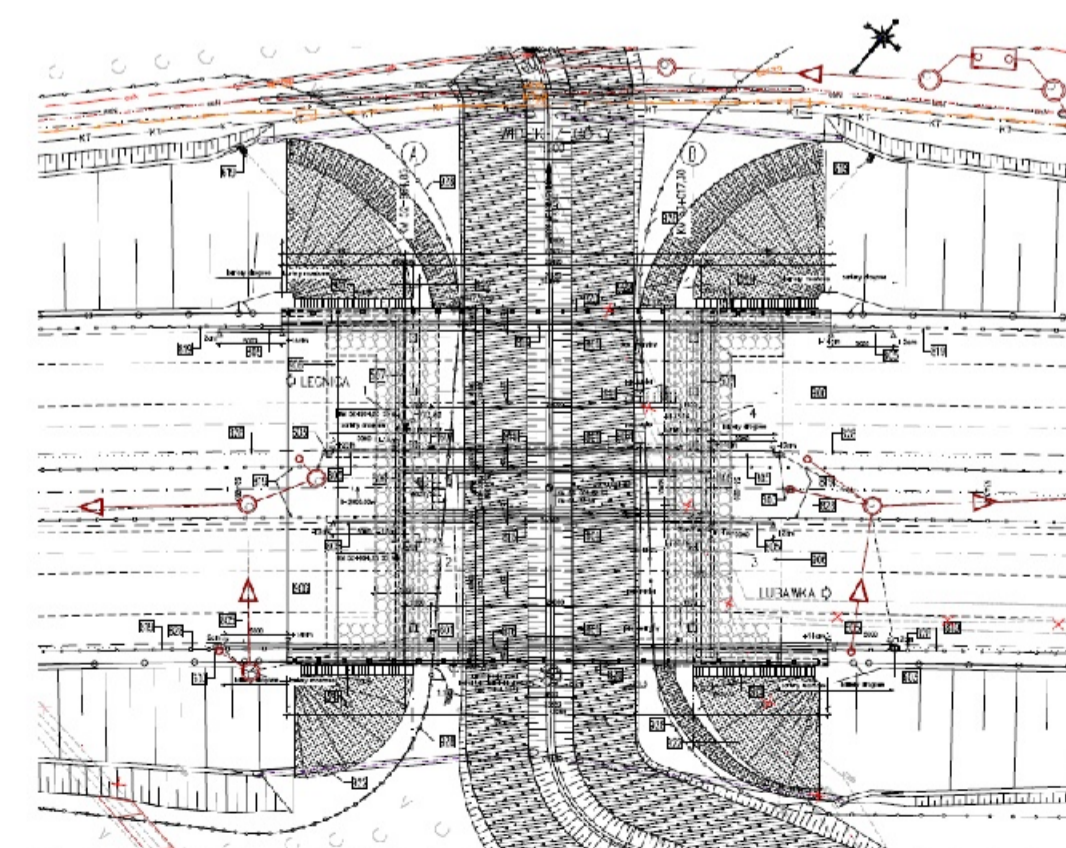
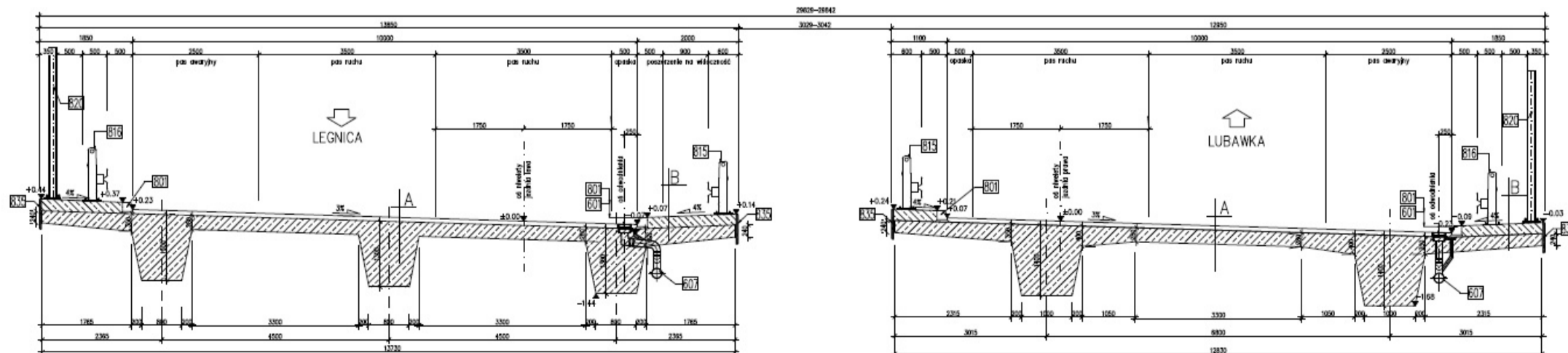

# WD-38

## km 53+798,79

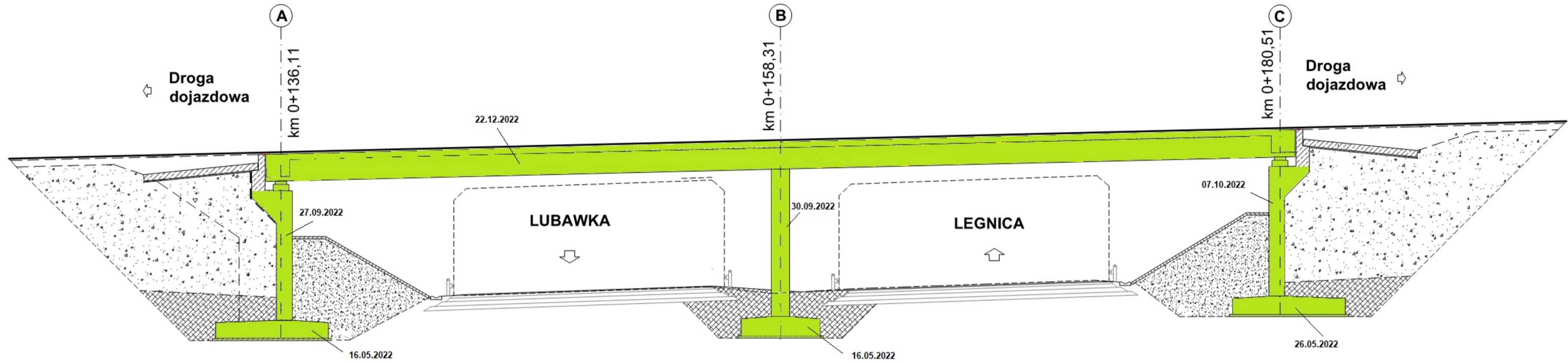

**Legenda: Stan na dzień 23.04.2023 r.**

- Roboty w trakcie wykonywania
- Roboty zakończone

**PRZEKRÓJ POPRZECZNY**  
PRZESŁONY NORMATYWNY  
1:30

