

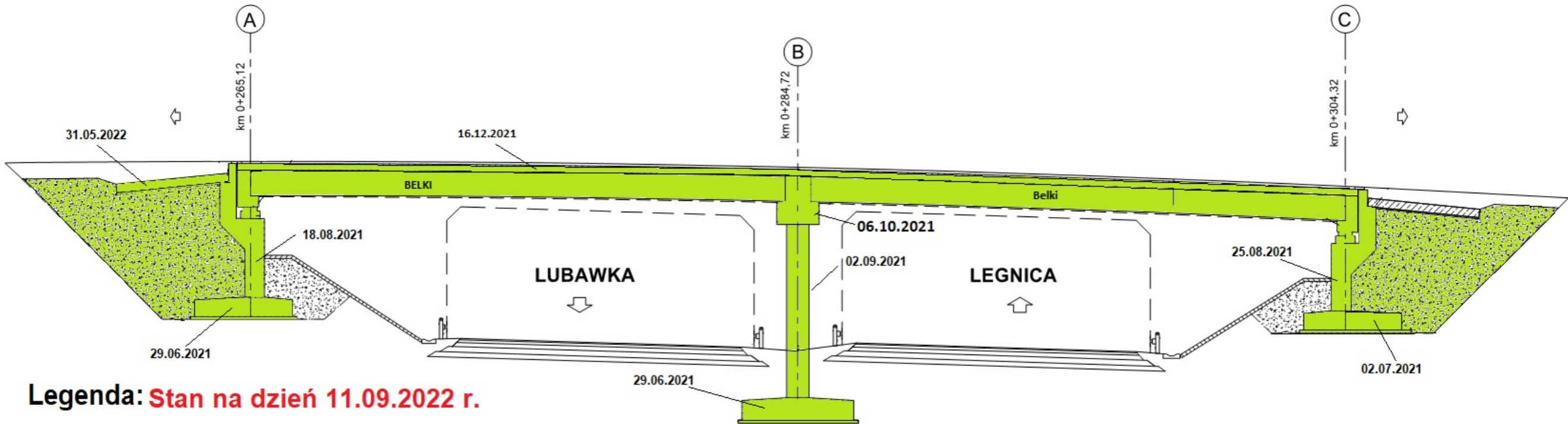

# WD-22

## km 38+491,21



Legenda: Stan na dzień 11.09.2022 r.

-  Roboty w trakcie wykonywania
-  Roboty zakończone

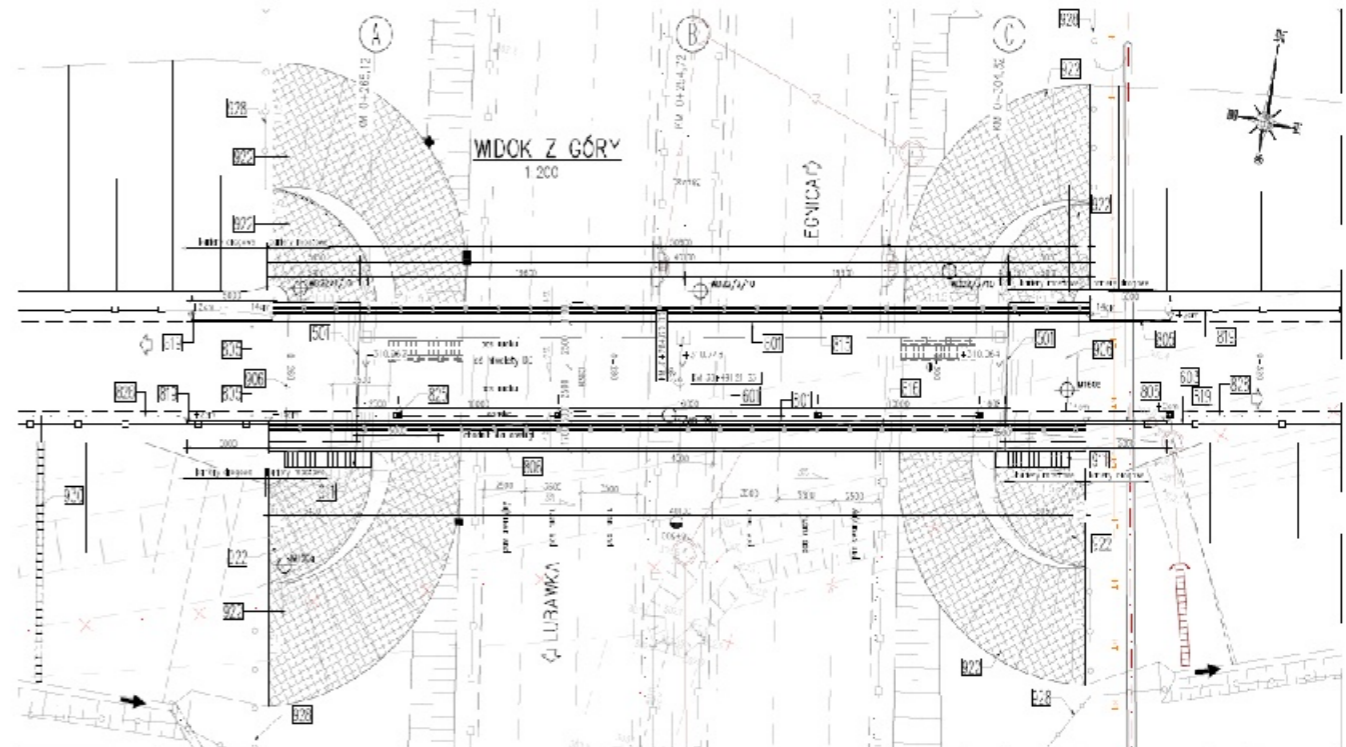



# WS-24

## km 41+431,41

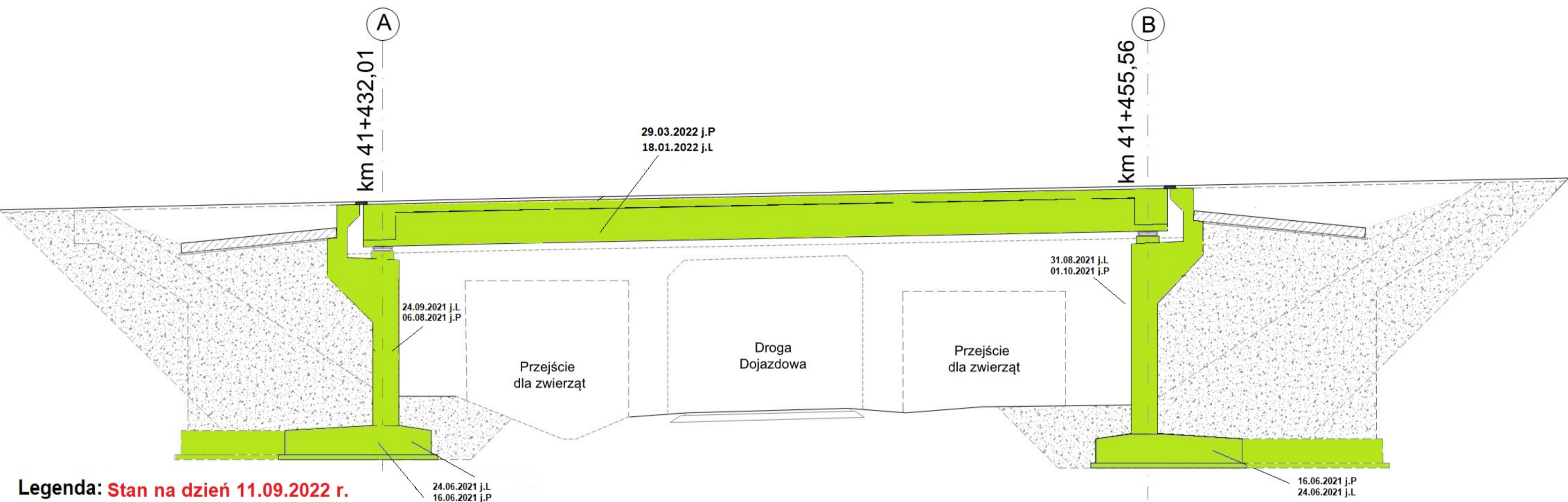

Legenda: Stan na dzień 11.09.2022 r.

- Roboty w trakcie wykonywania
- Roboty zakończone

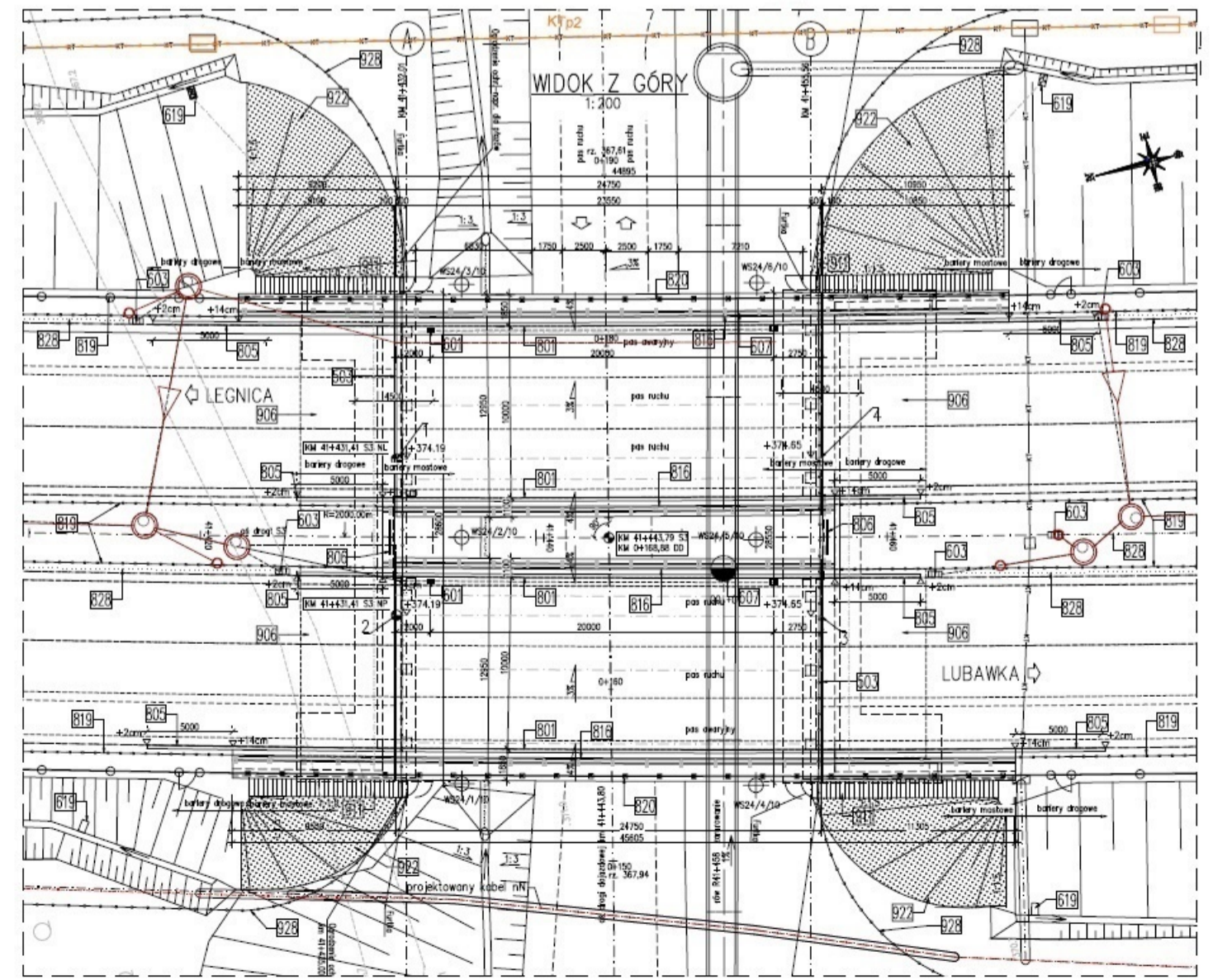
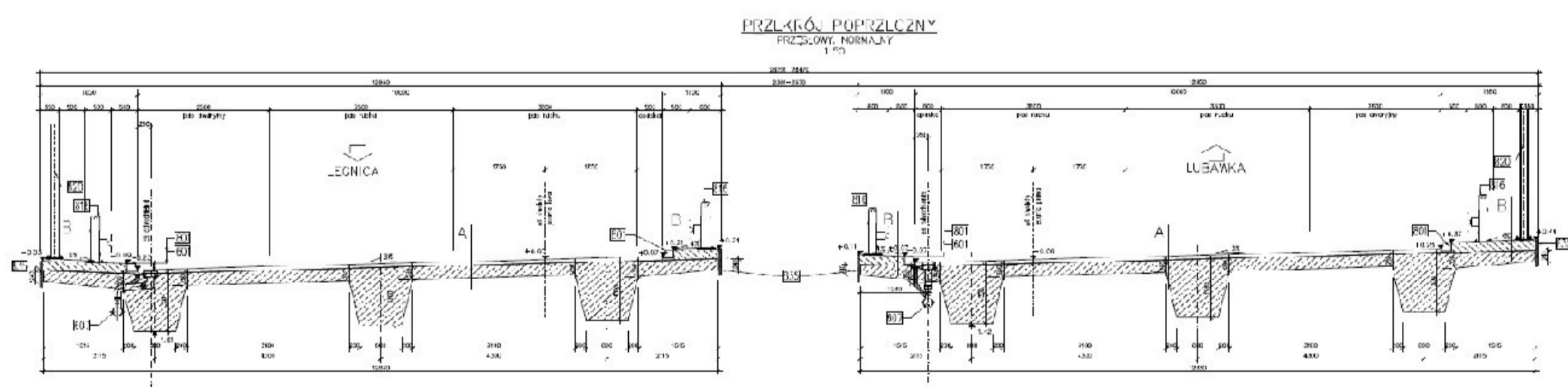



# MS-25

km 41+996,65

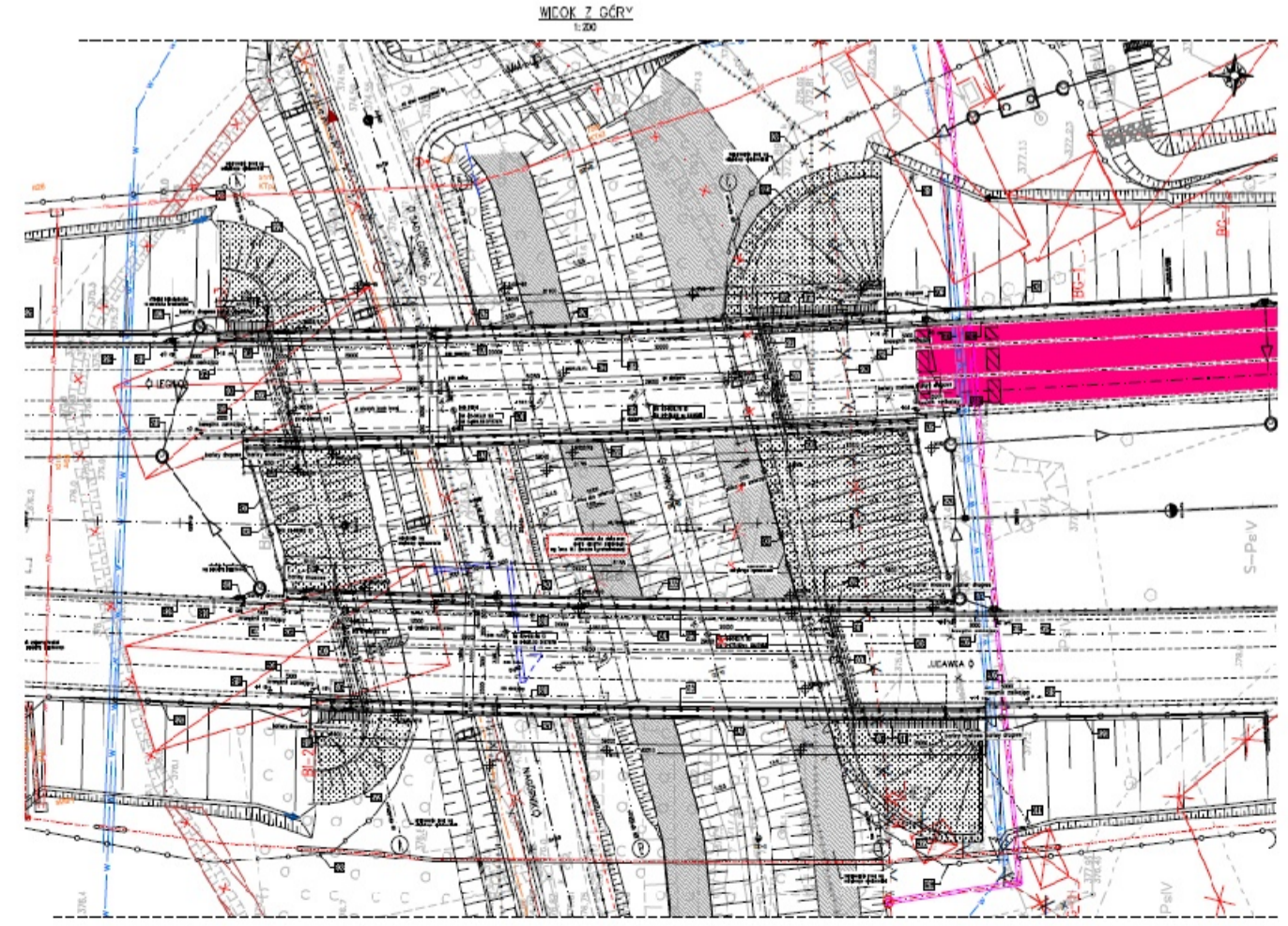
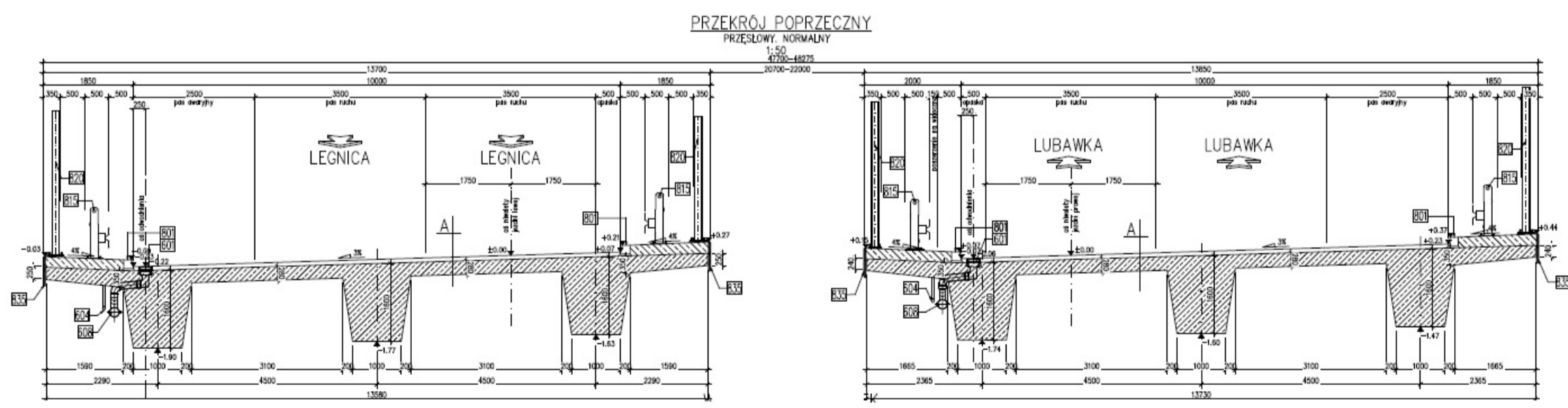
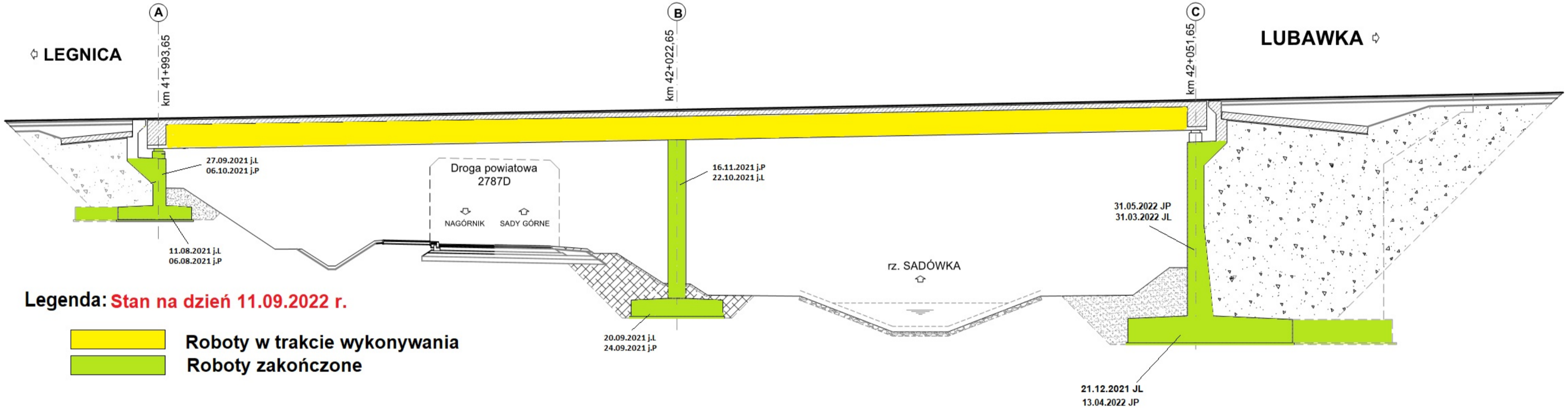



# WD-27

km 44+702,77

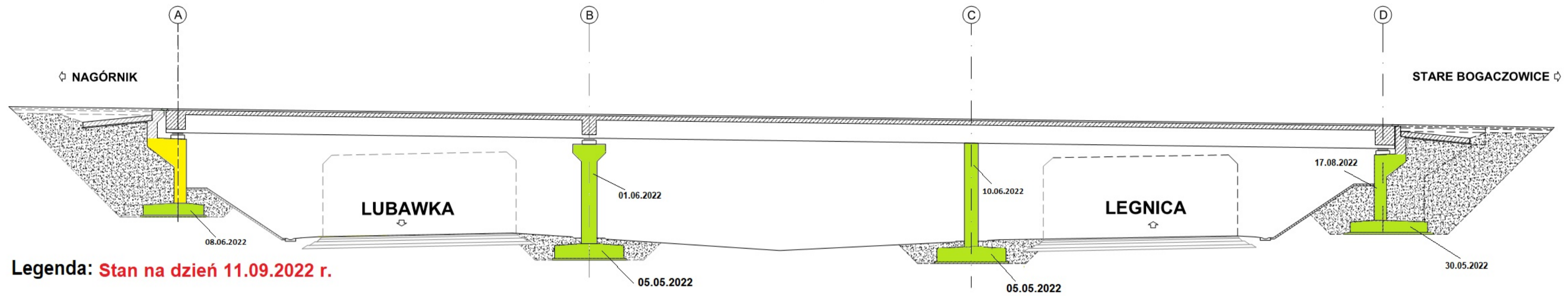

Legenda: Stan na dzień 11.09.2022 r.

- Roboty w trakcie wykonywania
- Roboty zakończone

PRZEKRÓJ POPRZECZNY  
Z WIDOKIEM NA FILAR  
1:50

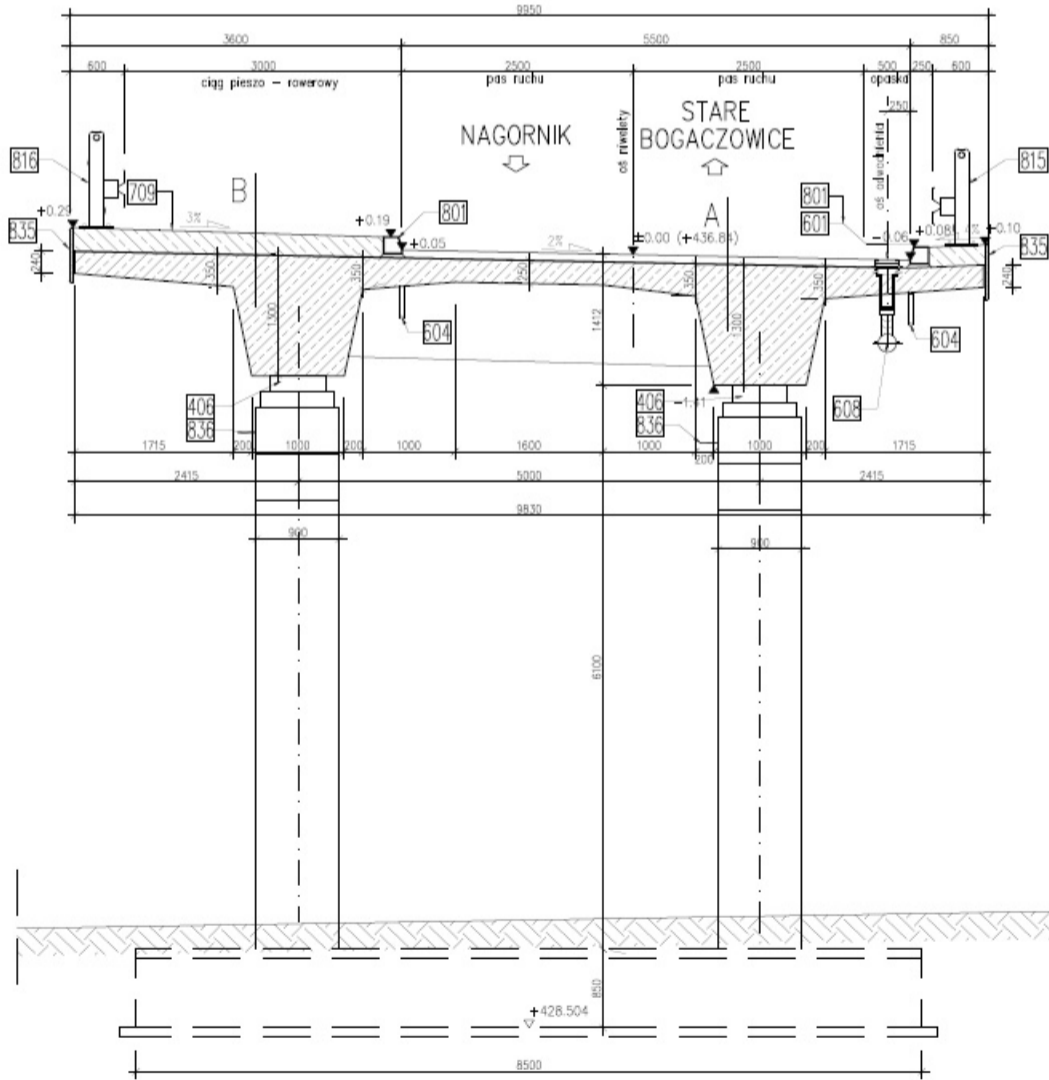

WIDOK Z GÓRY  
1:200

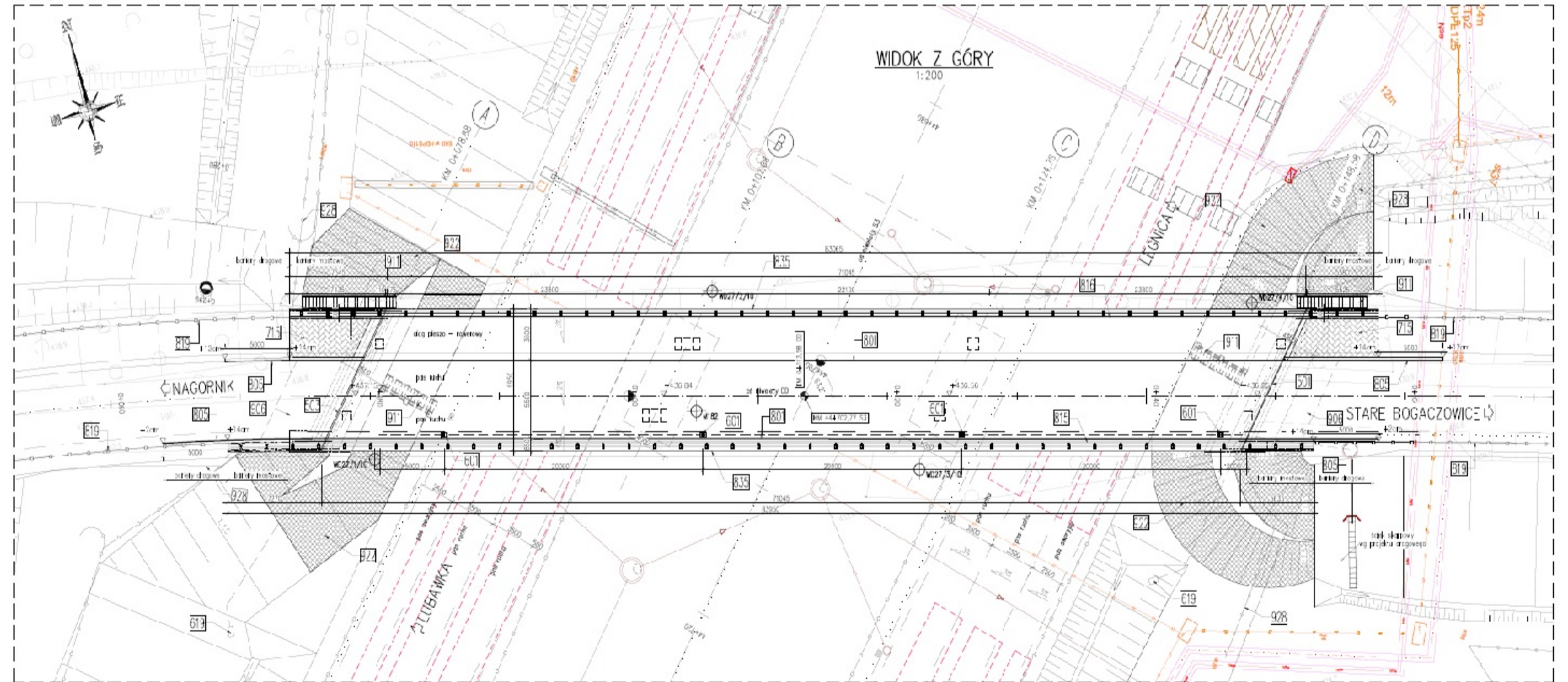



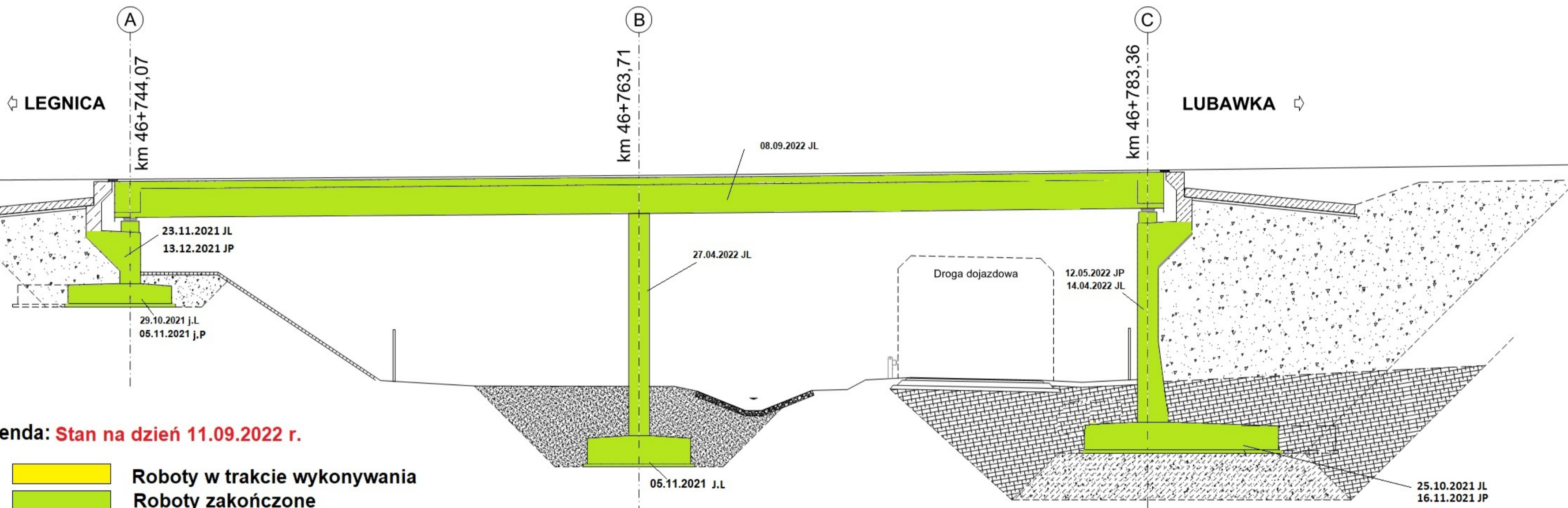

# PG-29

km 46+743,46



Legenda: Stan na dzień 11.09.2022 r.

-  Roboty w trakcie wykonywania
-  Roboty zakończone

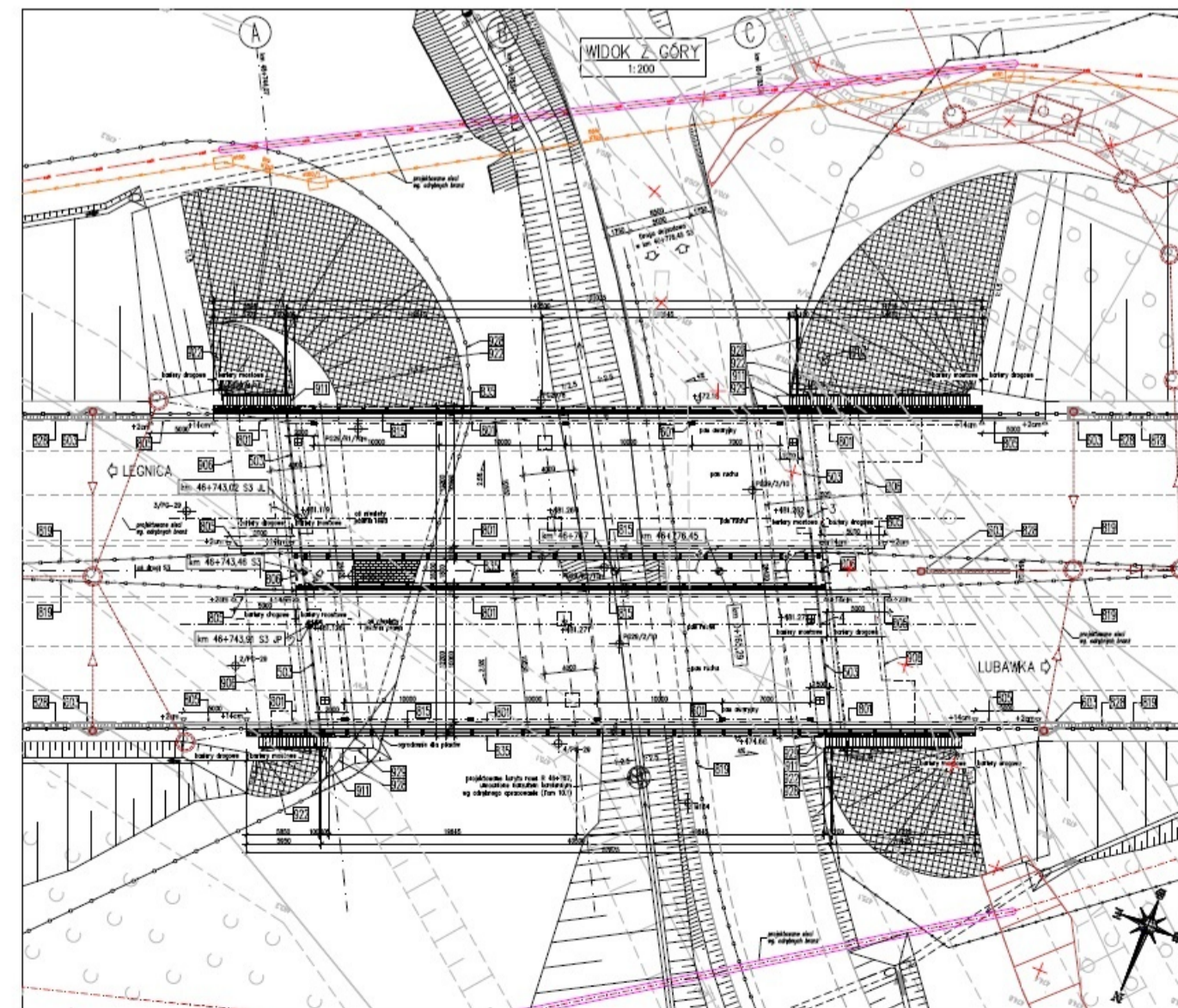
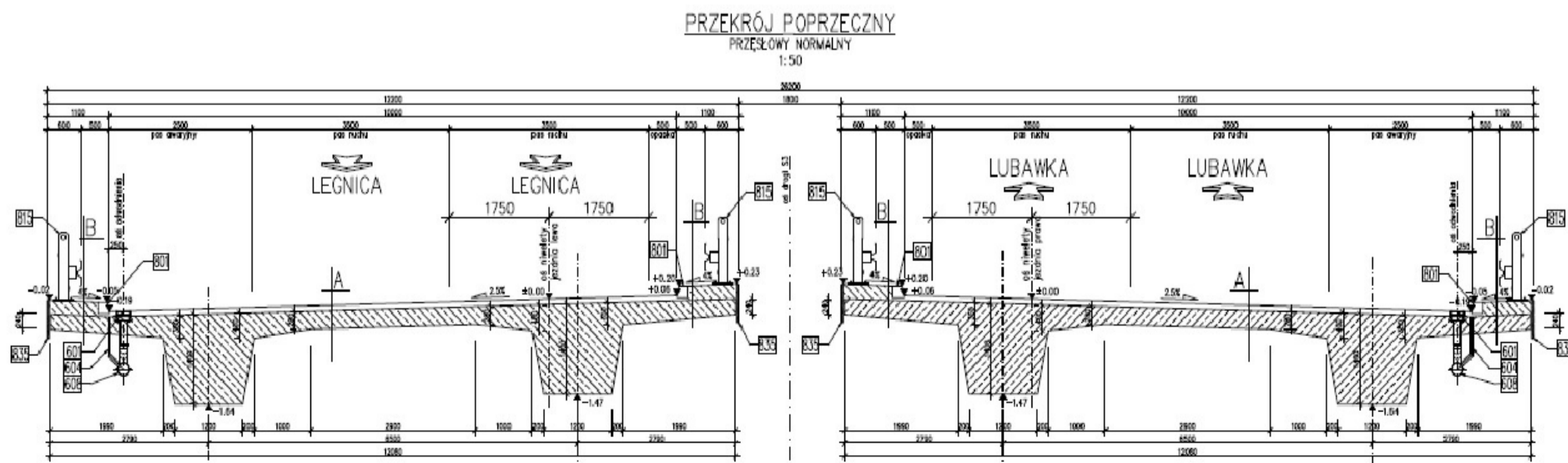



# WS-30

km 46+908.42

Legenda: **Stan na dzień 11.09.2022 r.**

- Roboty w trakcie wykonywania
- Roboty zakończone

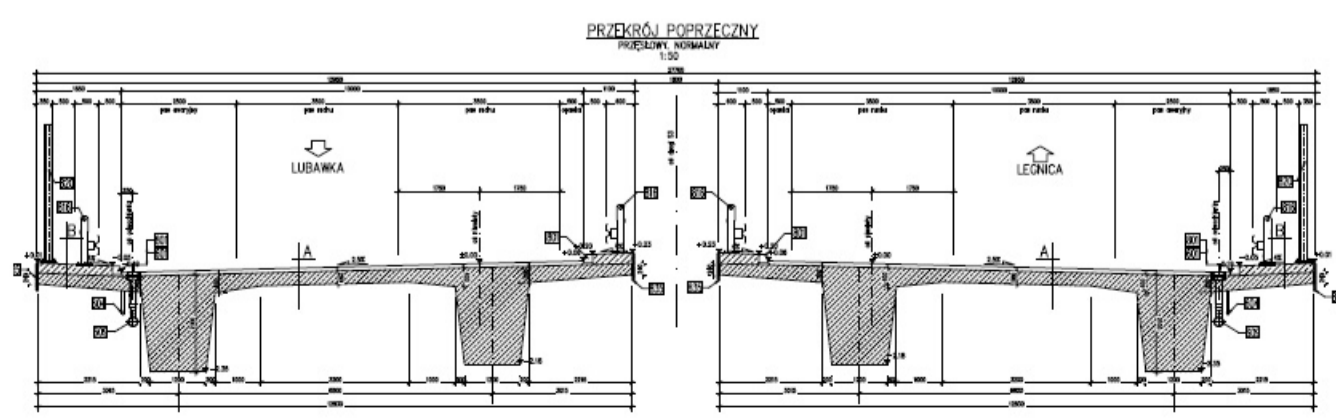
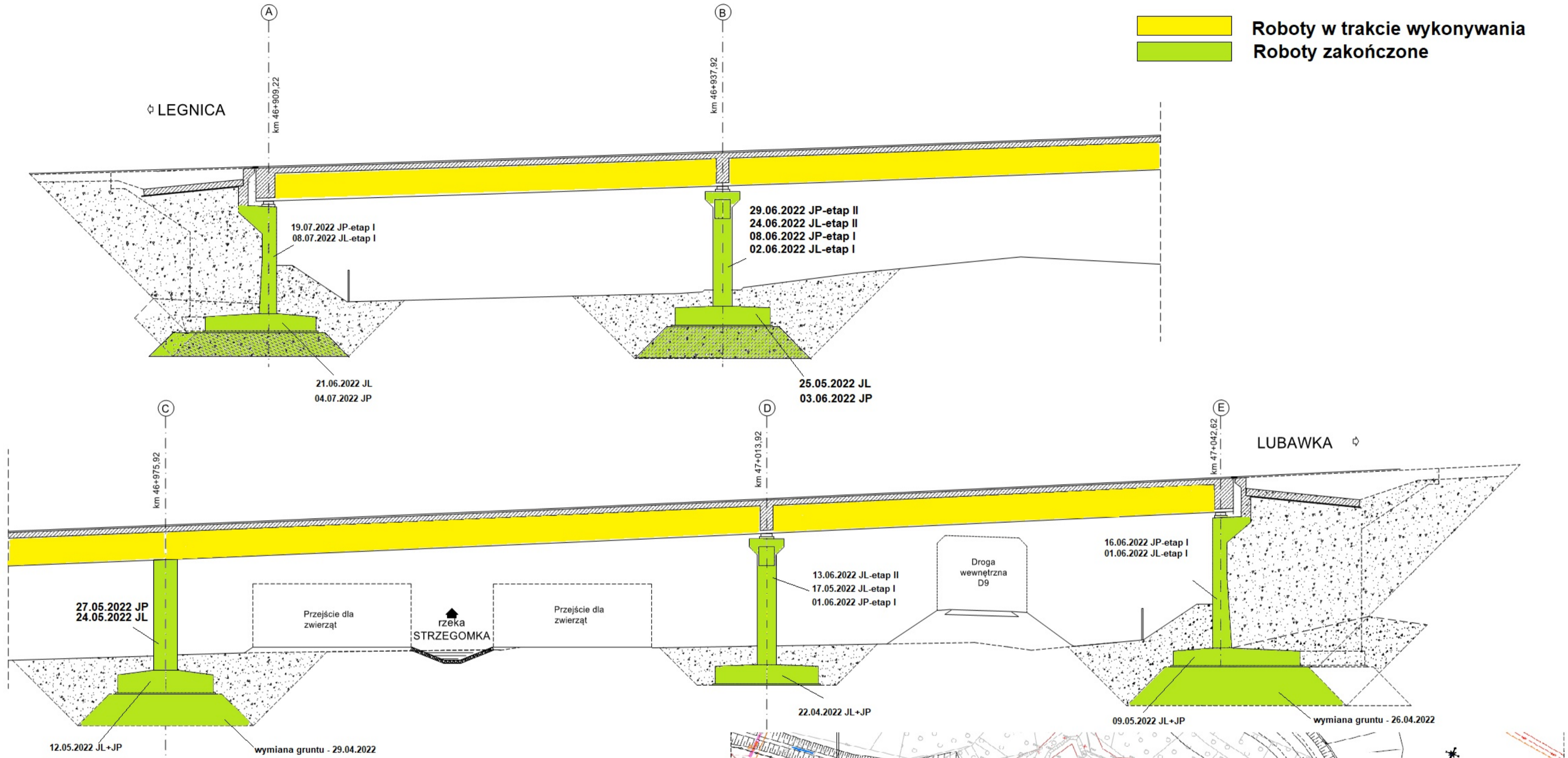



# WS-31 km 47+568,12

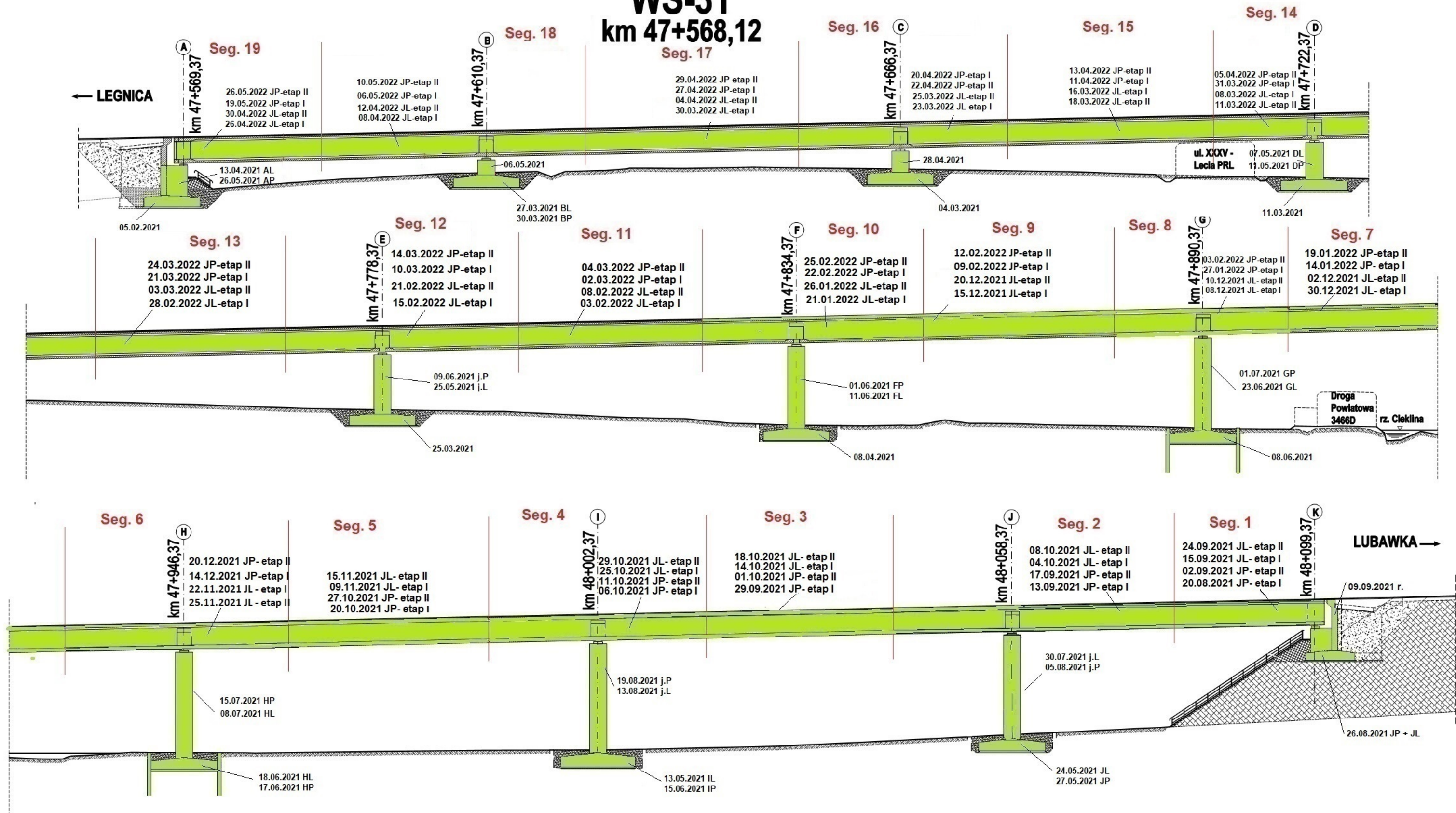

Legenda: Stan na dzień 11.09.2022 r.

- Roboty w trakcie
- Roboty zakończone

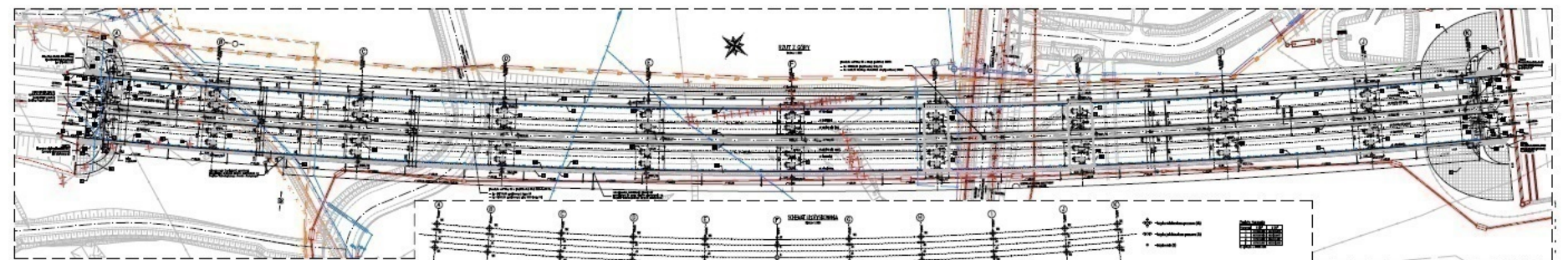
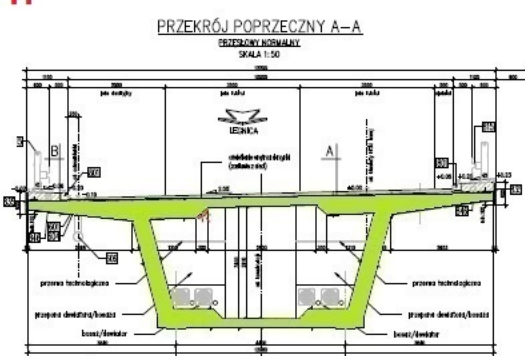







# PG 10.1

## km 50+097,00

← LEGNICA

LUBAWKA →

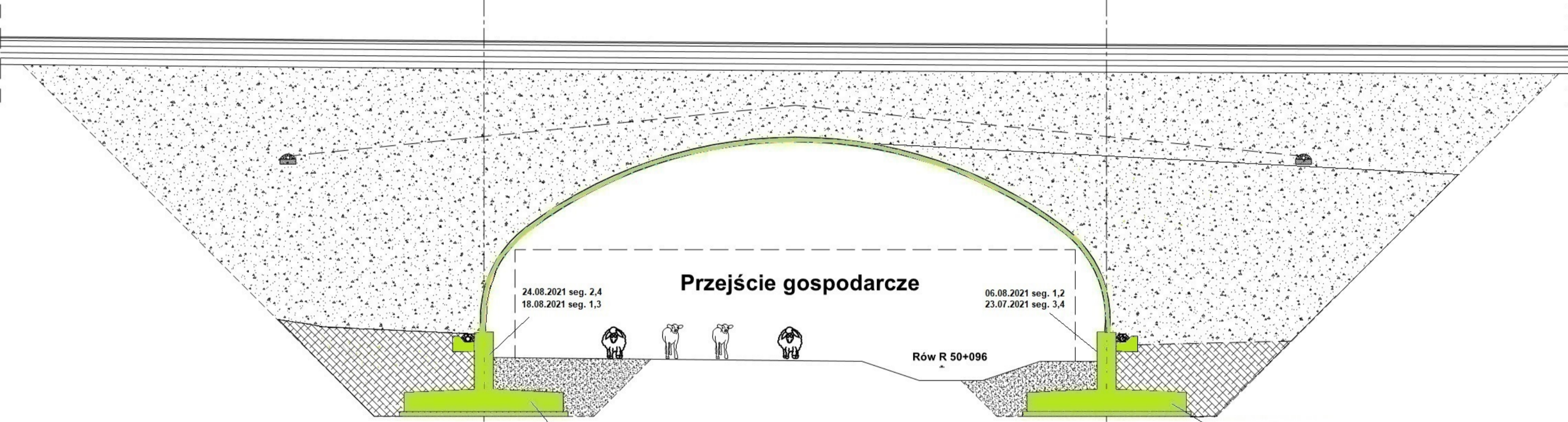

Legenda: Stan na dzień 11.09.2022 r.

- Roboty w trakcie wykonywania
- Roboty zakończone

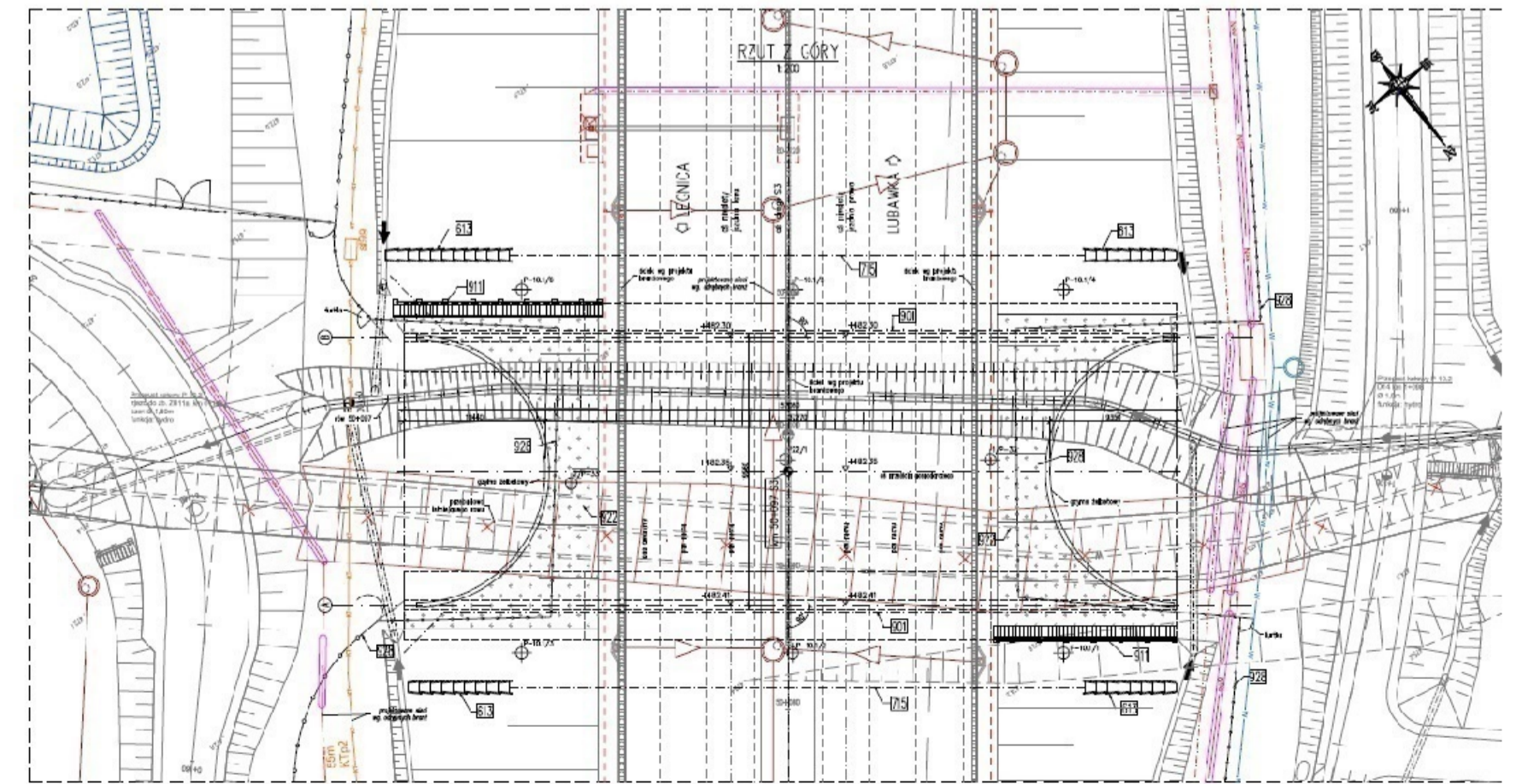
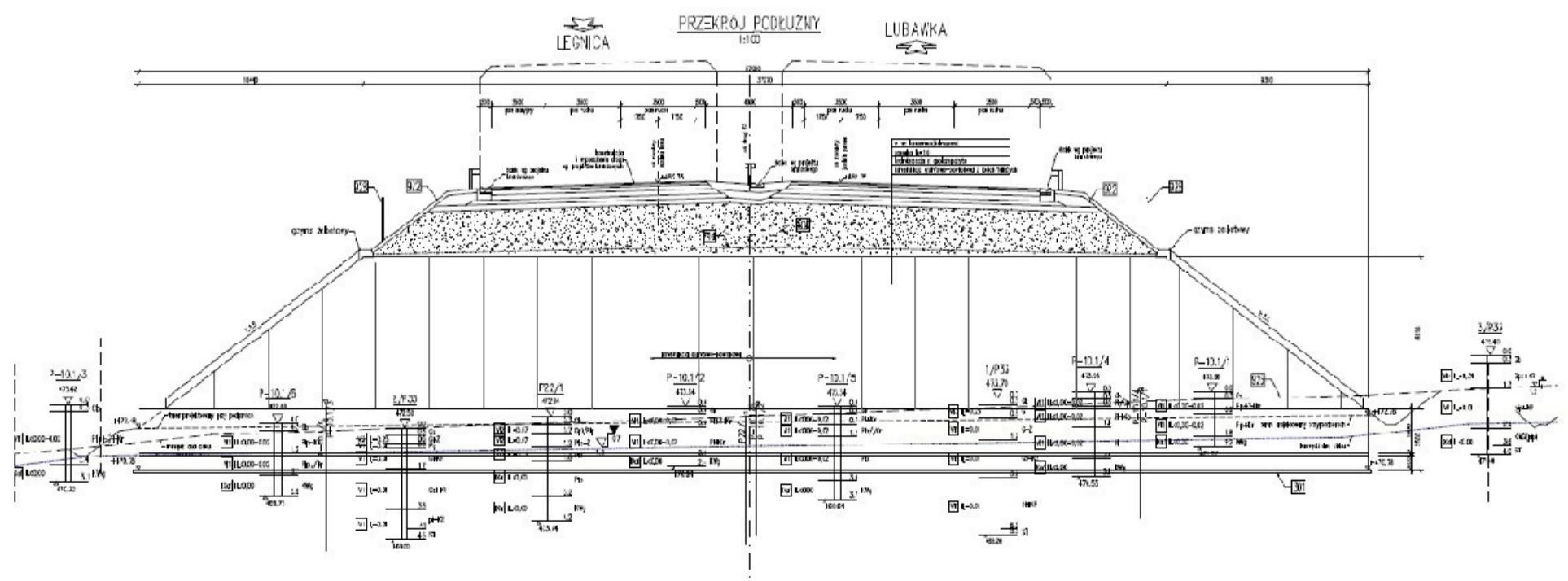



**WS-33**  
km 49+530,70

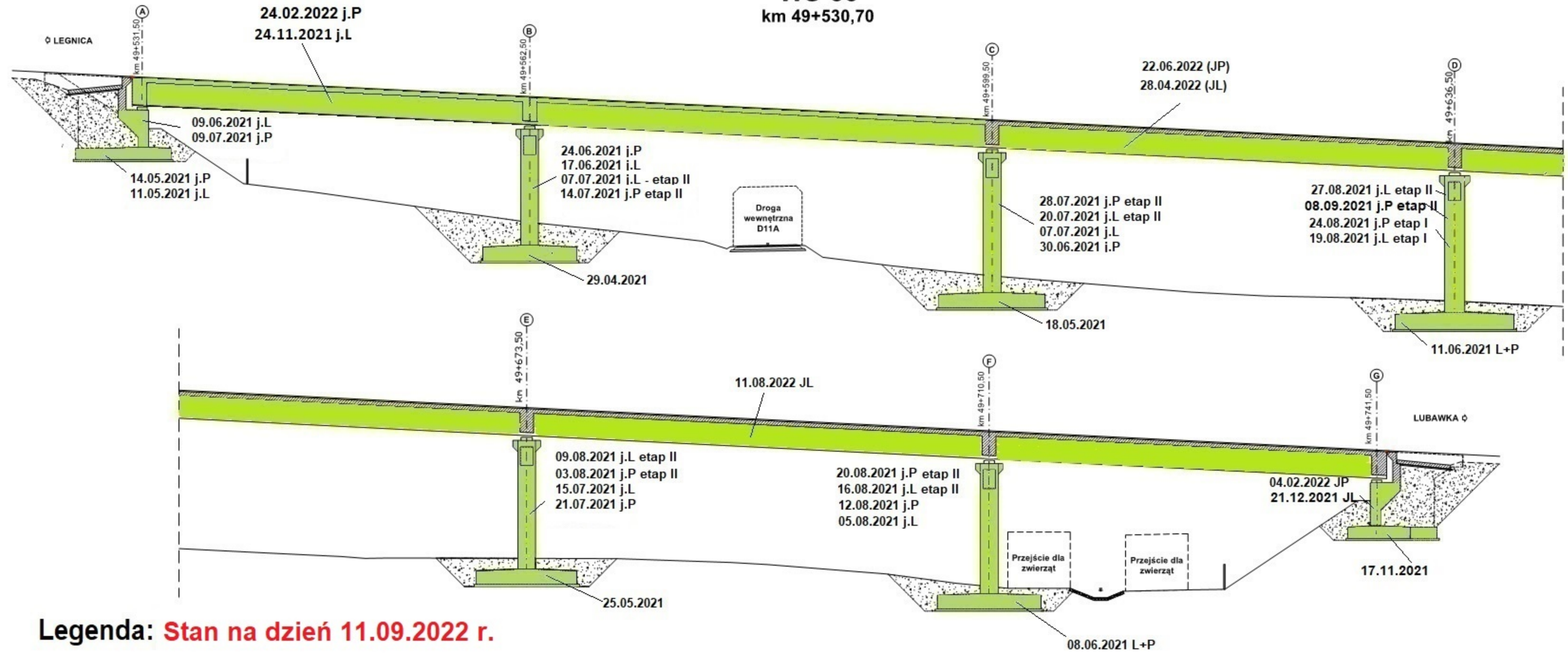

**Legenda: Stan na dzień 11.09.2022 r.**

- Roboty w trakcie wykonywania
- Roboty zakończone

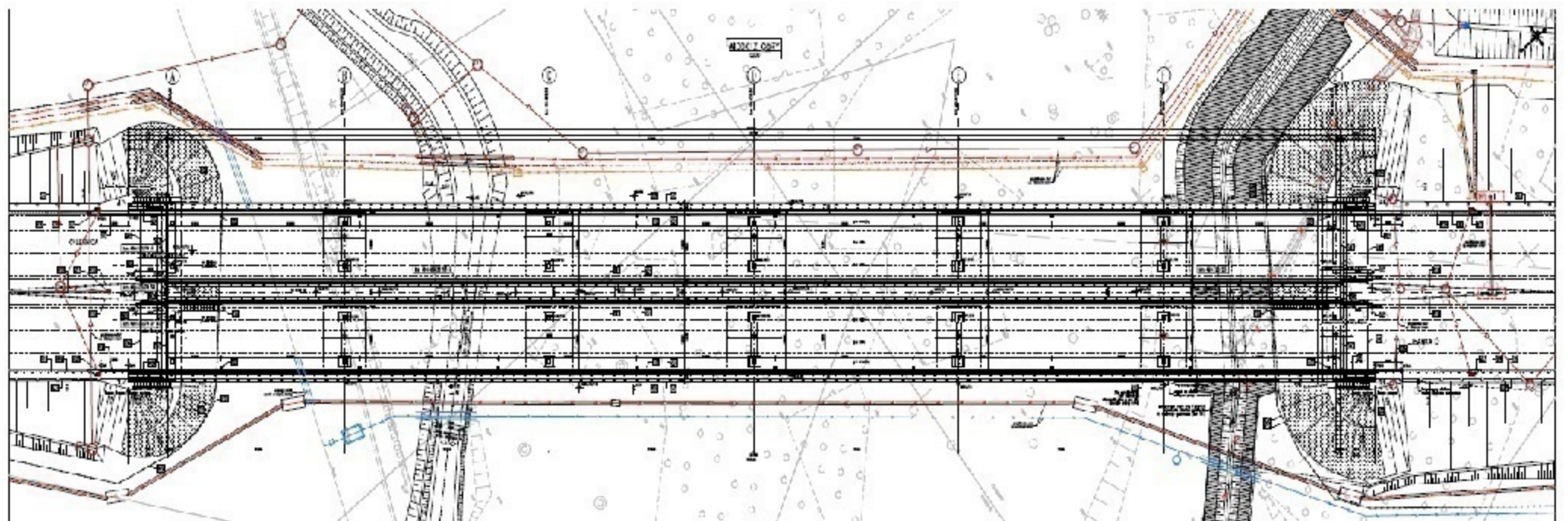
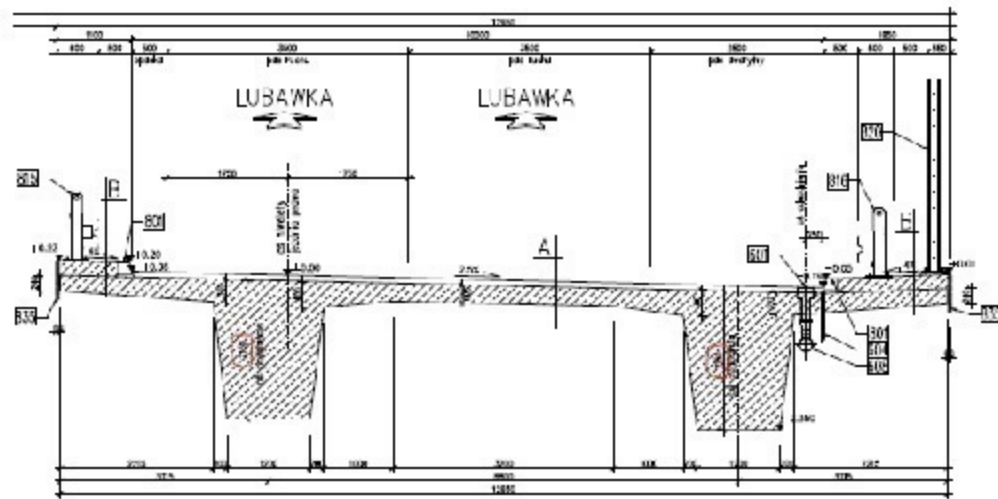



# WD-34

## km 50+661,15

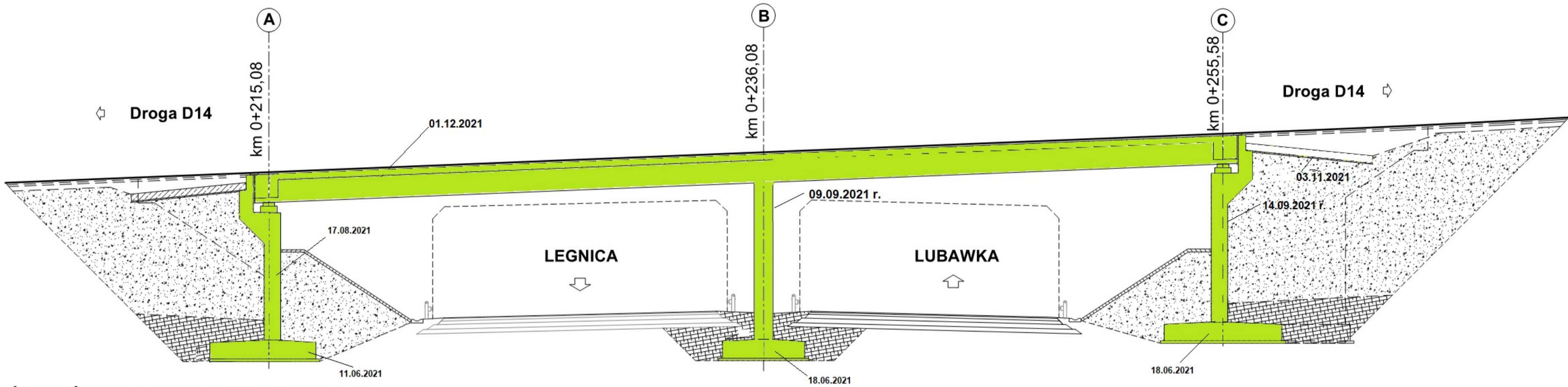

Legenda: Stan na dzień 11.09.2022 r.

- Roboty w trakcie wykonywania
- Roboty zakończone

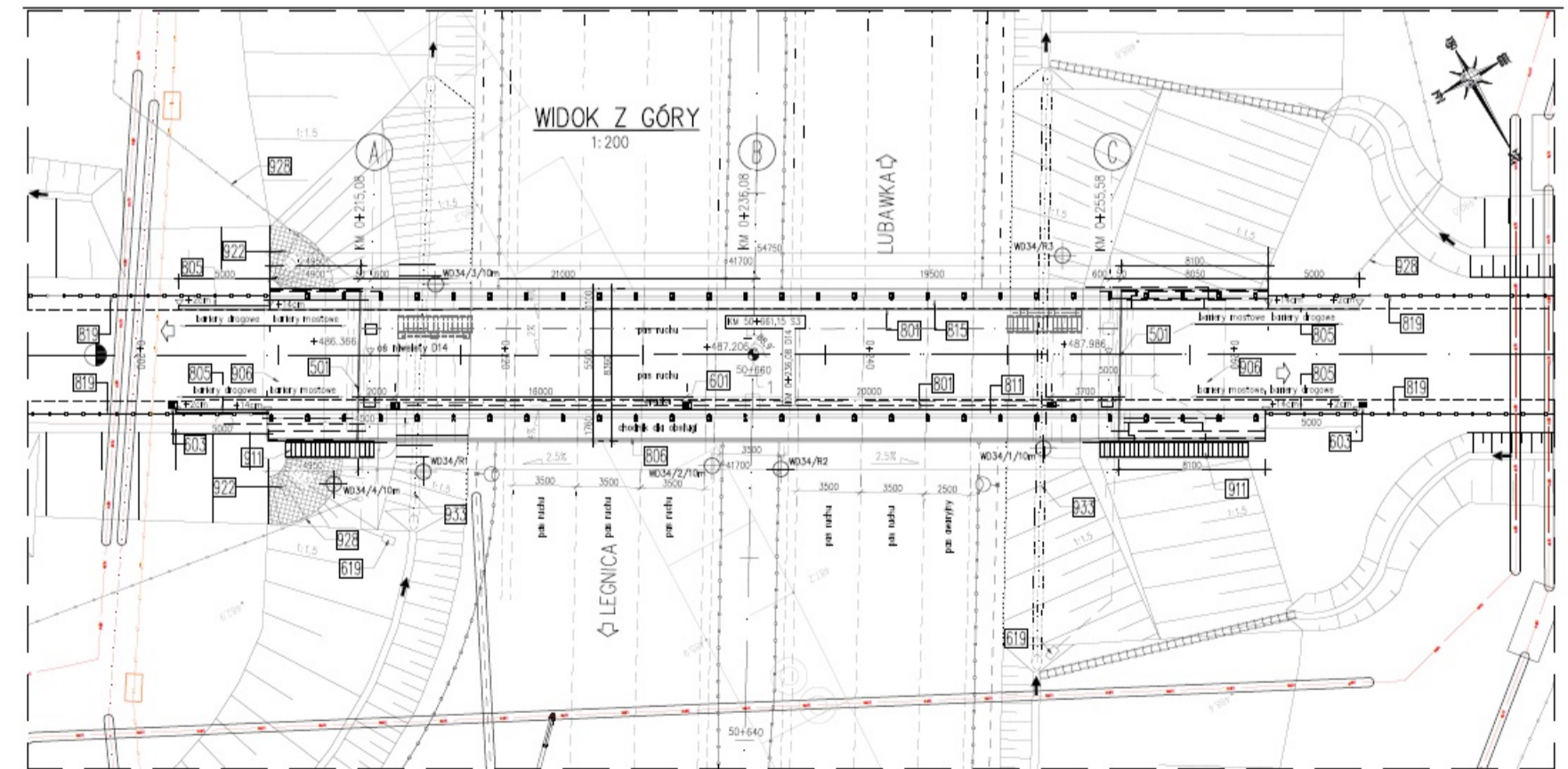
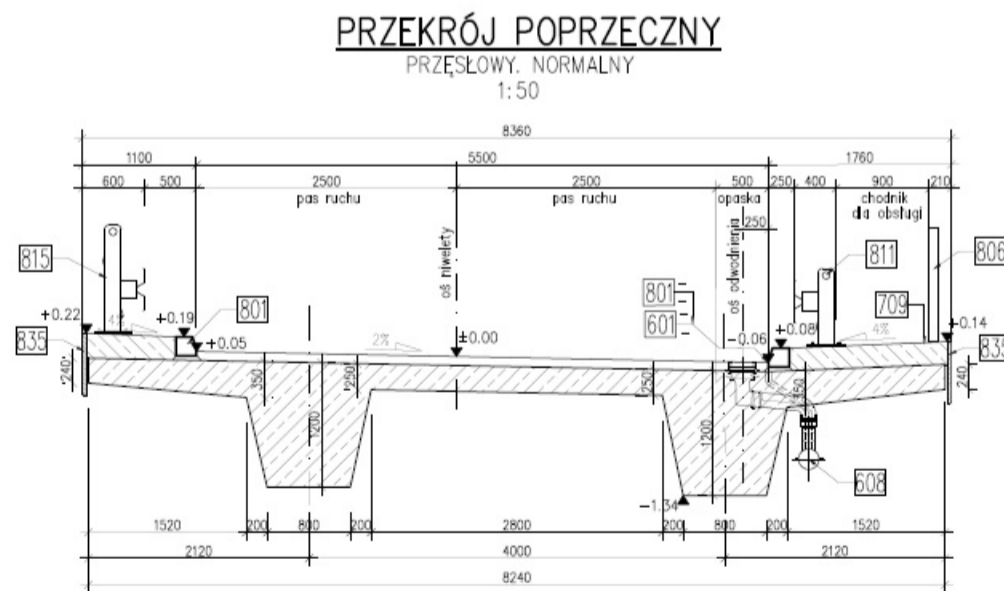



# PG 11.1

## km 51+249,00

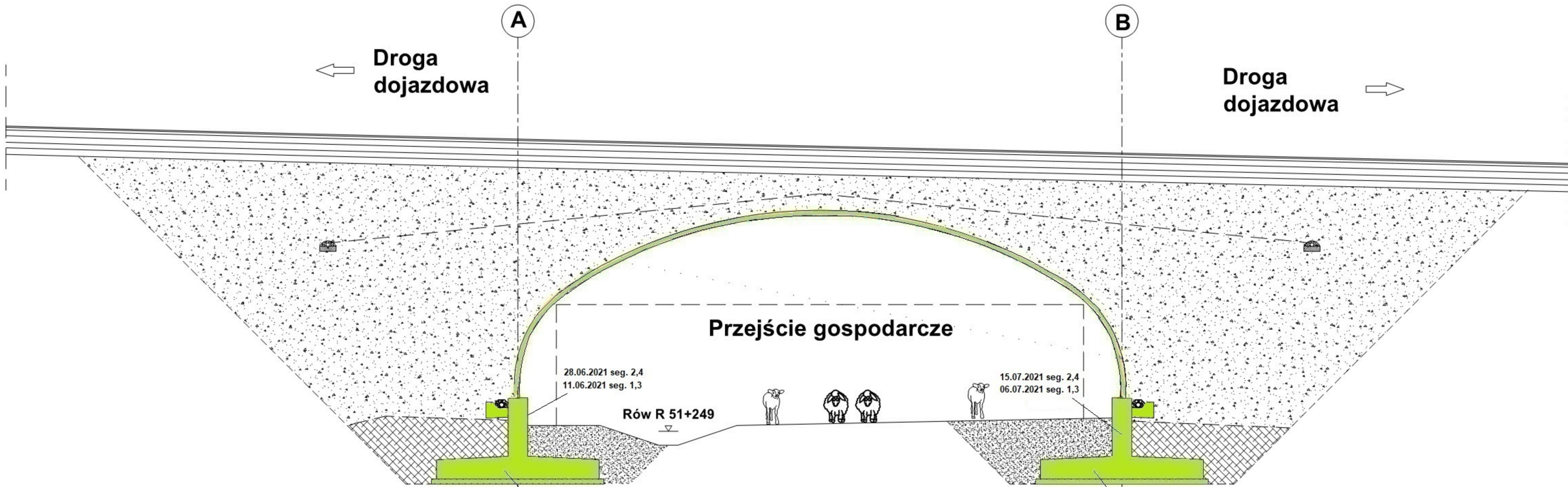

Legenda: Stan na dzień 11.09.2022 r.

- Roboty w trakcie wykonywania
- Roboty zakończone

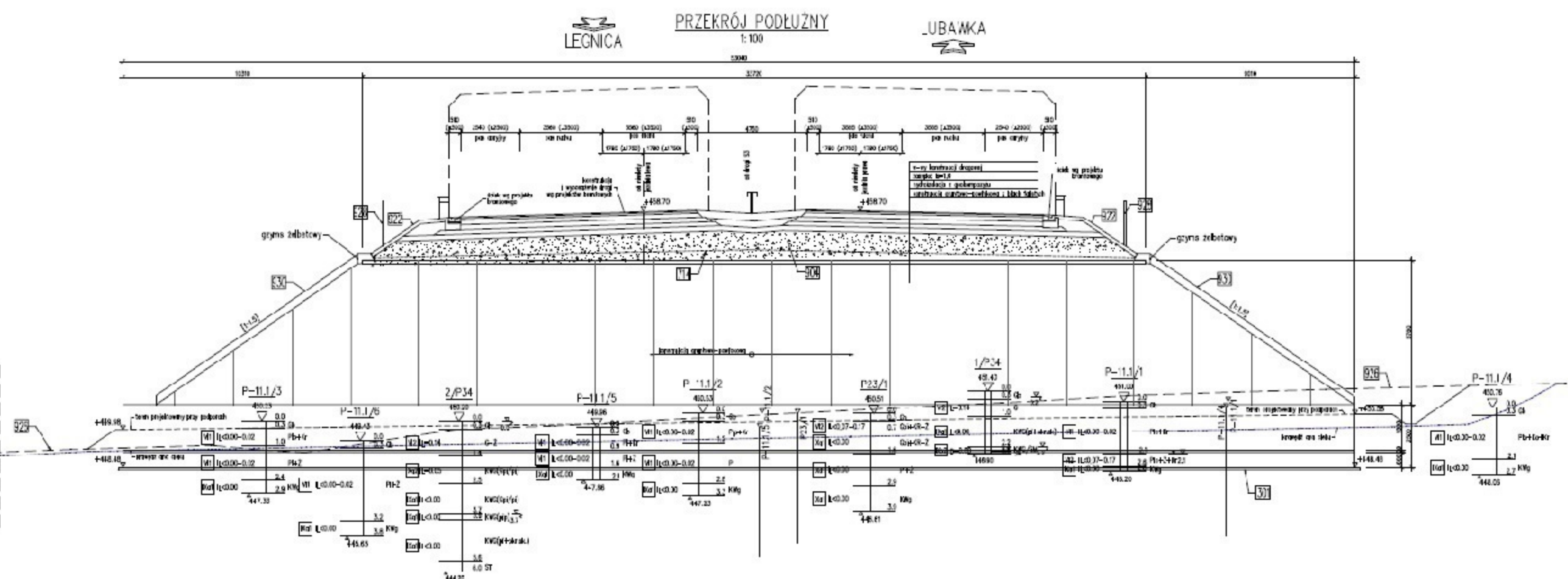



# WS-35 km 51+508,81

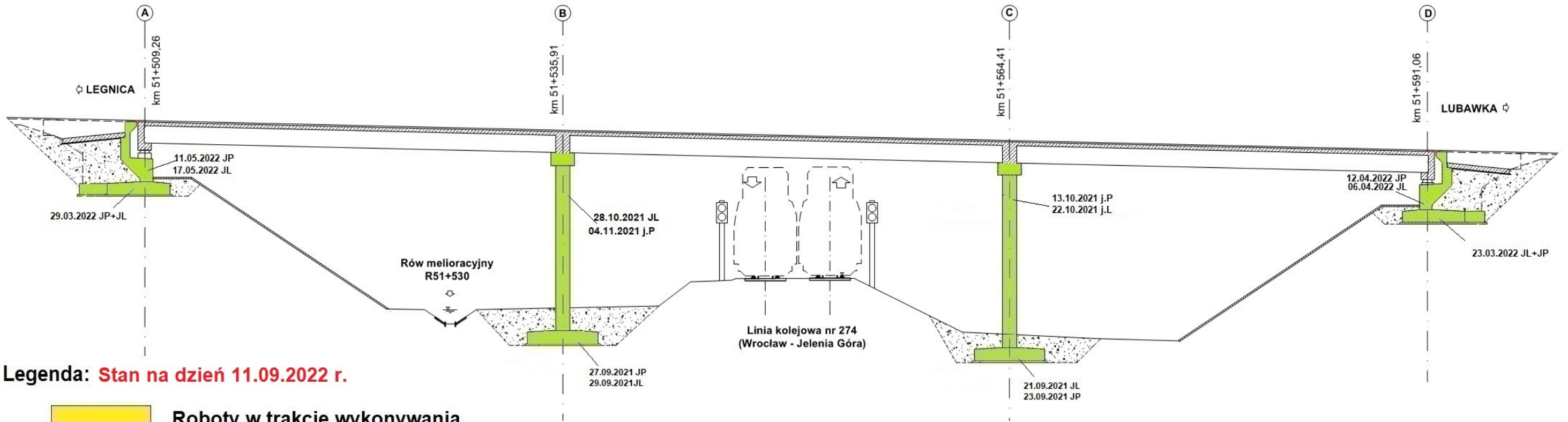

Legenda: Stan na dzień 11.09.2022 r.

- Roboty w trakcie wykonywania
- Roboty zakończone

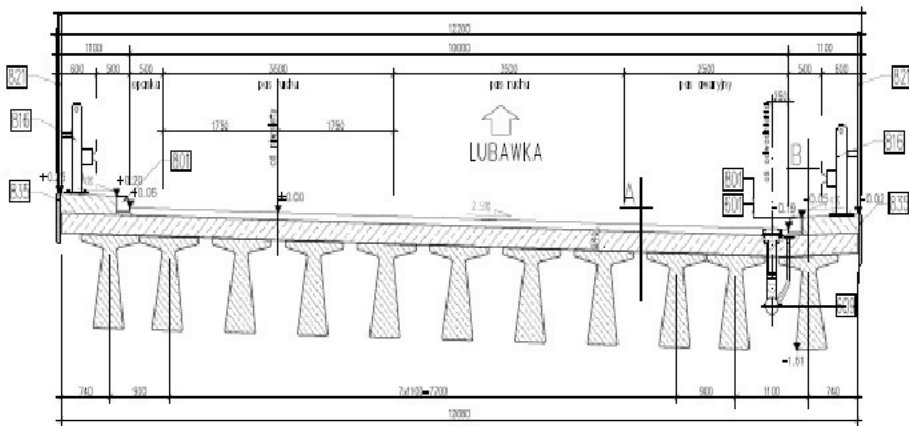



# WS-36

## km 51+780,95

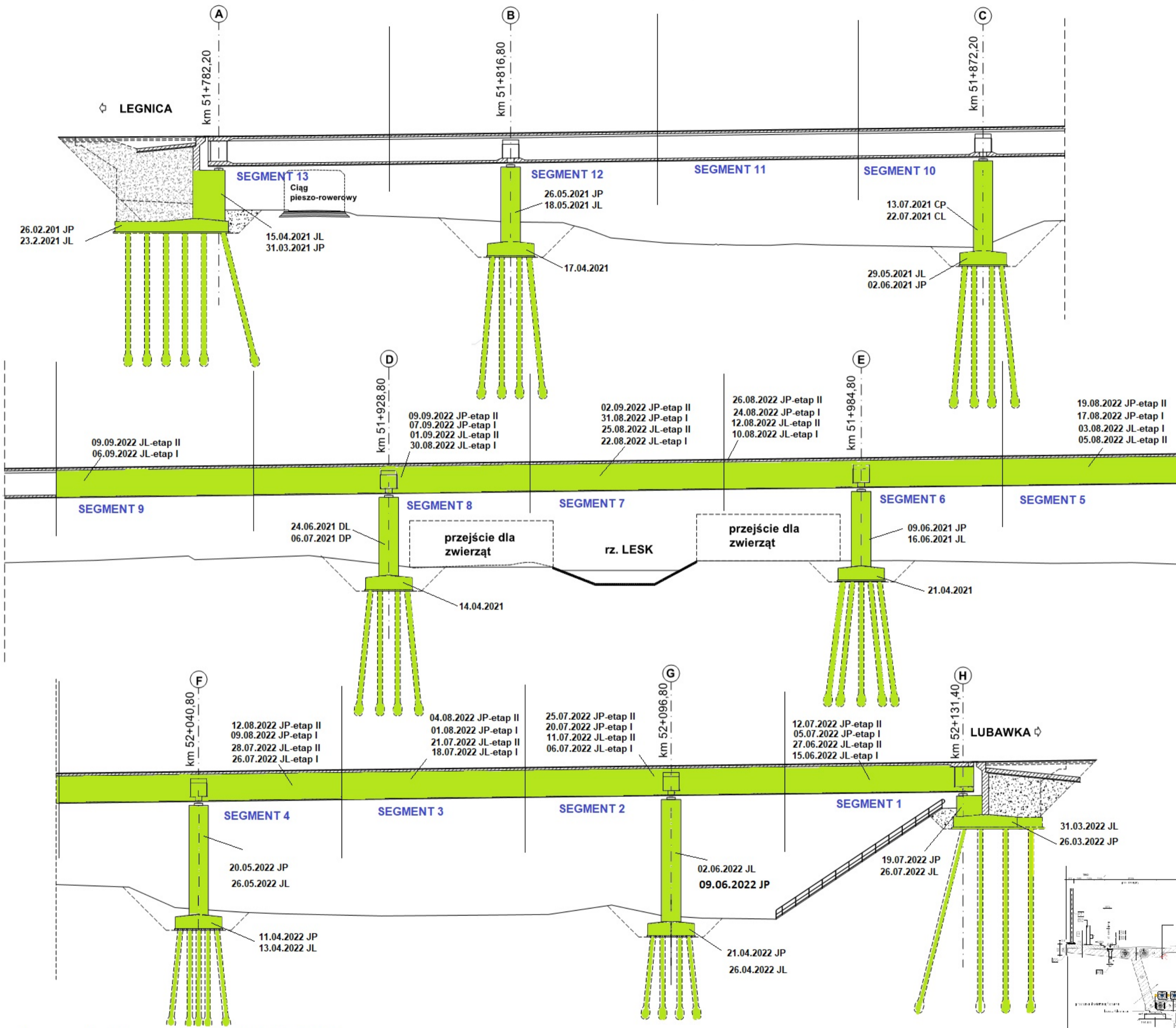

Legenda: Stan na dzień 11.09.2022 r.

- Roboty w trakcie wykonywania
- Roboty zakończone

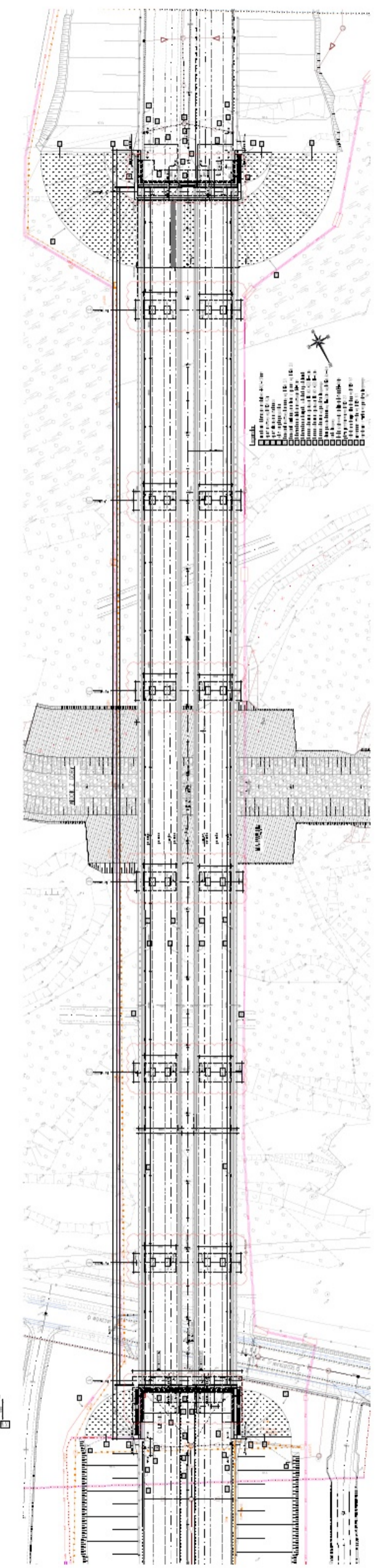
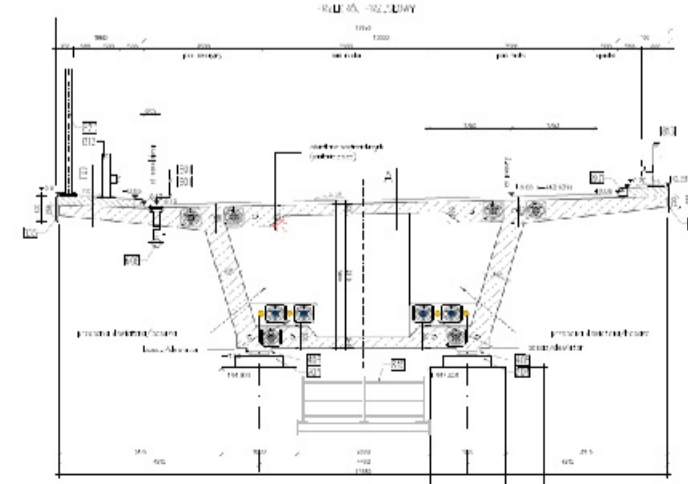



# WS-37

## km 52+994,25

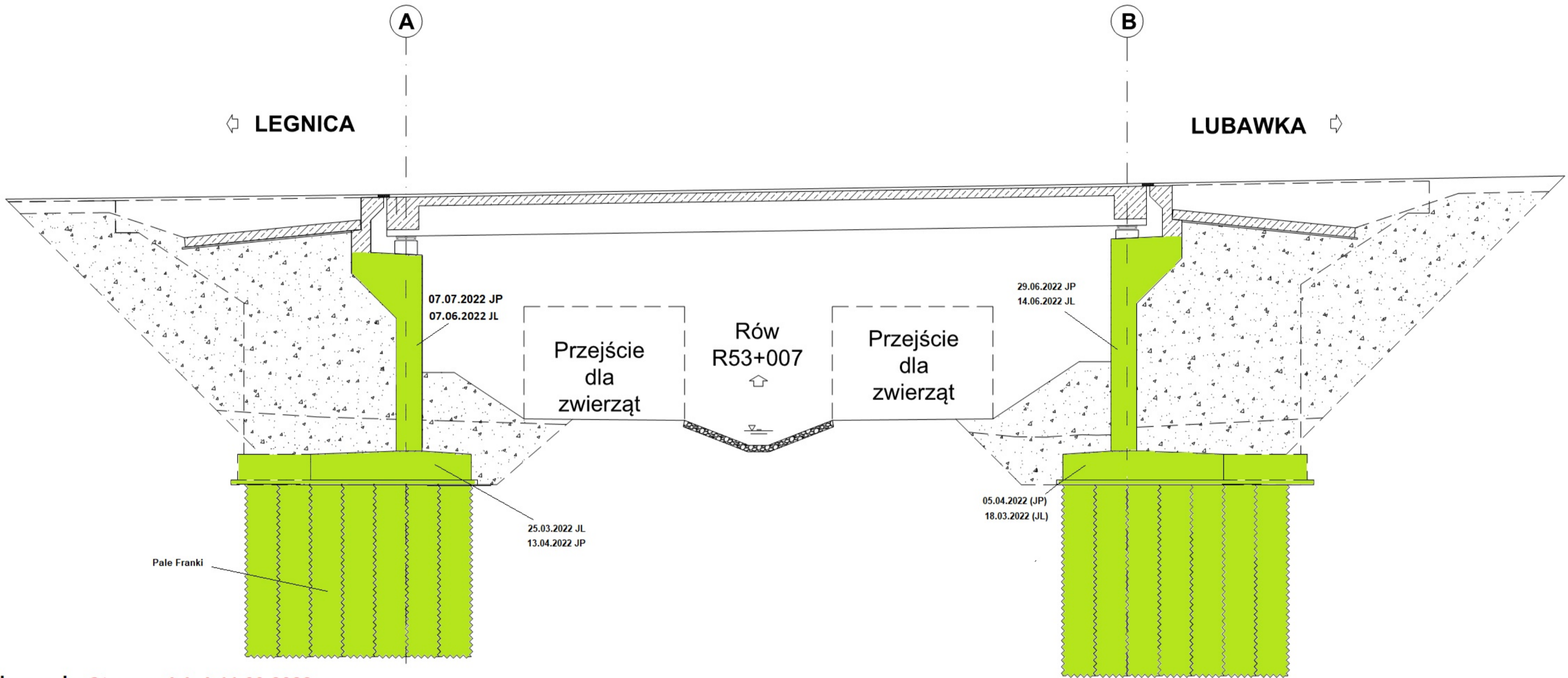

Legenda: Stan na dzień 11.09.2022 r.

- Roboty w trakcie wykonywania
- Roboty zakończone

PRZEKRÓJ POPRZECZNY  
PRZEŚLONY NORMALNY  
1:50

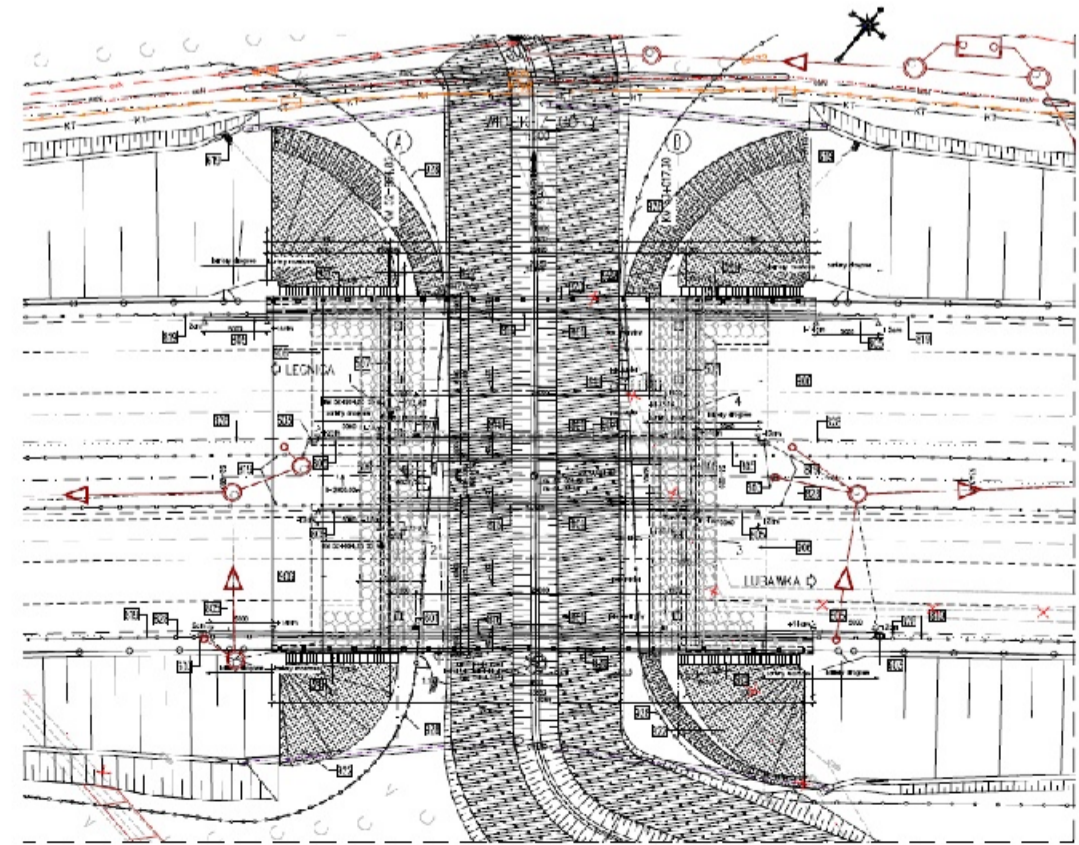
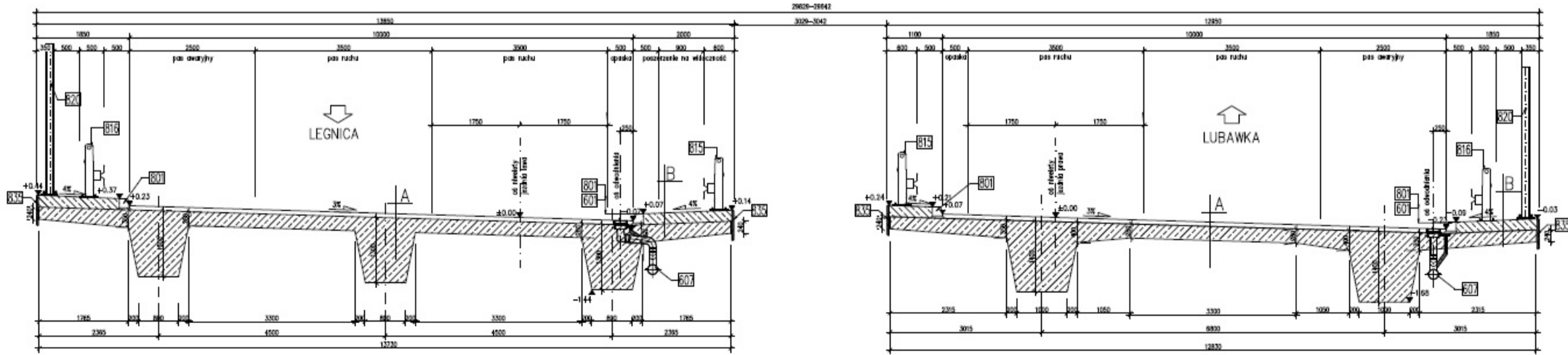



# WD-38

km 53+798,79

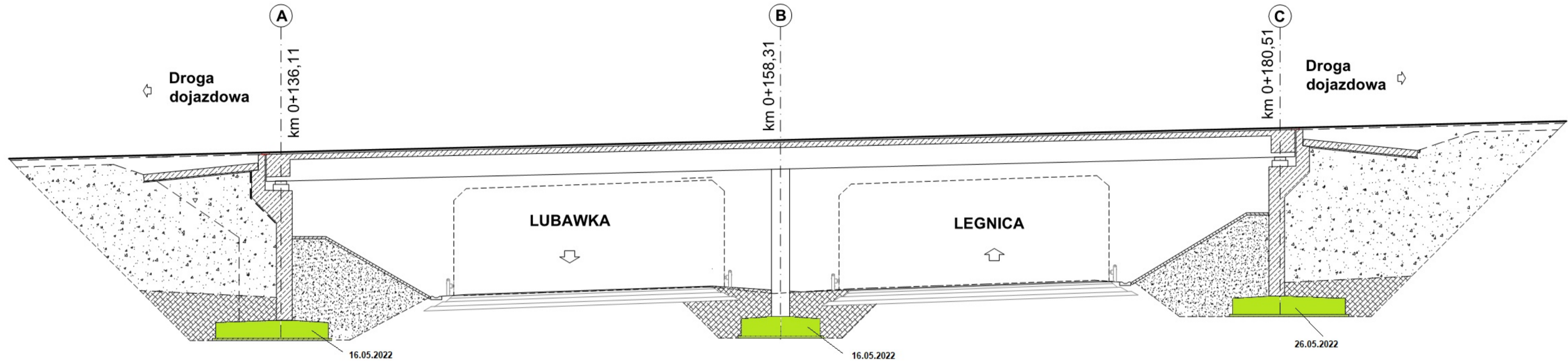

Legenda: **Stan na dzień 11.09.2022 r.**

- Roboty w trakcie wykonywania
- Roboty zakończone

PRZEKRÓJ POPRZECZNY  
PRZESŁONY NORMATYWY  
1:30

