

WD-22

km 38+491,21

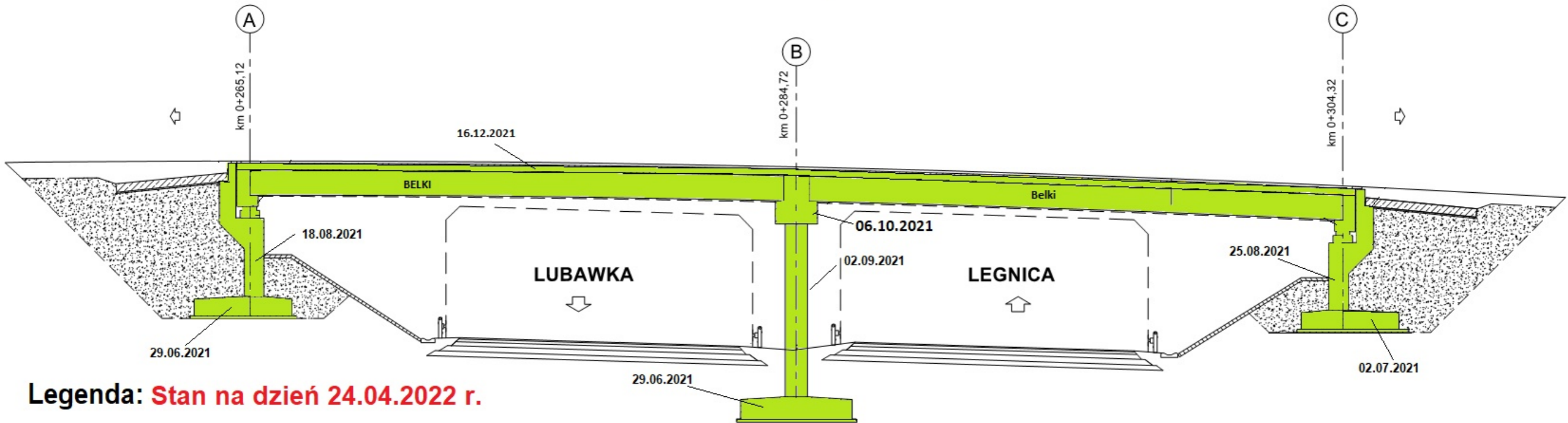

Legenda: Stan na dzień 24.04.2022 r.

-  Roboty w trakcie wykonywania
-  Roboty zakończone

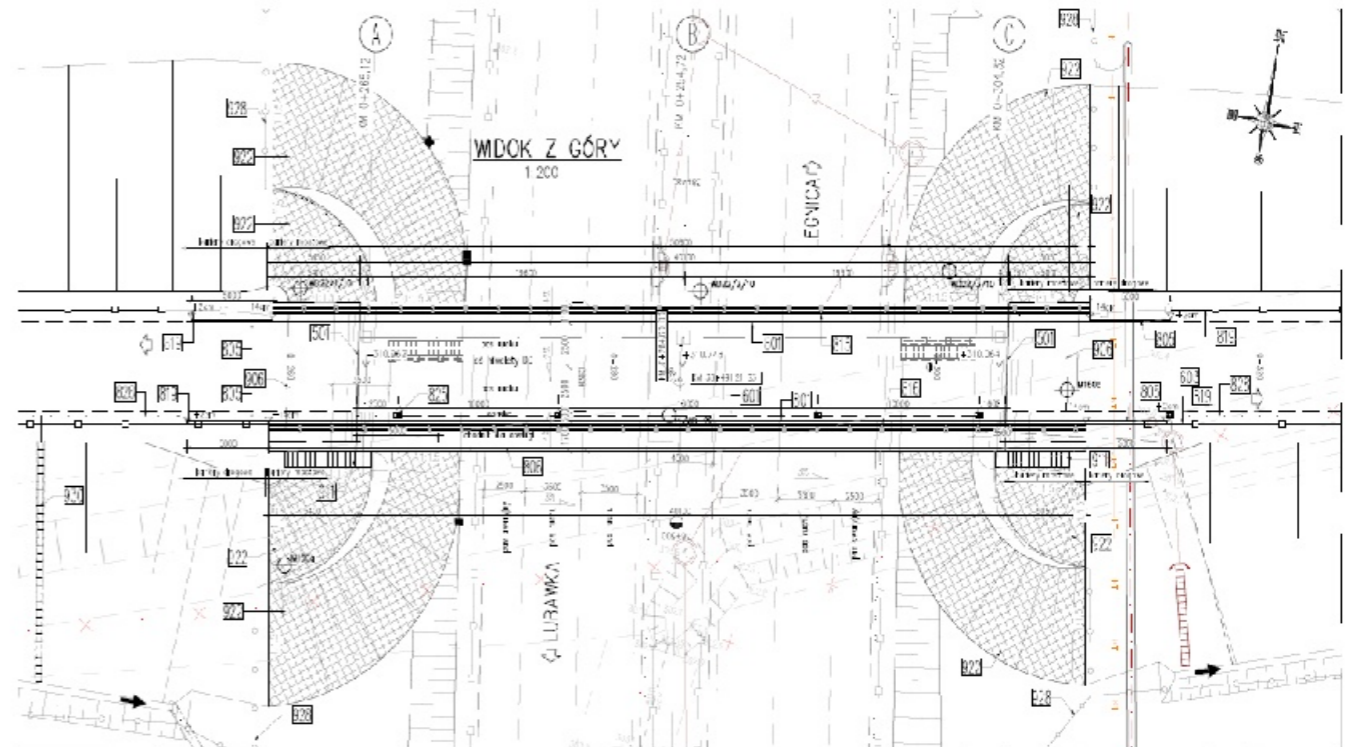

WS-24

km 41+431,41

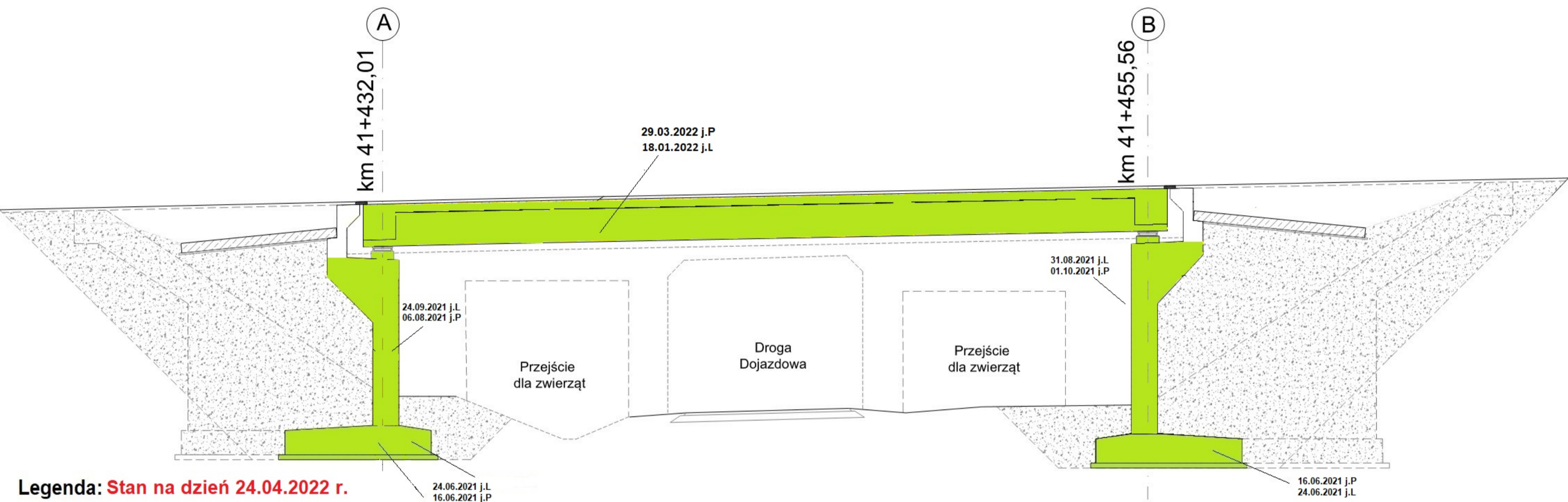

Legenda: Stan na dzień 24.04.2022 r.

- Roboty w trakcie wykonywania
- Roboty zakończone

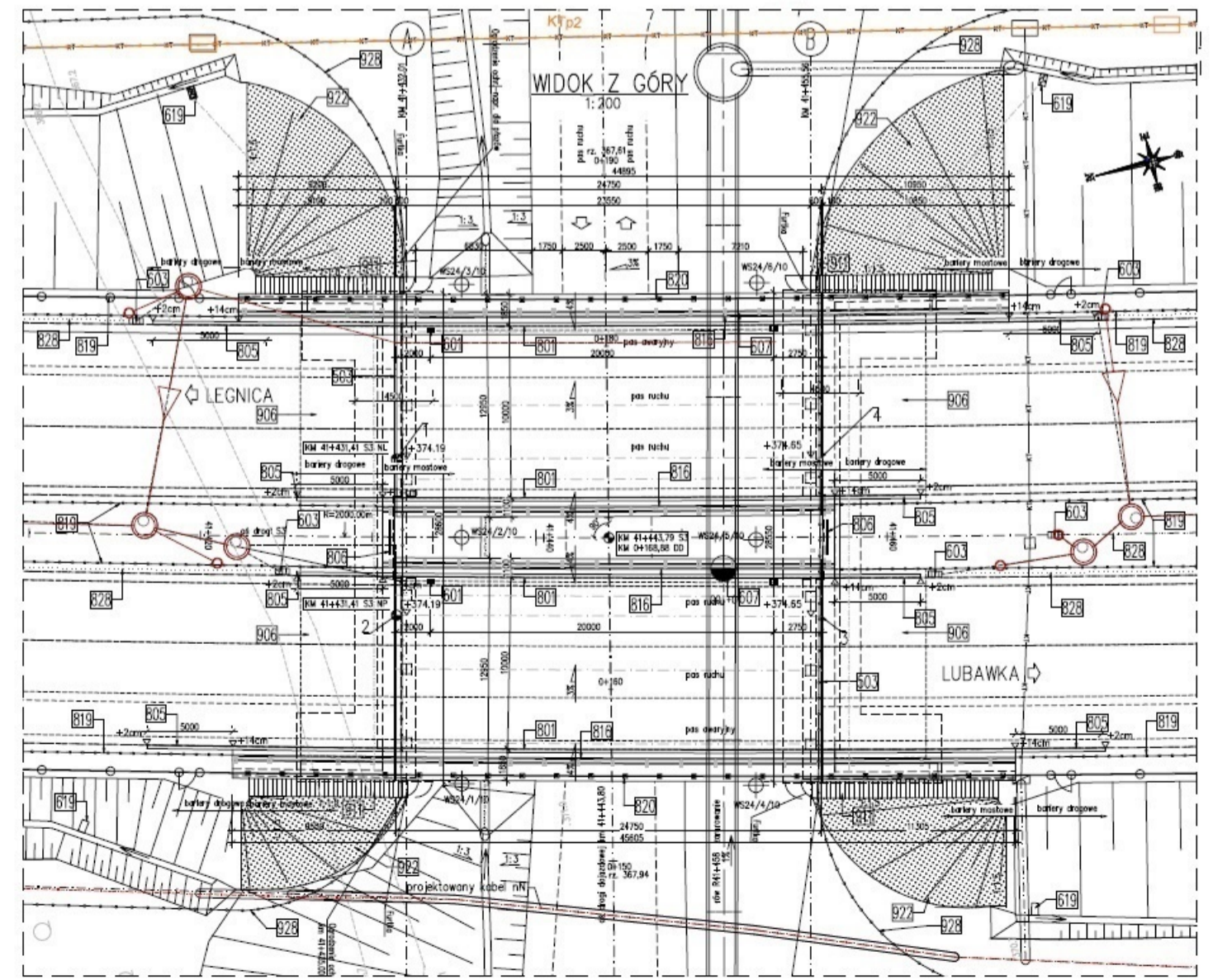
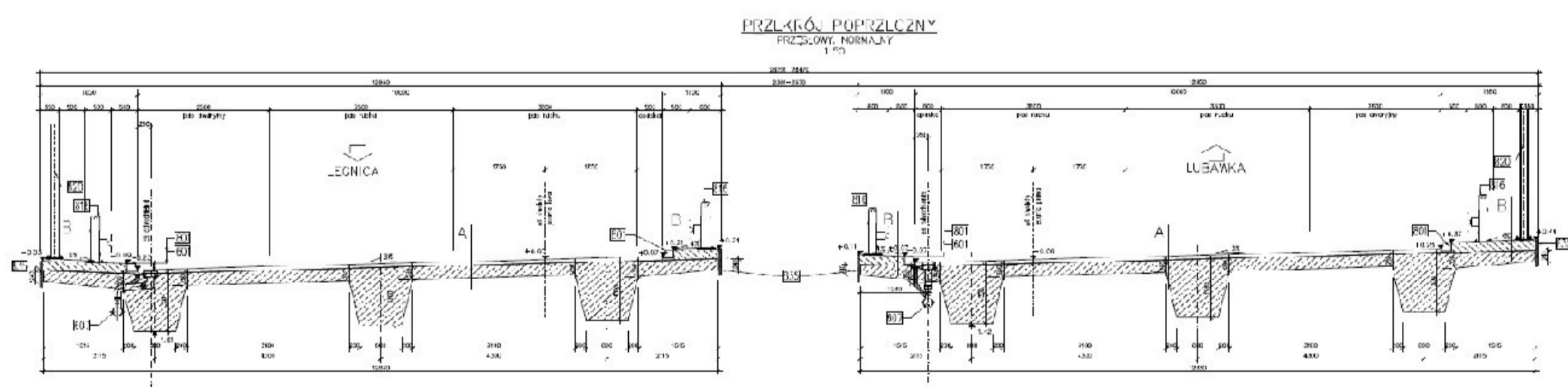

MS-25

km 41+996,65

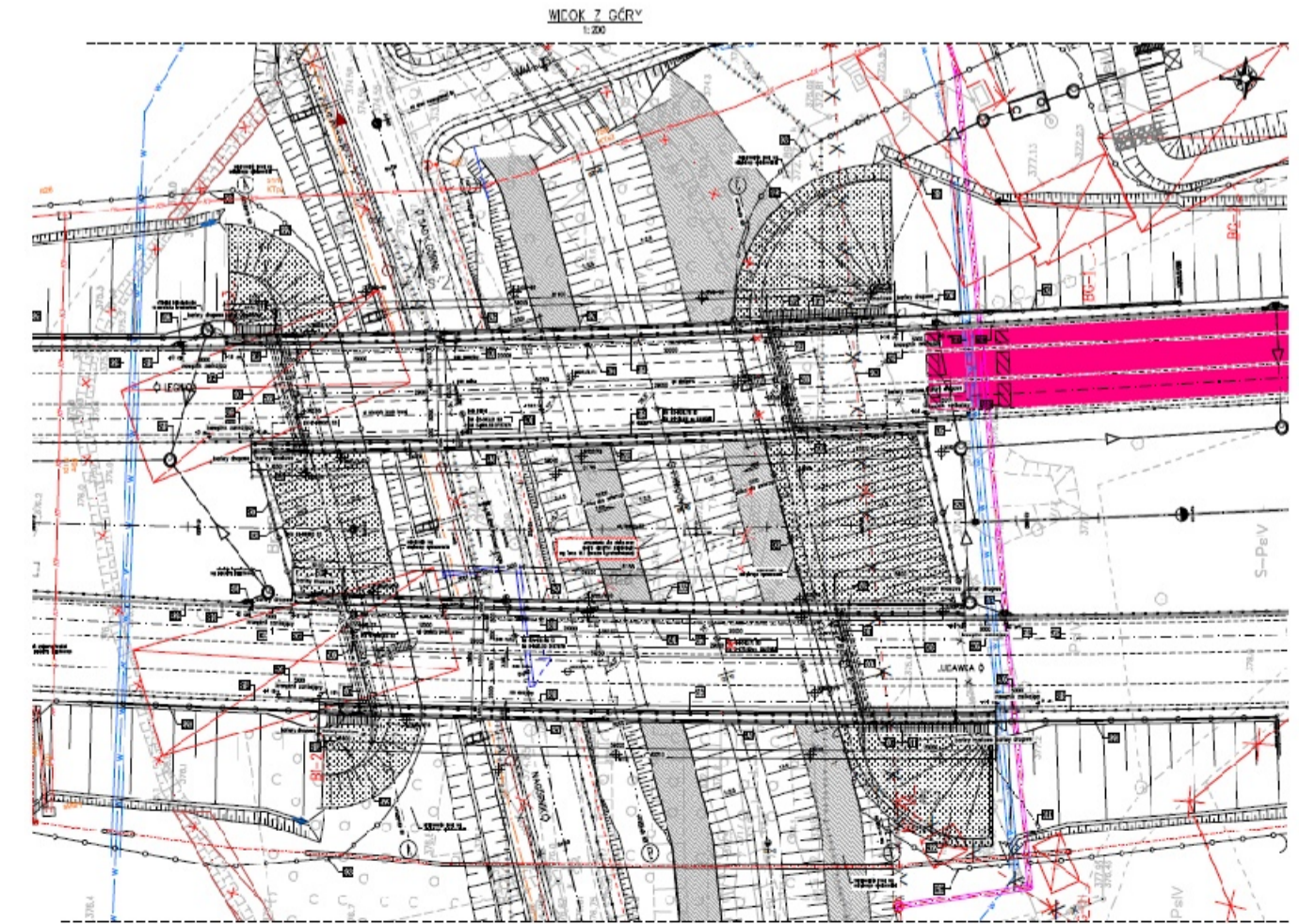
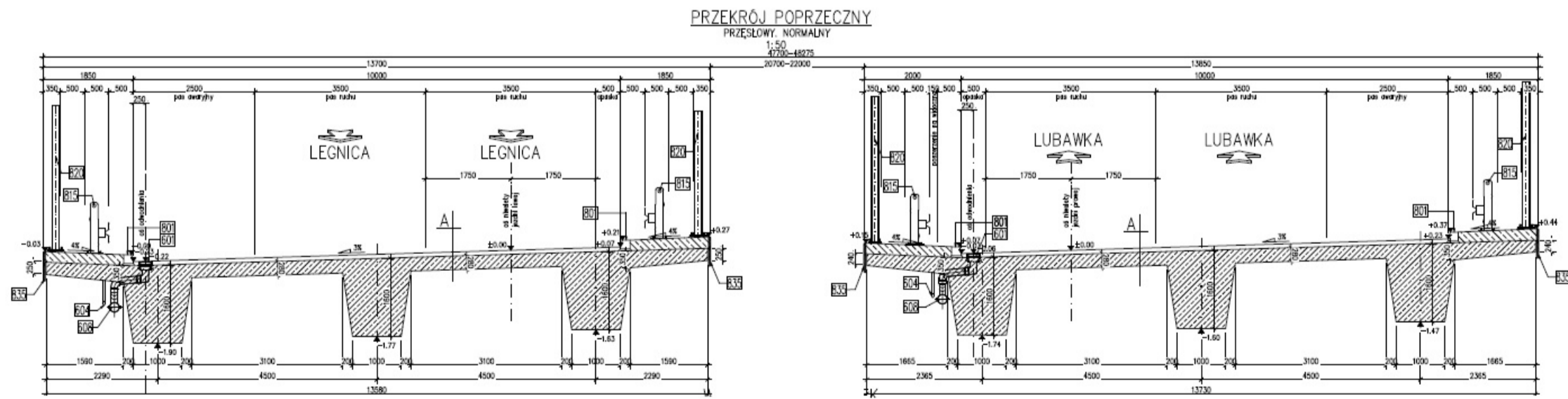
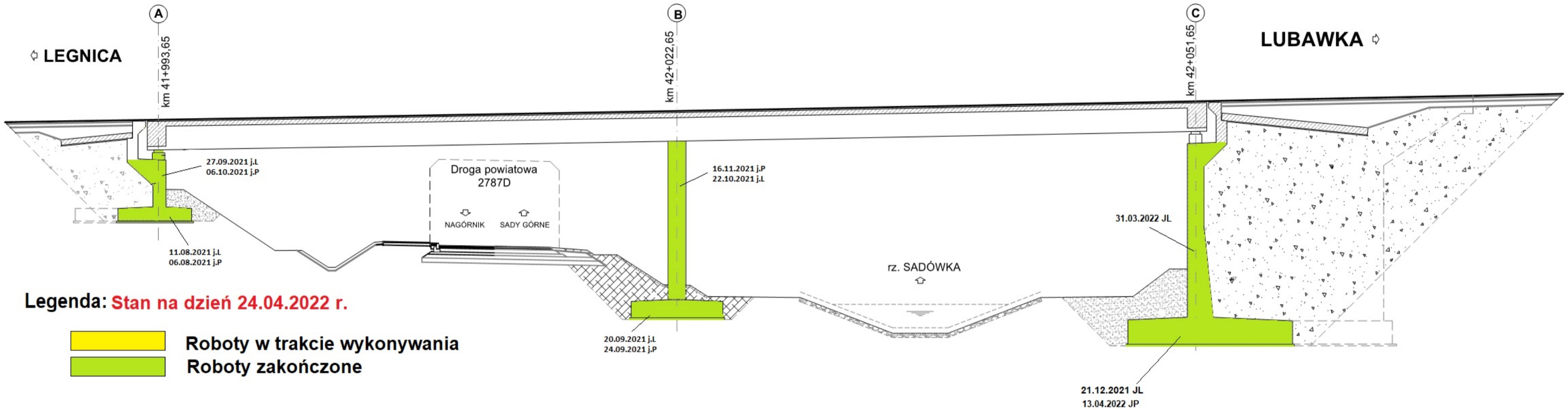

WD-27

km 44+702,77

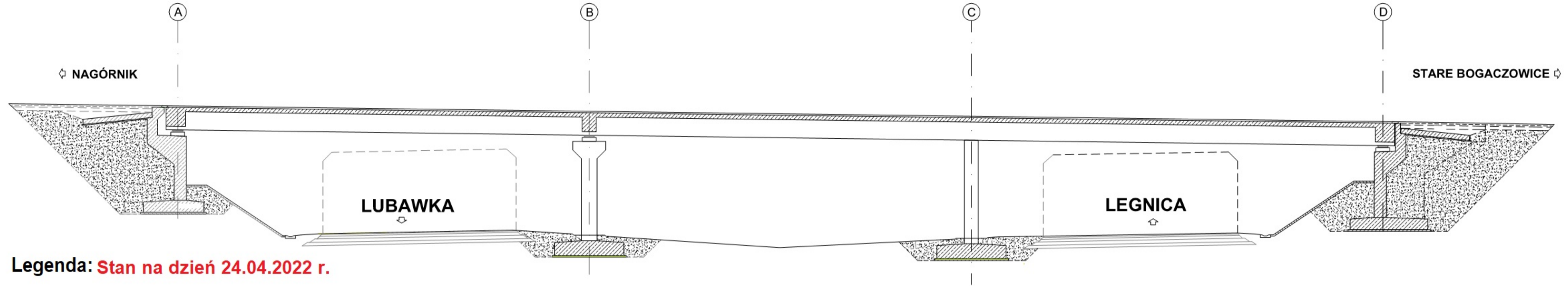

Legenda: Stan na dzień 24.04.2022 r.

- Roboty w trakcie wykonywania
- Roboty zakończone

PRZEKRÓJ POPRZECZNY
Z WIDOKIEM NA FILAR
1:50

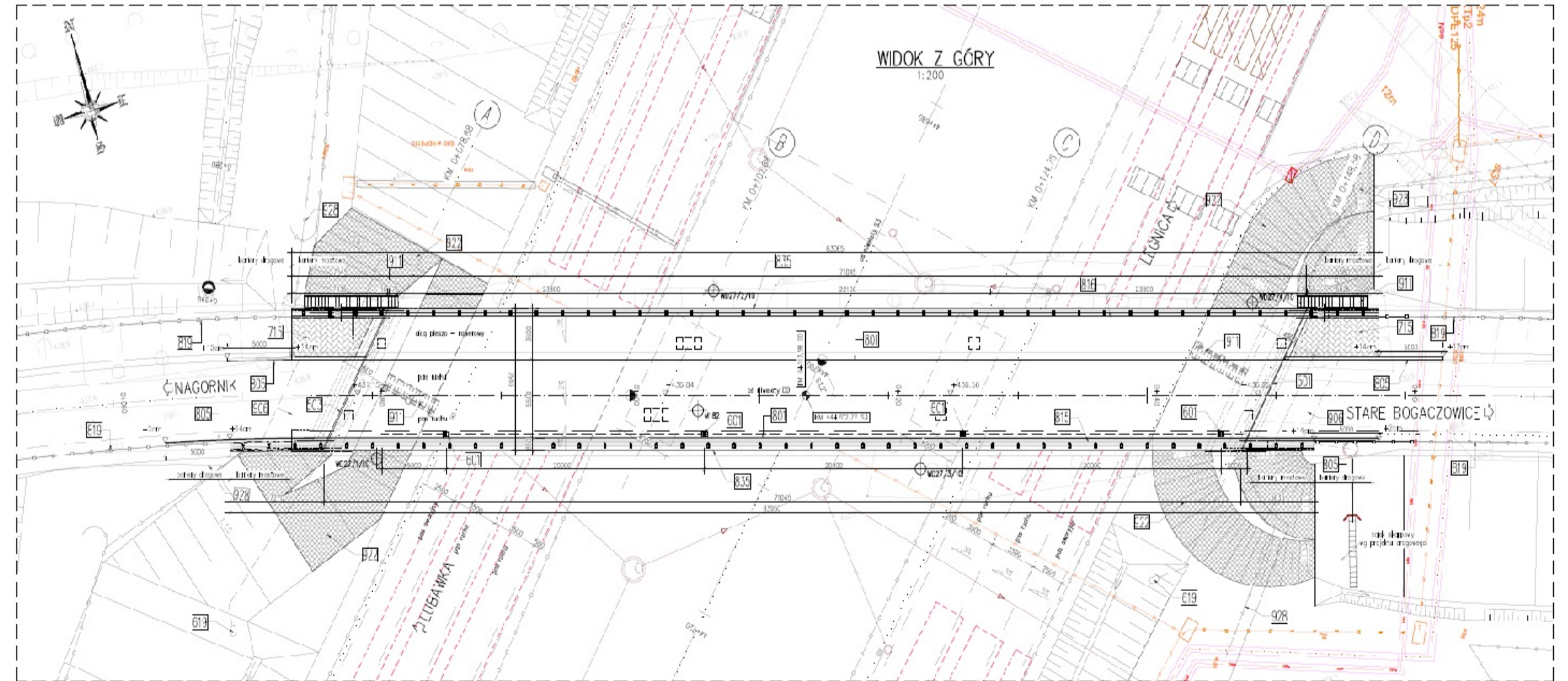
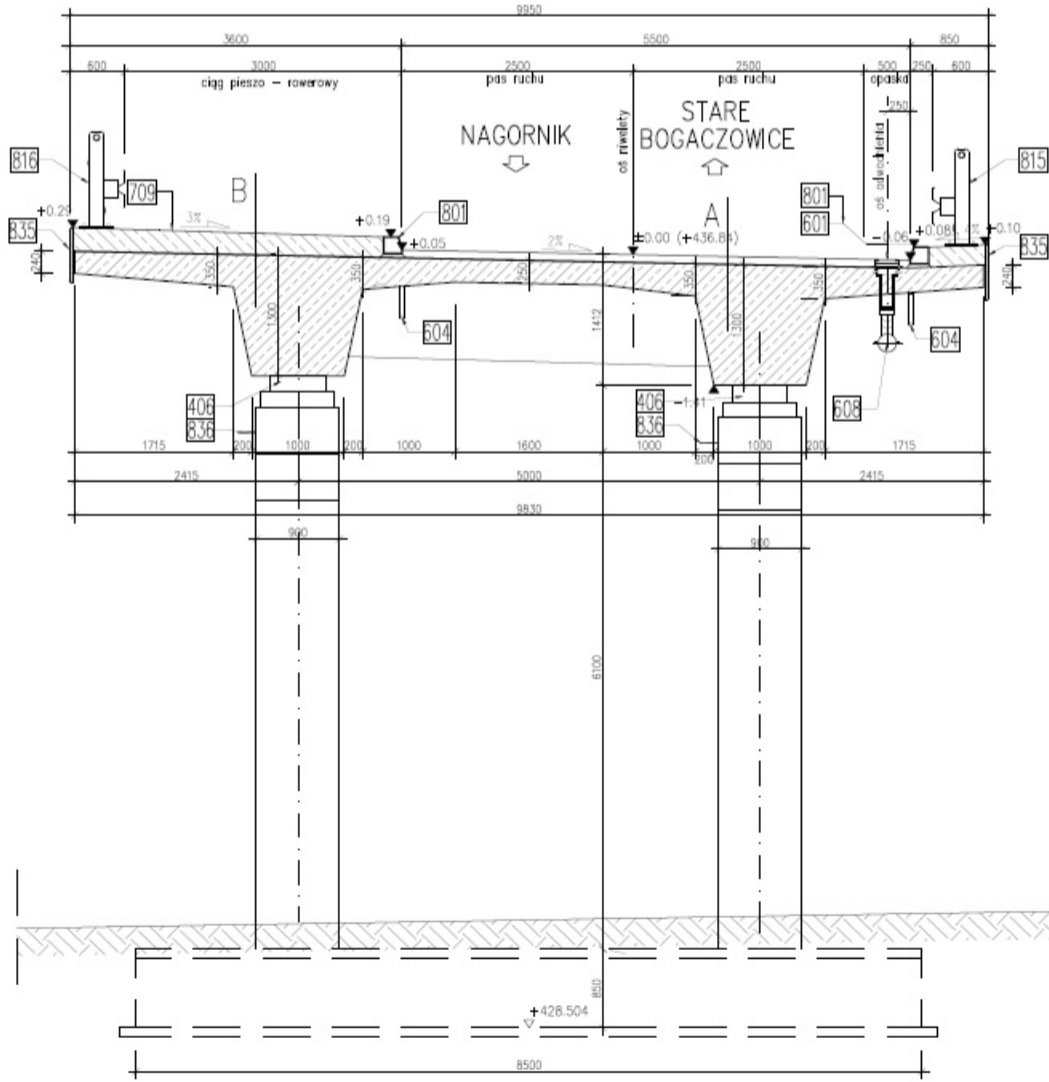

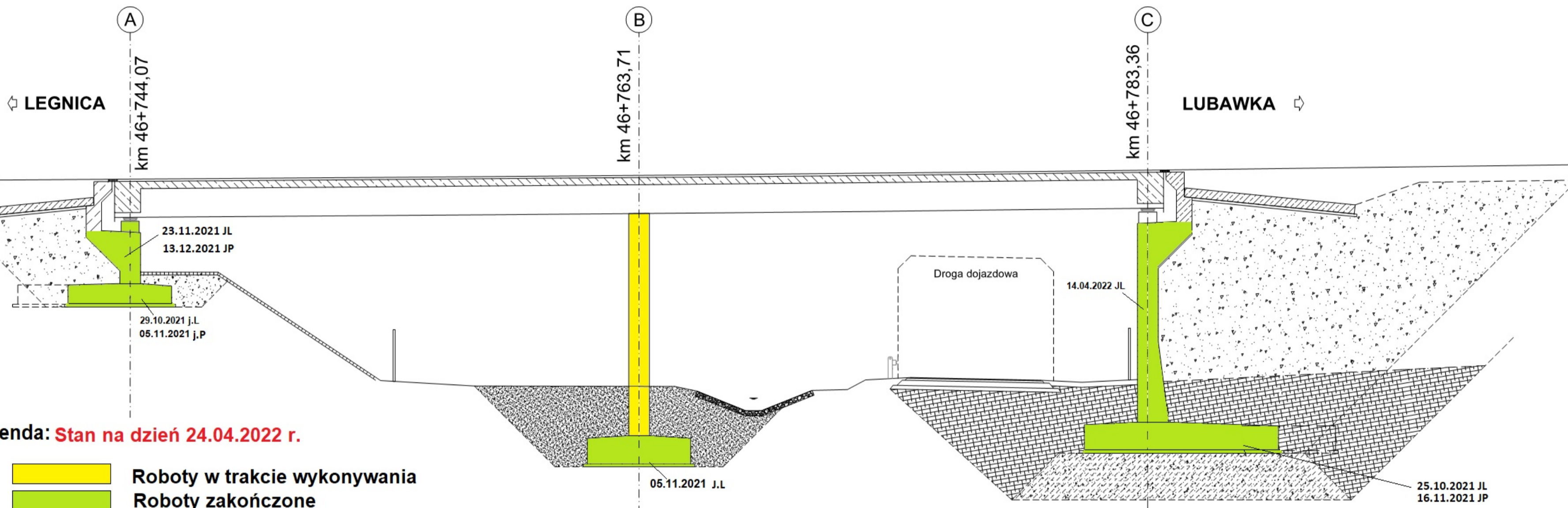

PG-29

km 46+743,46



Legenda: Stan na dzień 24.04.2022 r.

-  Roboty w trakcie wykonywania
-  Roboty zakończone

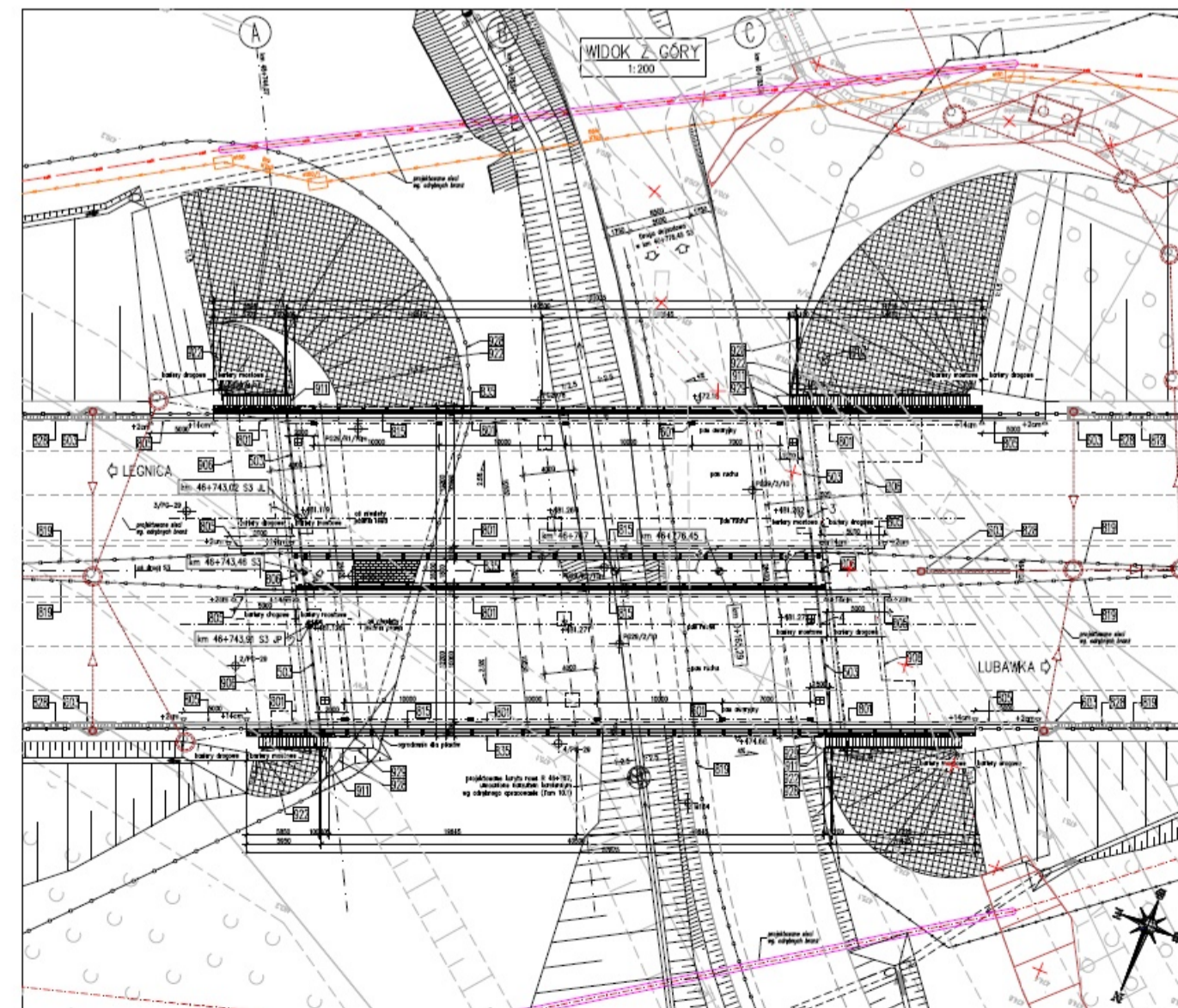
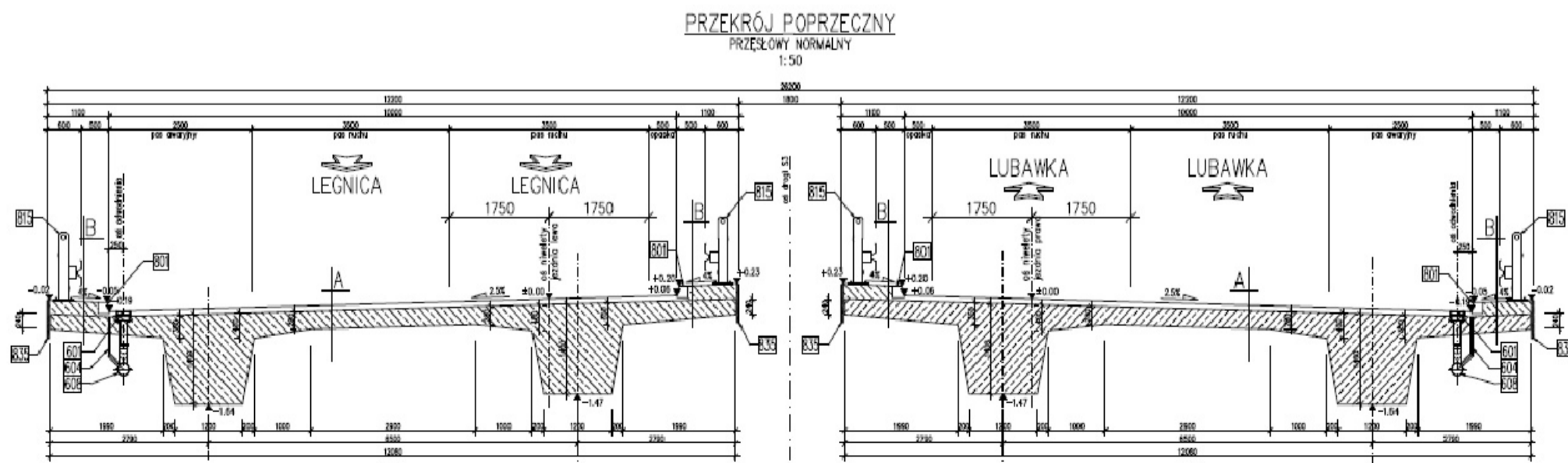

WS-30

km 46+908.42

Legenda: Stan na dzień 24.04.2022 r.

-  Roboty w trakcie wykonywania
-  Roboty zakończone

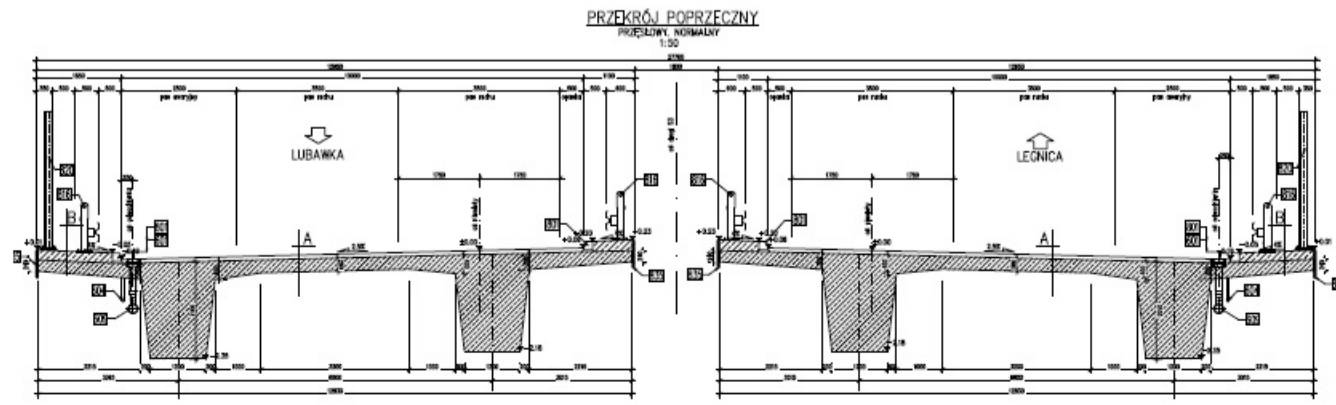
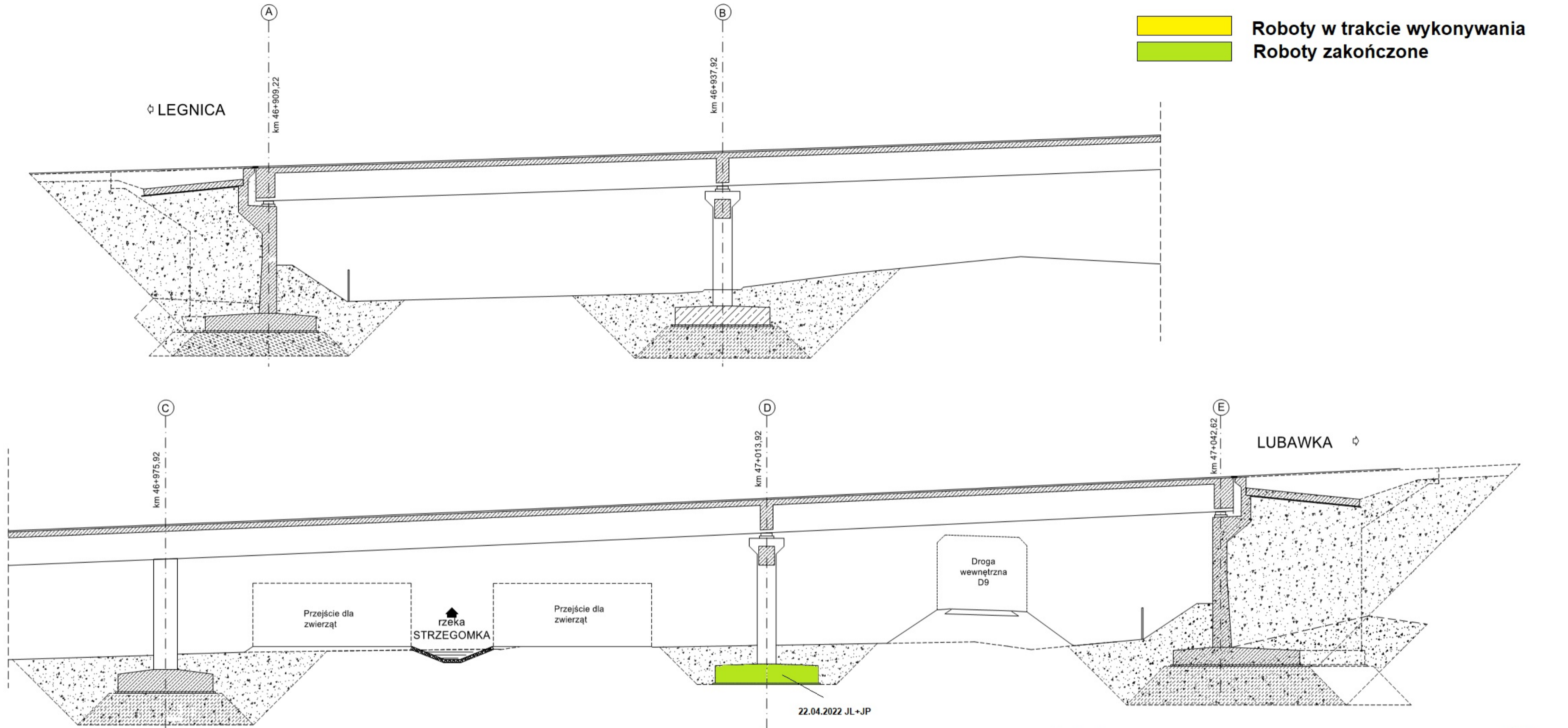

WS-31 km 47+568,12

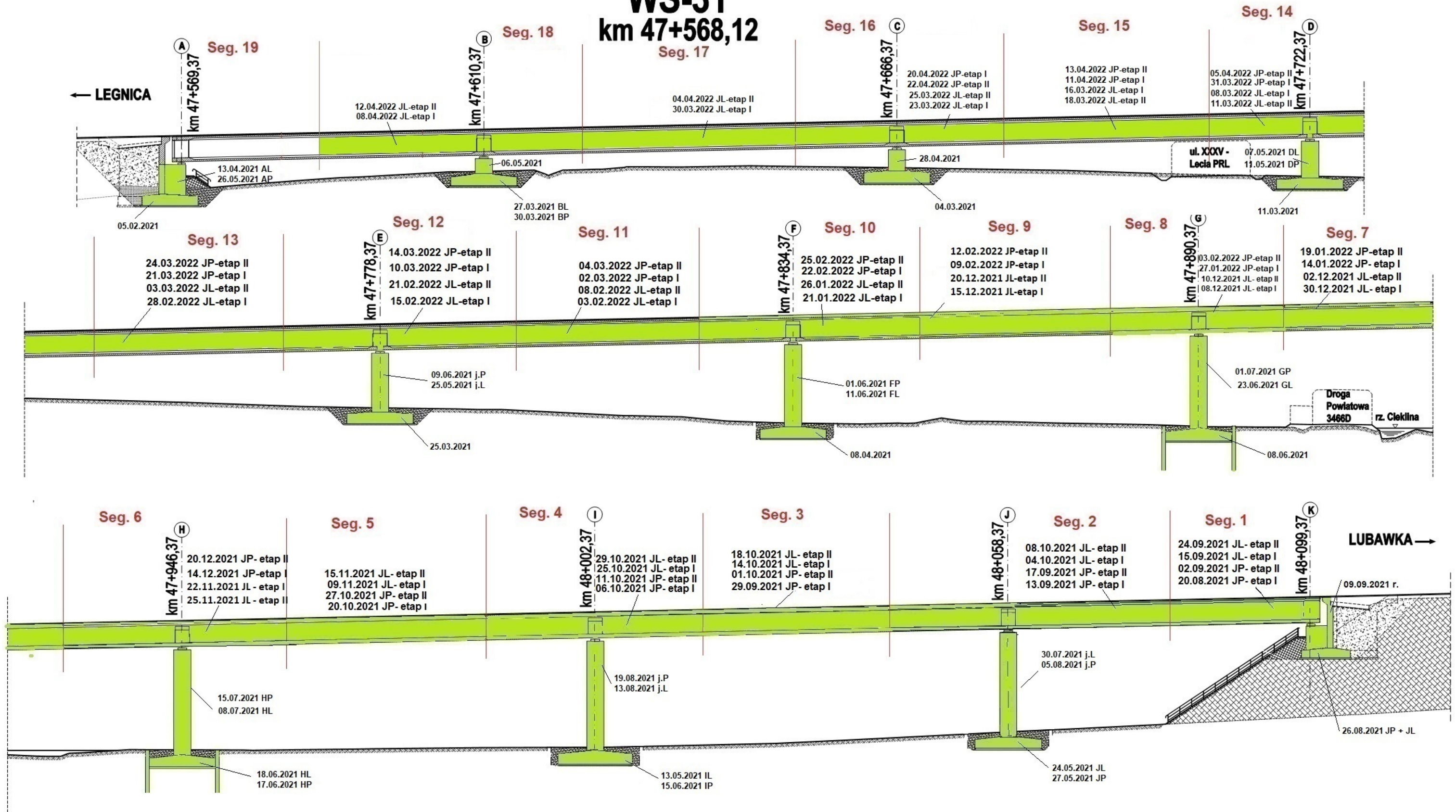

Legenda: Stan na dzień 24.04.2022 r.

- Roboty w trakcie
- Roboty zakończone

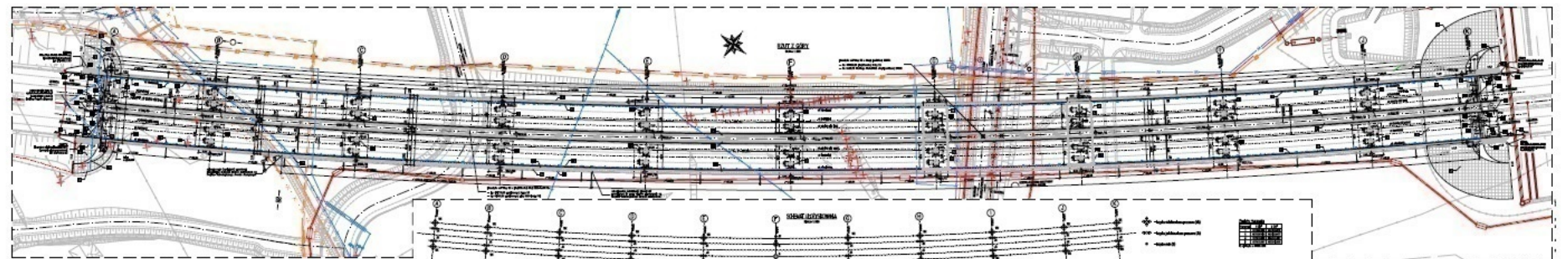
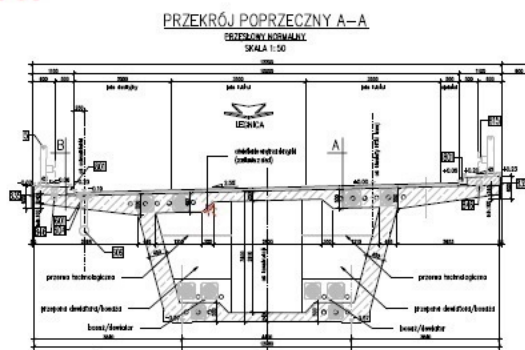

TUNEL TS-32

km 48+680,00 - 49+000,00

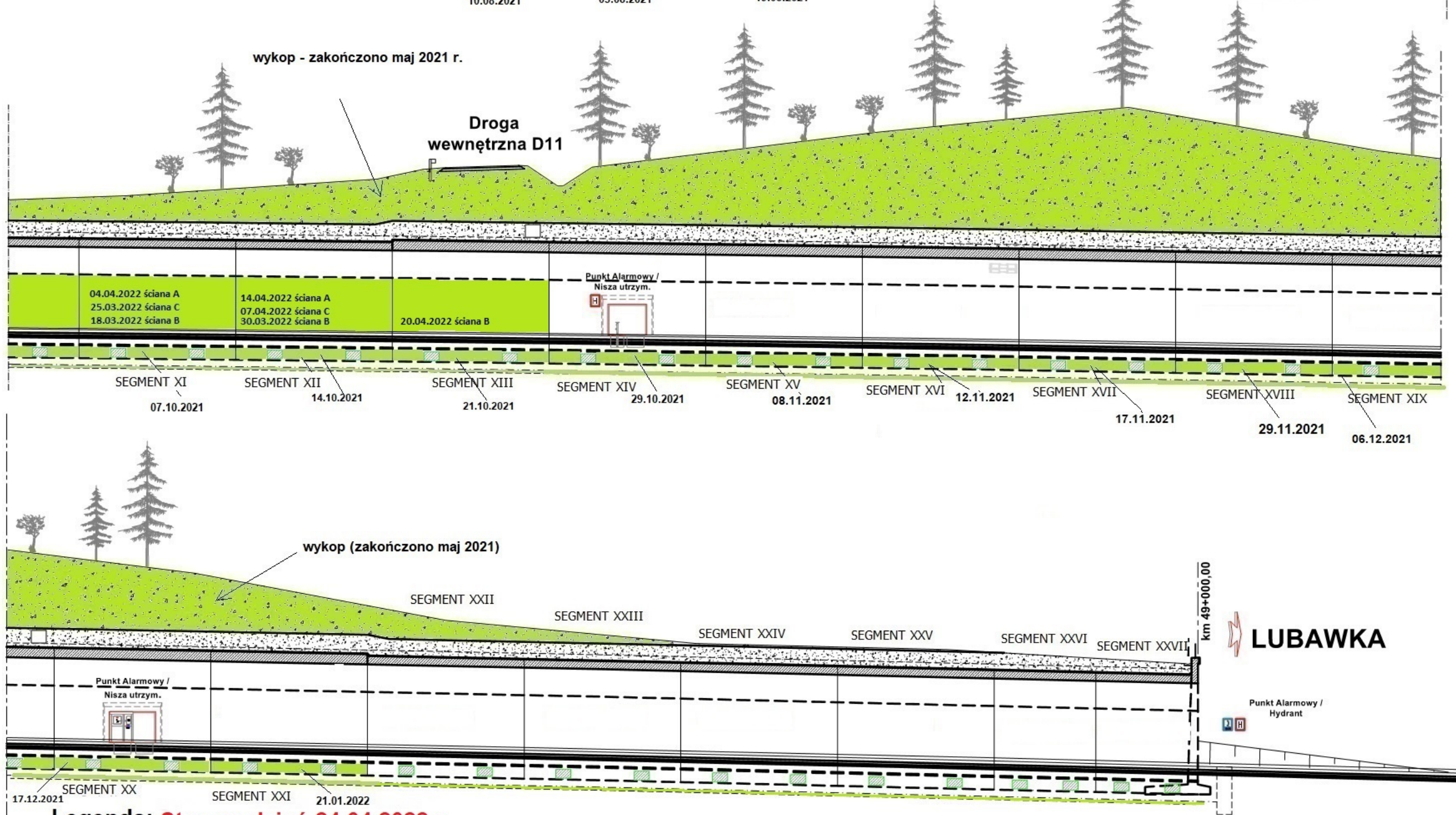
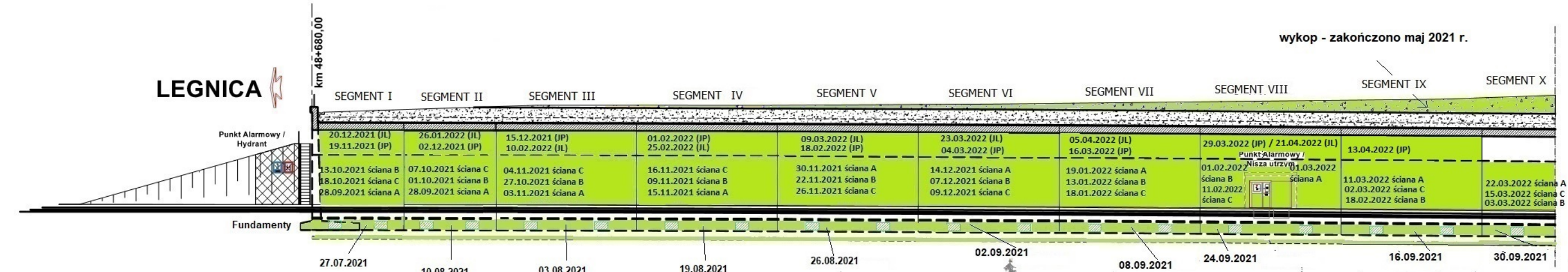

Legenda: Stan na dzień 24.04.2022 r.

- Roboty w trakcie wykonywania
- Roboty zakończone

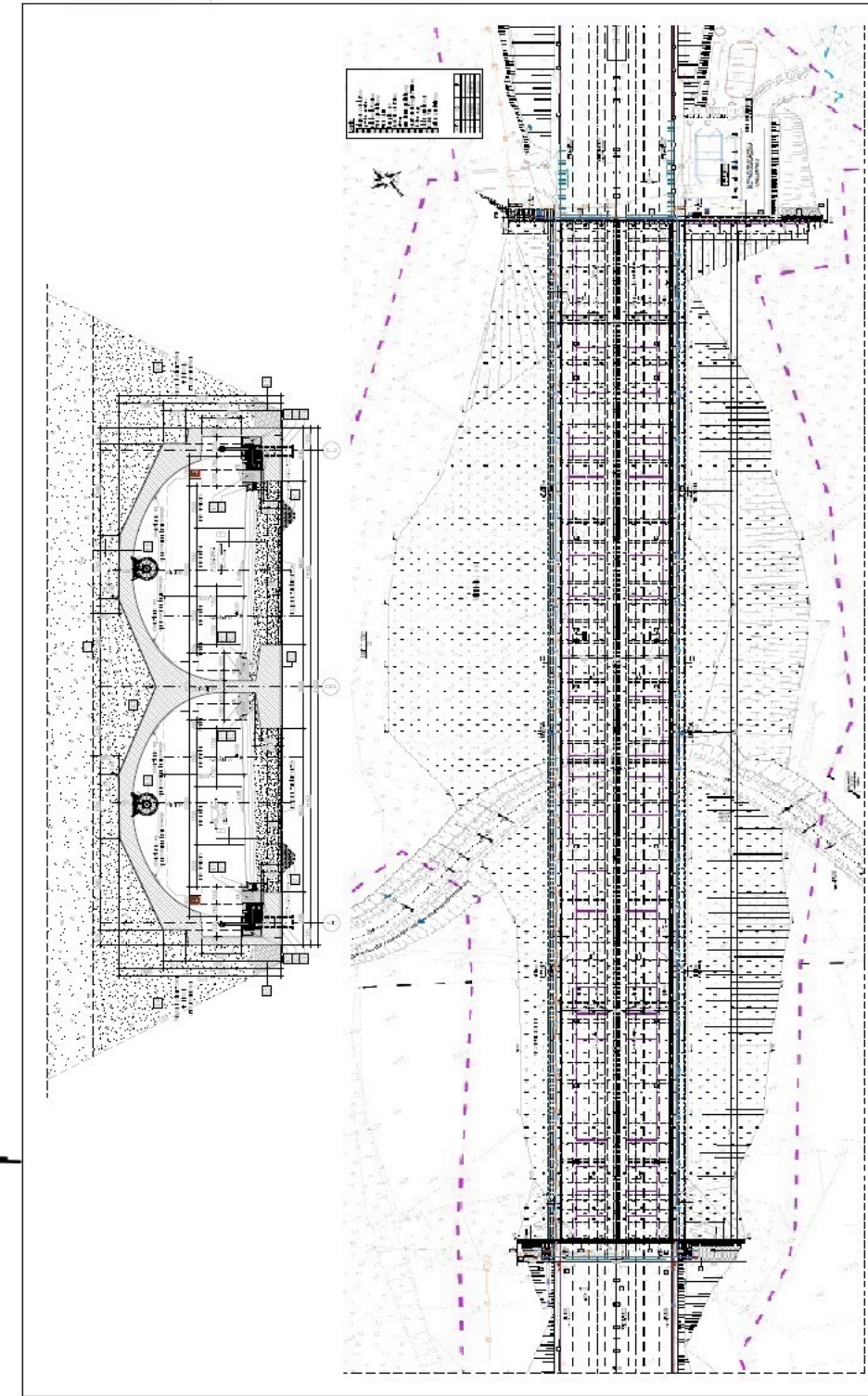

PG 10.1

km 50+097,00

← LEGNICA

LUBAWKA →

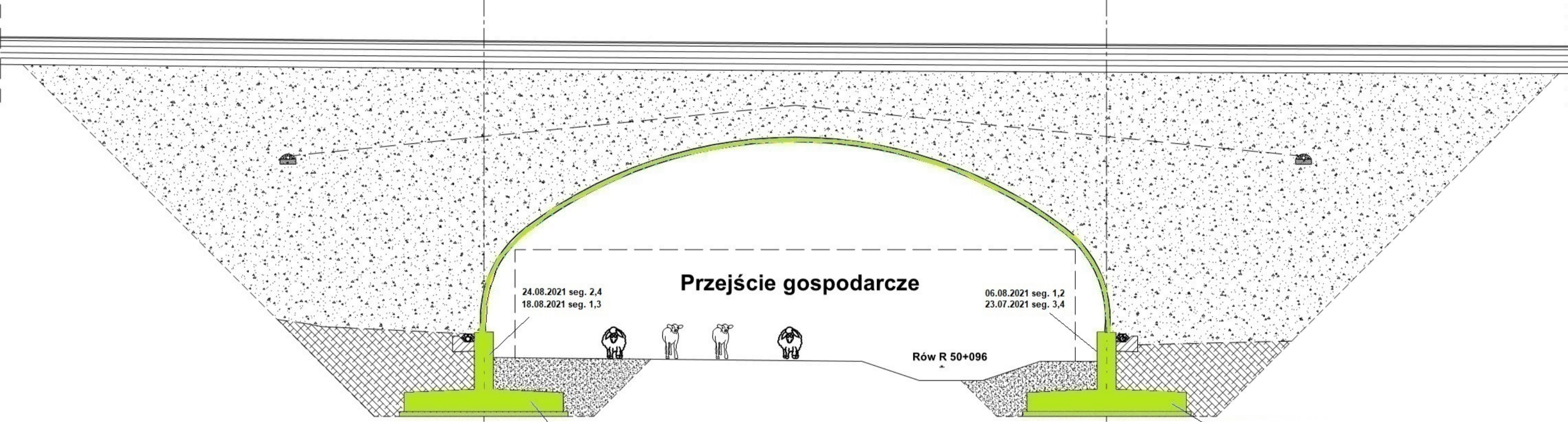

24.08.2021 seg. 2,4
18.08.2021 seg. 1,3

06.08.2021 seg. 1,2
23.07.2021 seg. 3,4

Rów R 50+096

05.07.2021 seg. 1,3
24.06.2021 seg. 2,4

08.07.2021 seg. 1,3
29.07.2021 seg. 2,4

Legenda: Stana na dzień 24.04.2022 r.

- Roboty w trakcie wykonywania
- Roboty zakończone

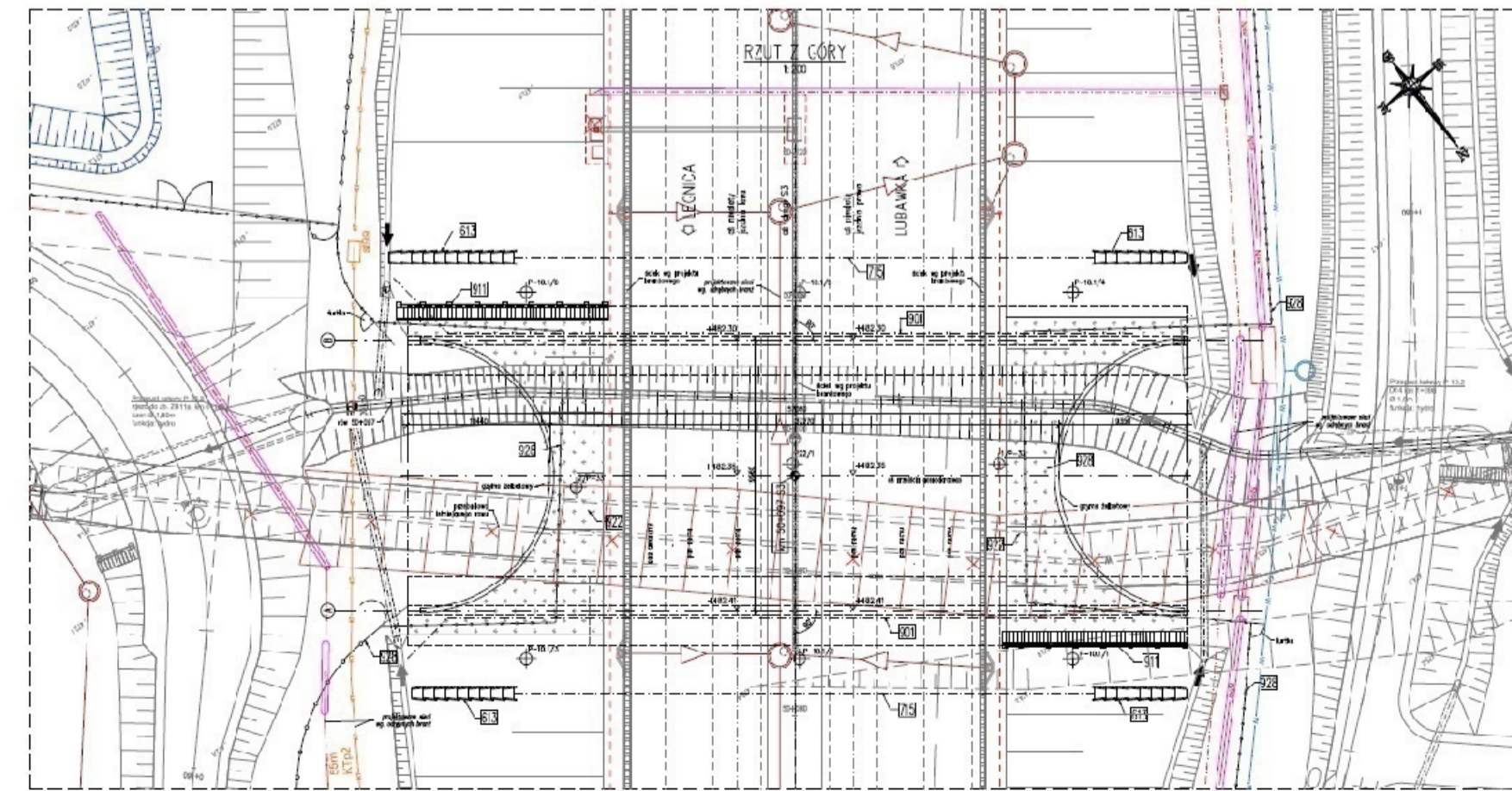
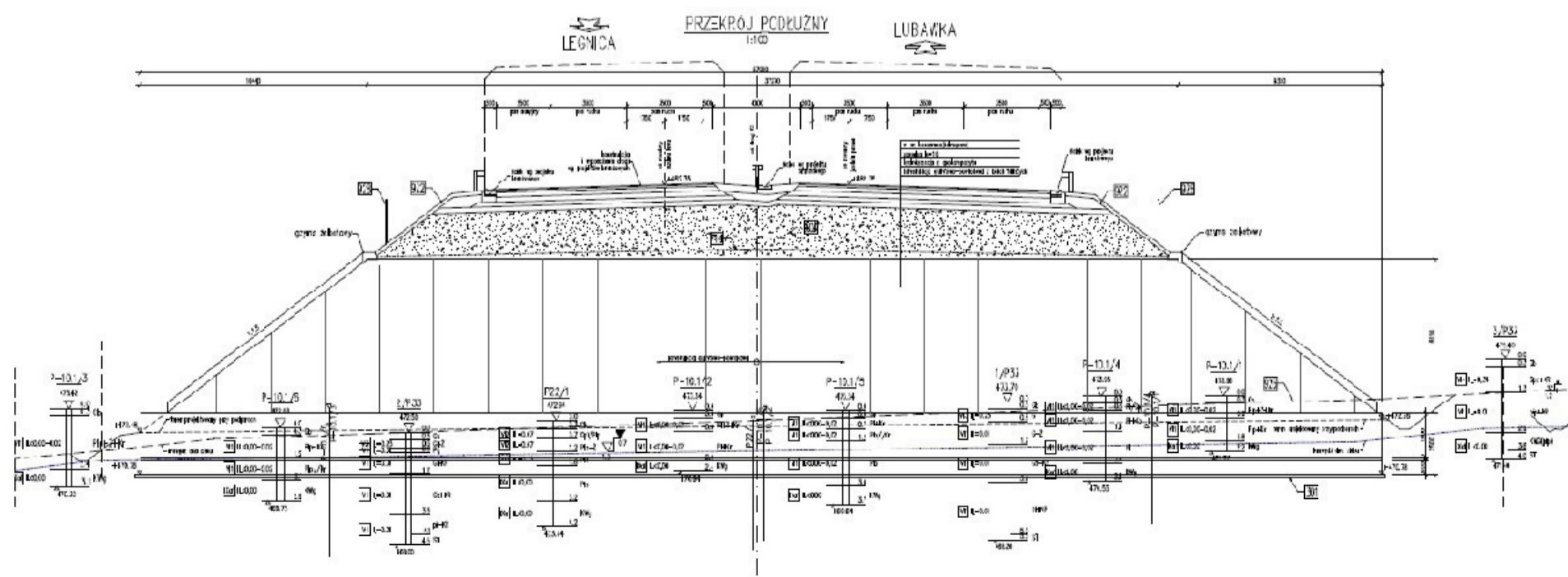

WS-33
km 49+530,70

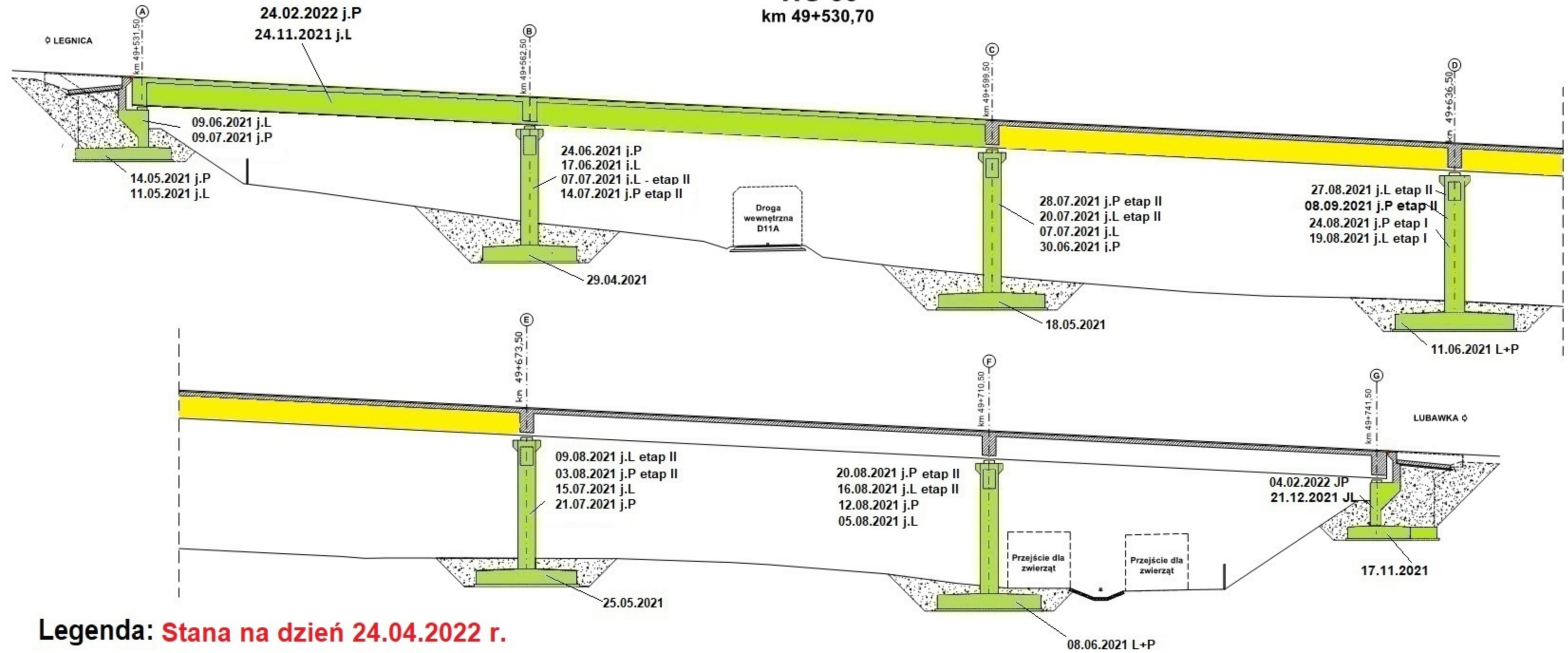

Legenda: Stana na dzień 24.04.2022 r.

- Roboty w trakcie wykonywania
- Roboty zakończone

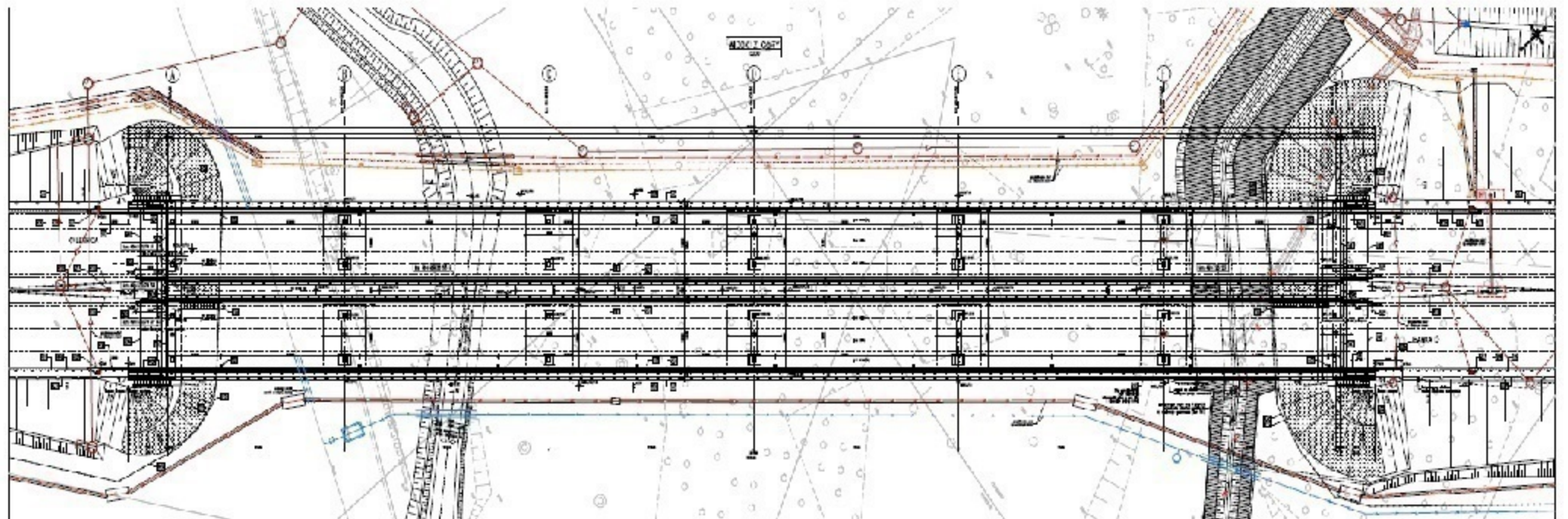
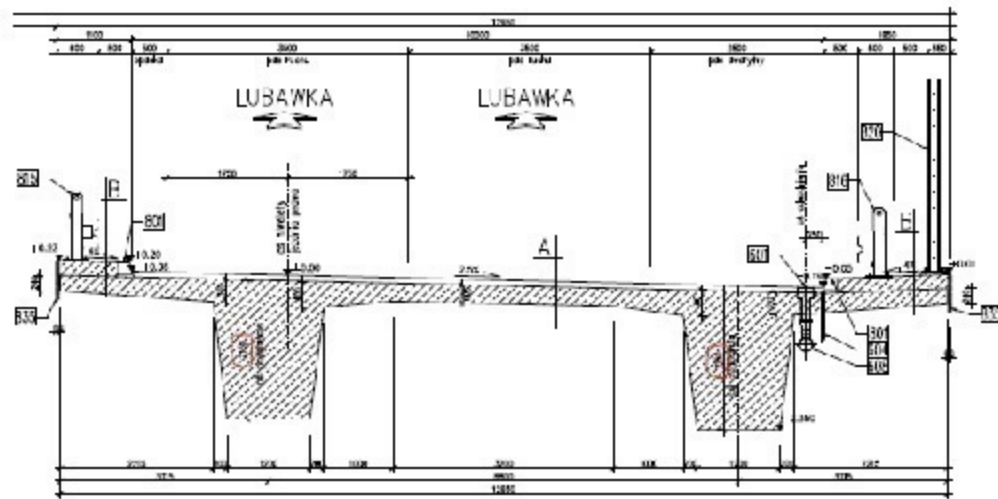

WD-34

km 50+661,15

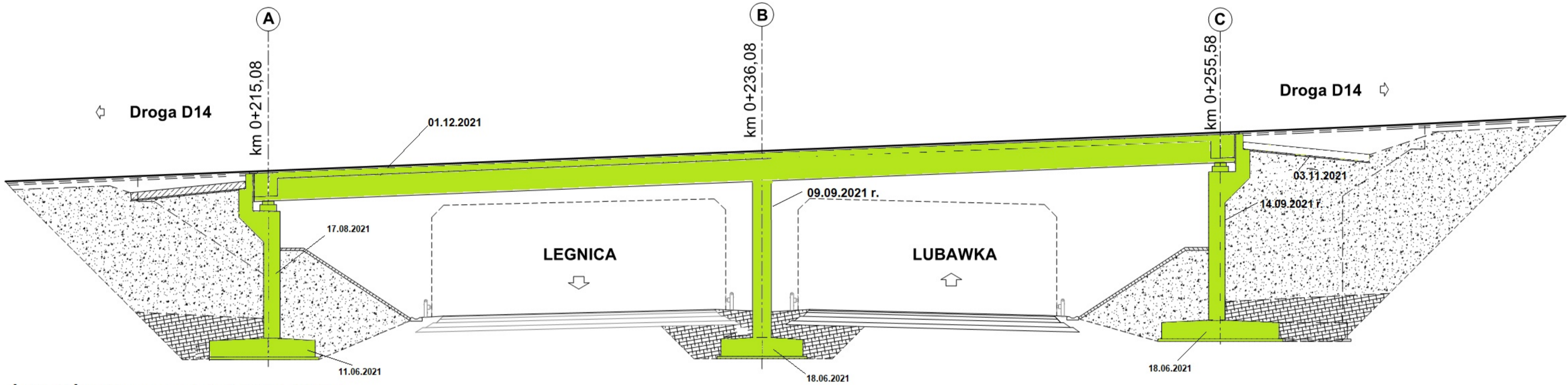

Legenda: Stana na dzień 24.04.2022 r.

- Roboty w trakcie wykonywania
- Roboty zakończone

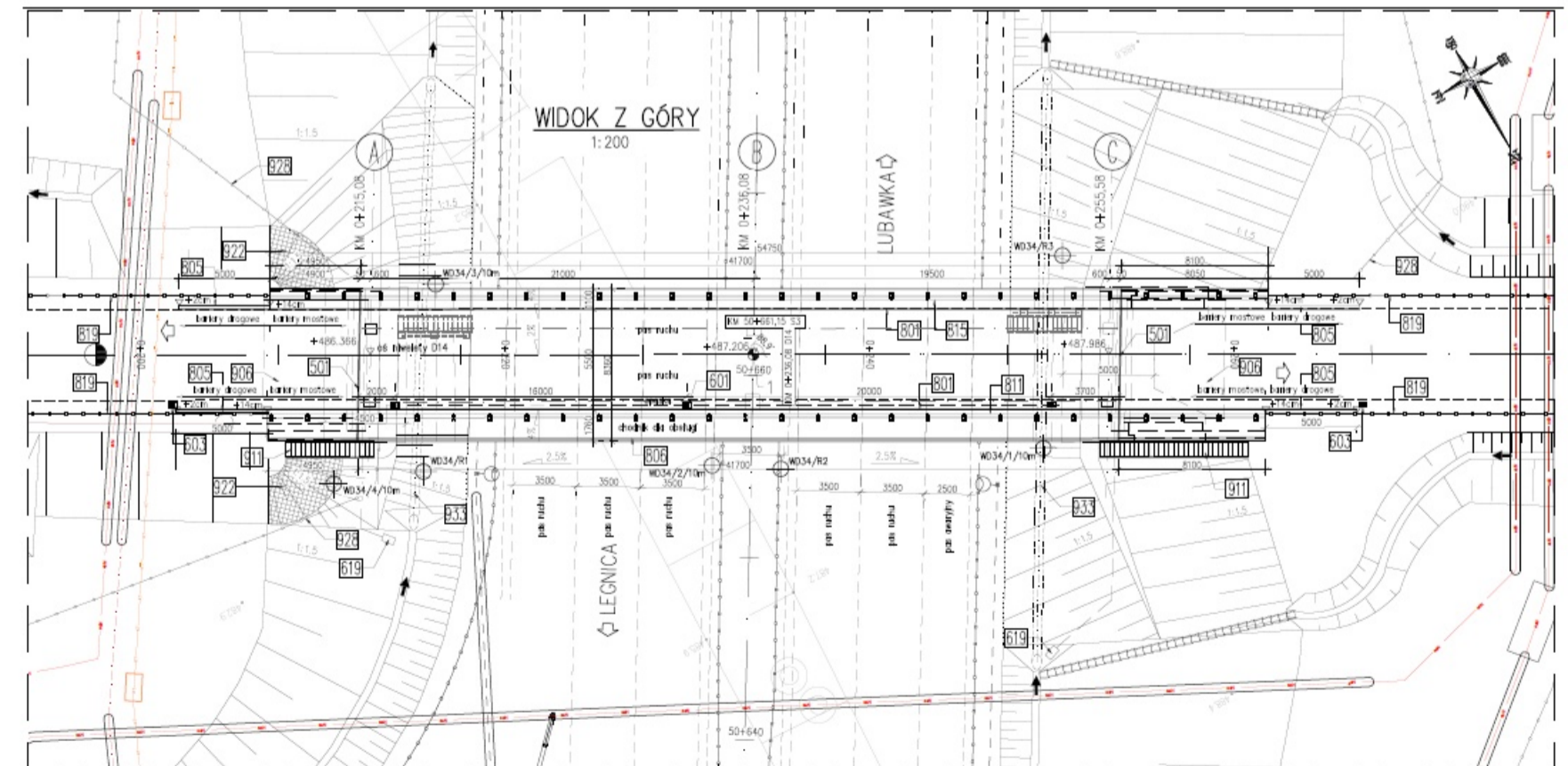
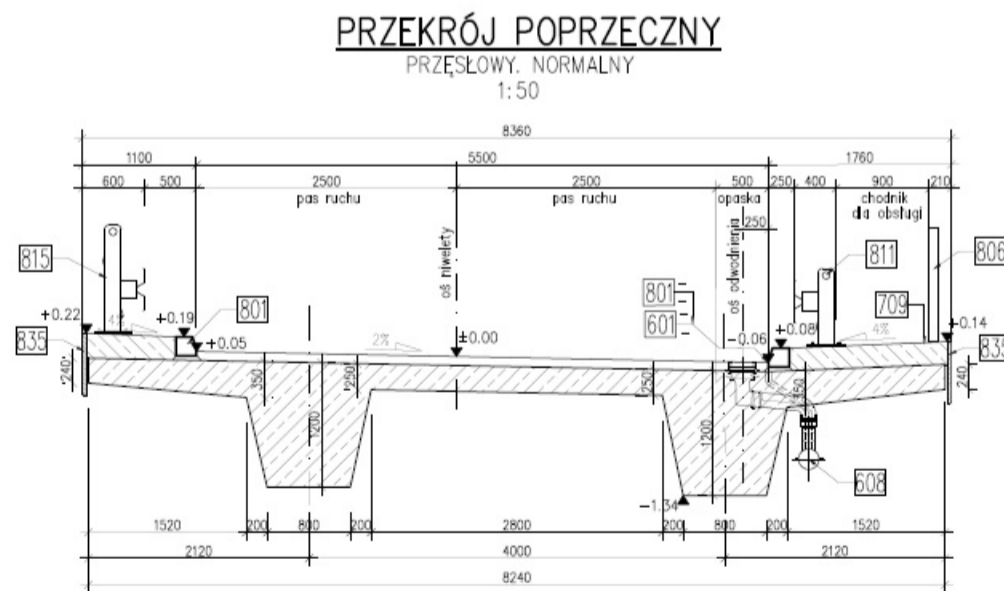

PG 11.1

km 51+249,00

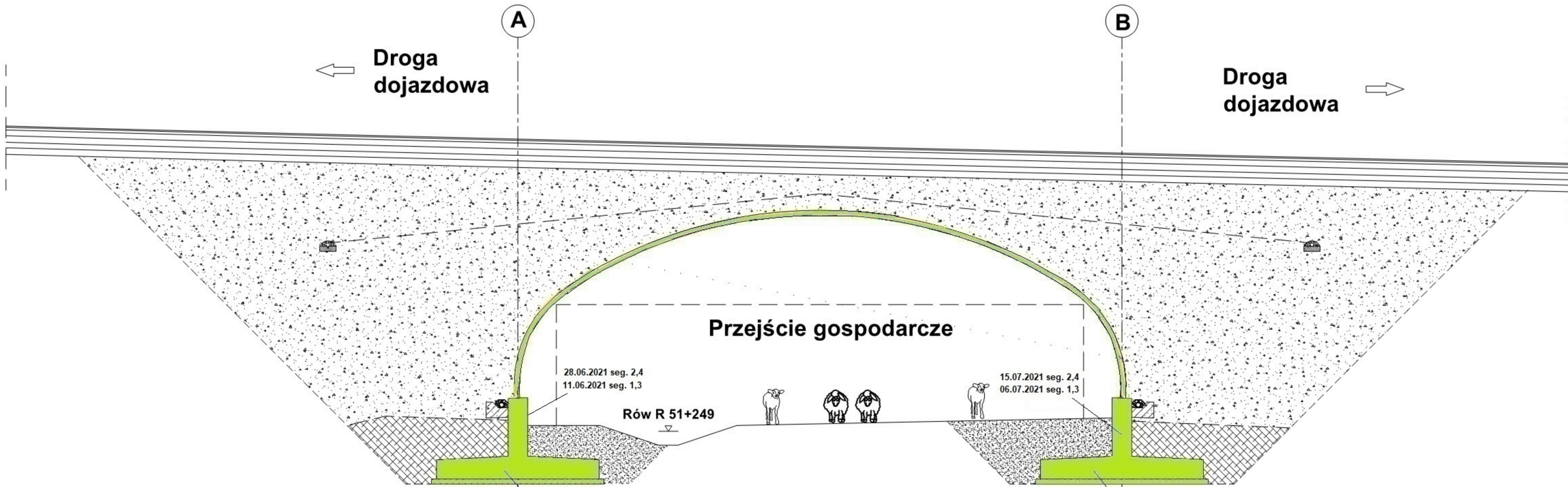

Legenda: **Stana na dzień 24.04.2022 r.**

- Roboty w trakcie wykonywania
- Roboty zakończone

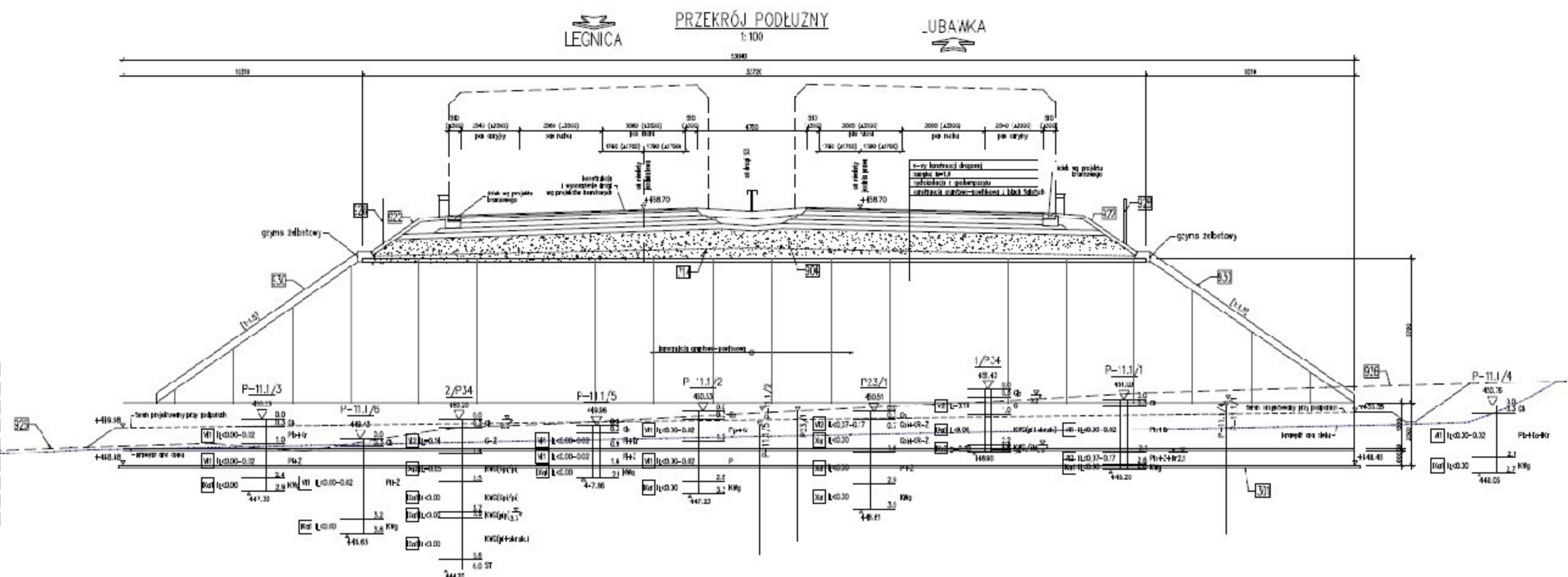

WS-35

km 51+508,81

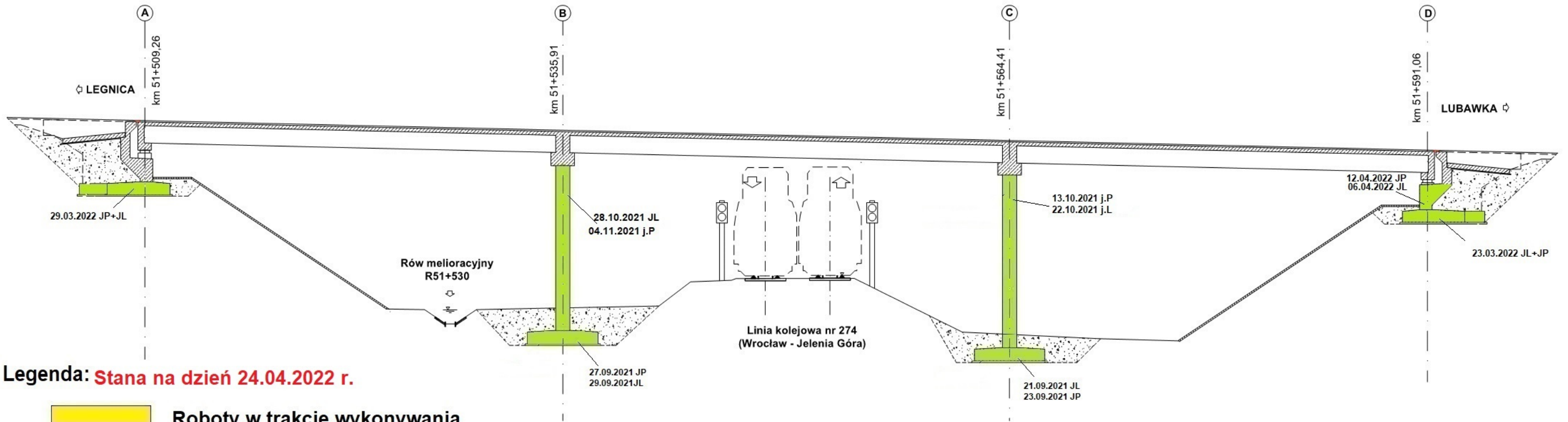

Legenda: Stana na dzień 24.04.2022 r.

- Roboty w trakcie wykonywania
- Roboty zakończone

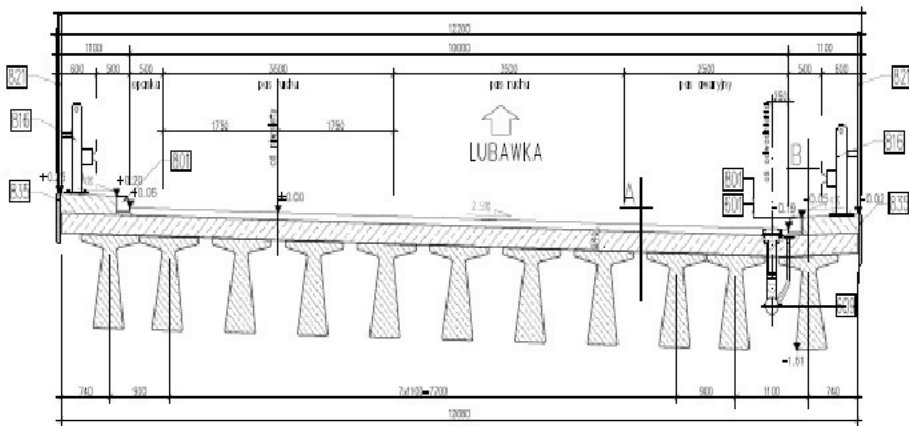

WS-36

km 51+780,95

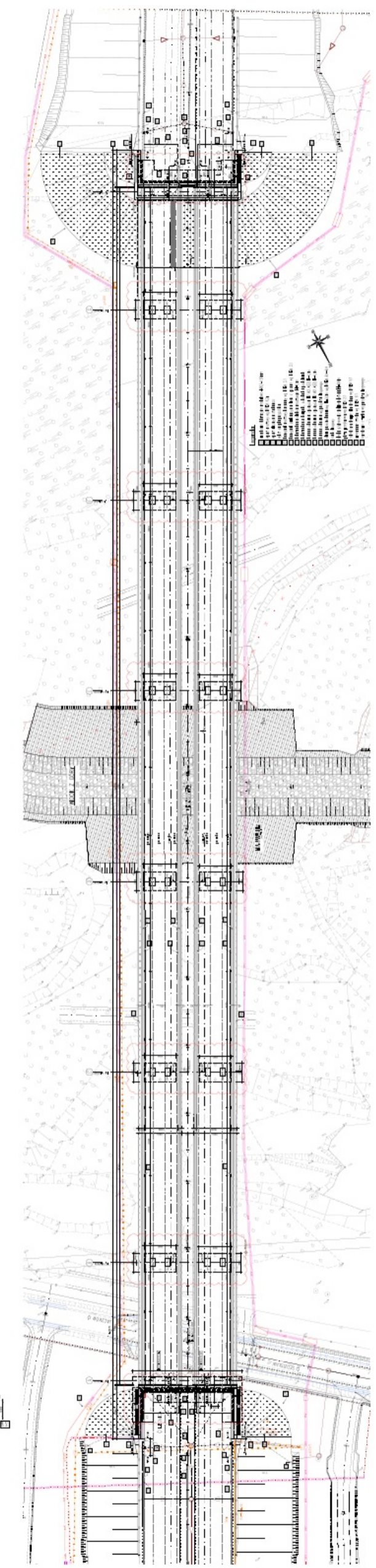
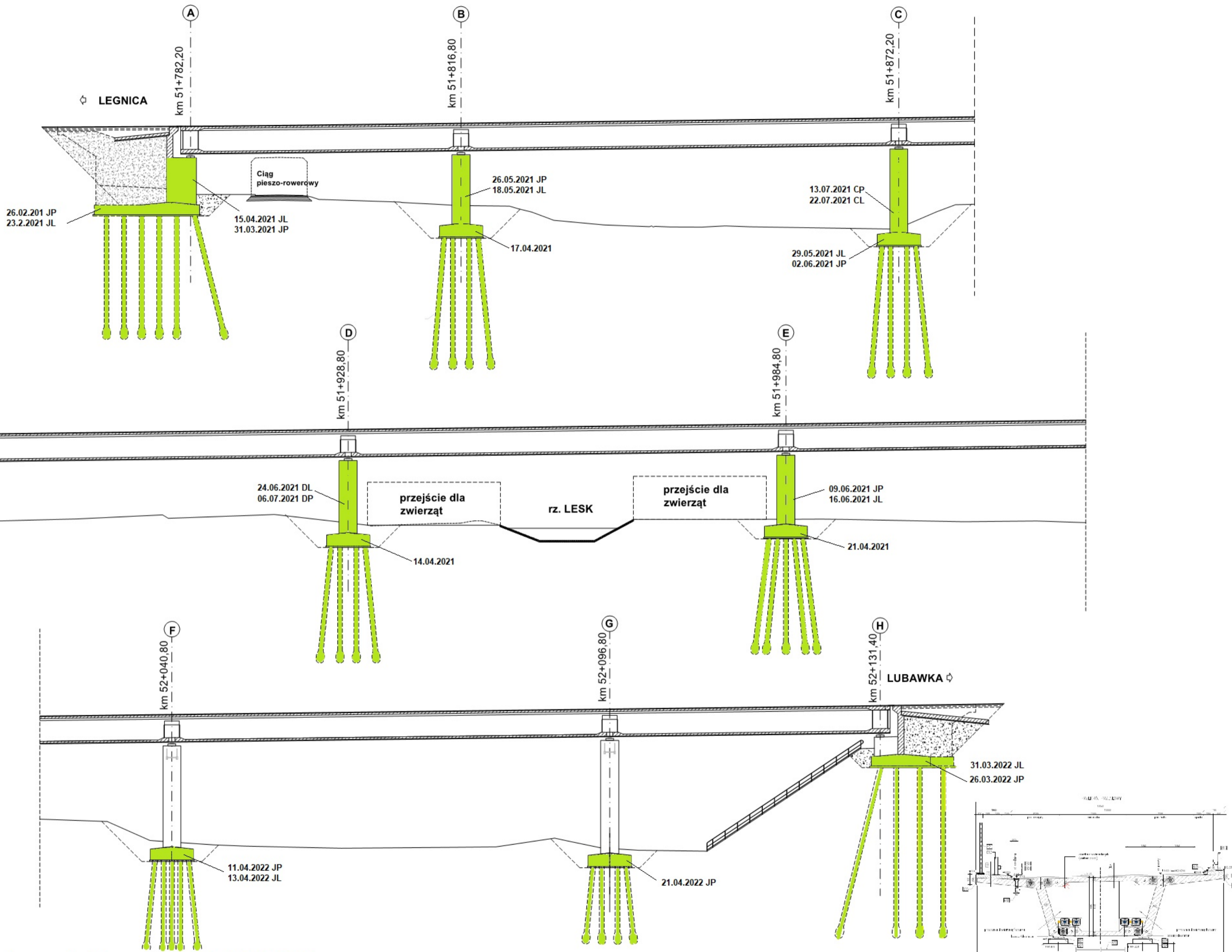

Legenda: Stana na dzień 24.04.2022 r.

- Roboty w trakcie wykonywania
- Roboty zakończone

WS-37

km 52+994,25

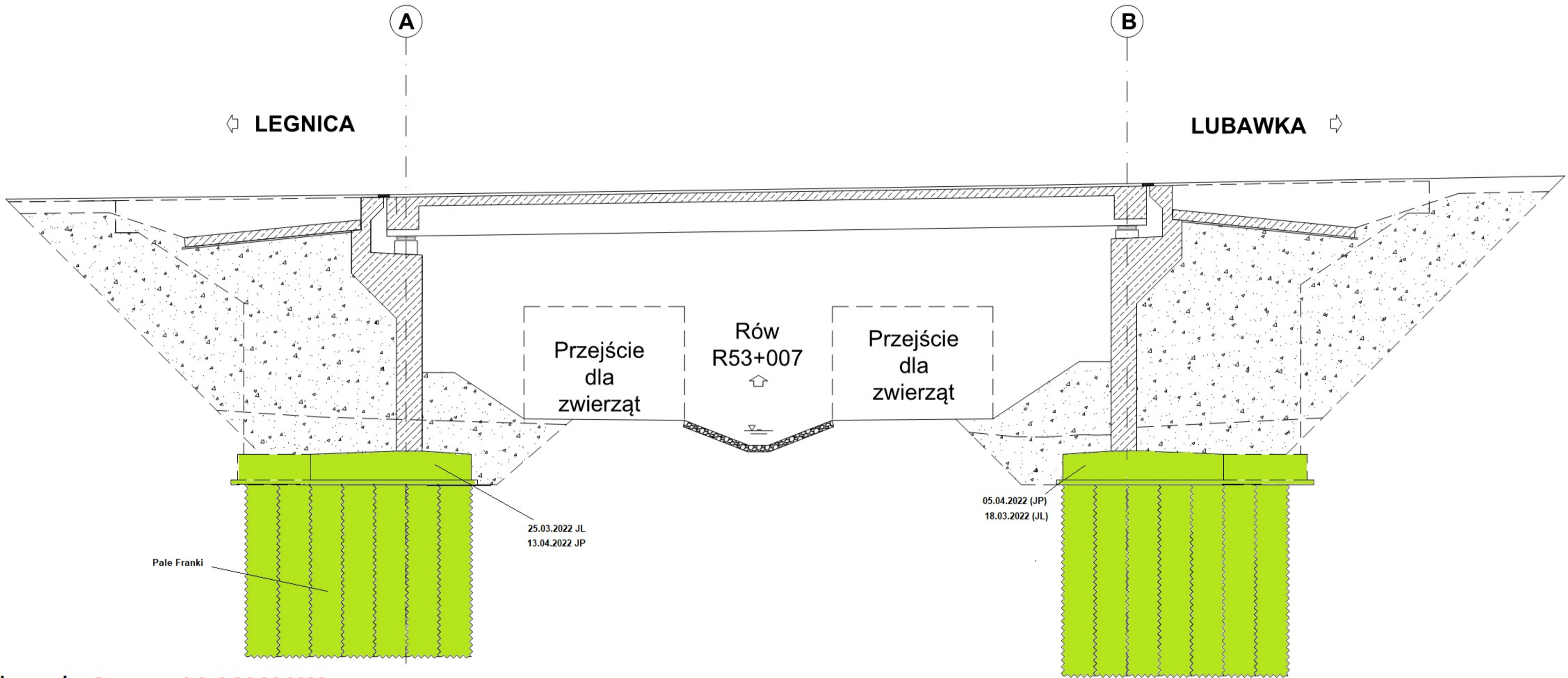

Legenda: **Stana na dzień 24.04.2022 r.**

- Roboty w trakcie wykonywania
- Roboty zakończone

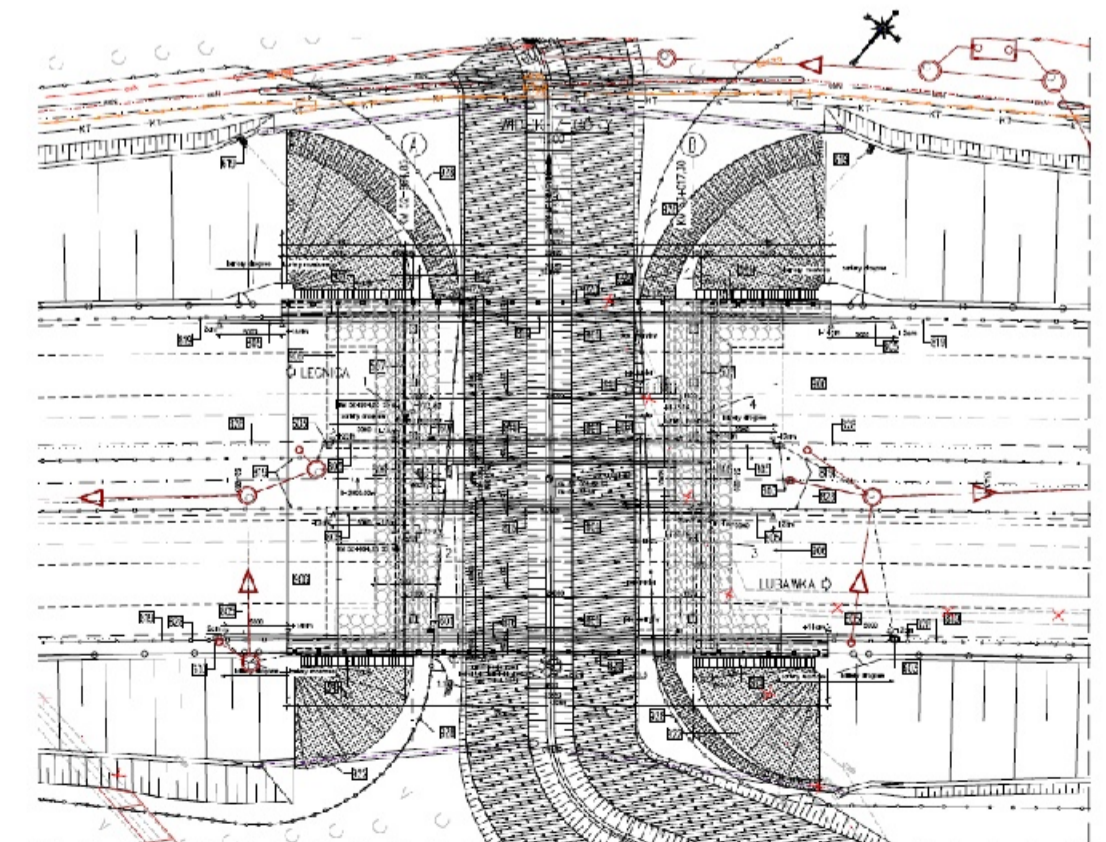
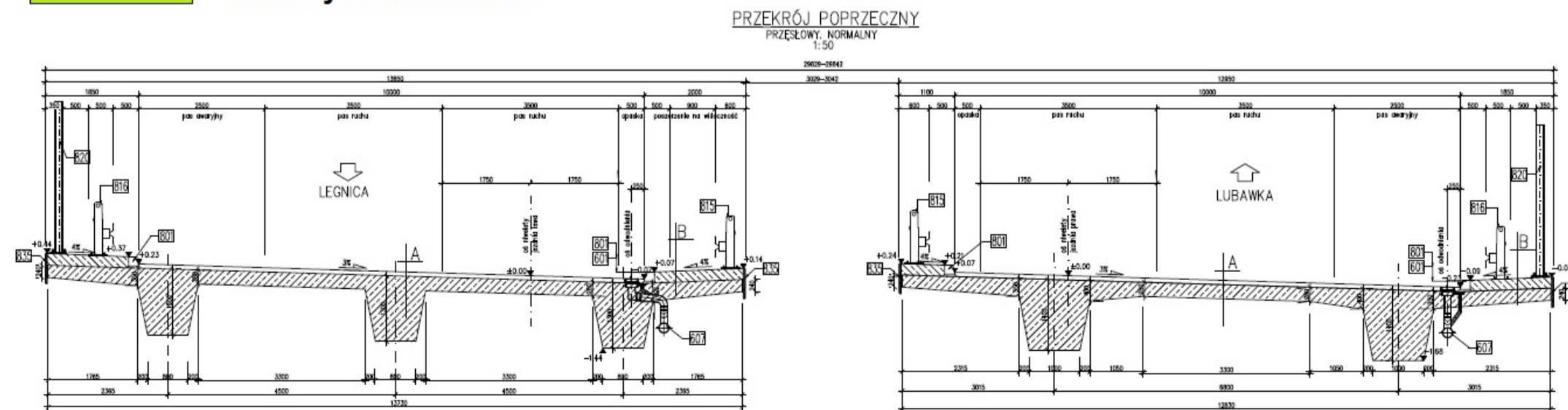

WD-38

km 53+798,79

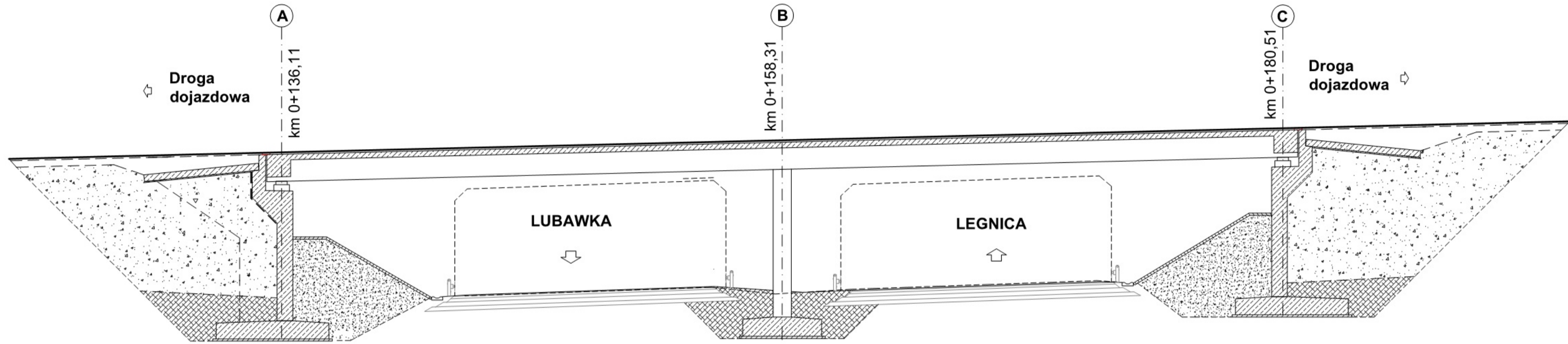

Legenda: Stana na dzień 24.04.2022 r.

- Roboty w trakcie wykonywania
- Roboty zakończone

PRZEKRÓJ POPRZECZNY
PRZESŁOWY, NORMATYWNY
1:30

