

WD-22

km 38+491,21

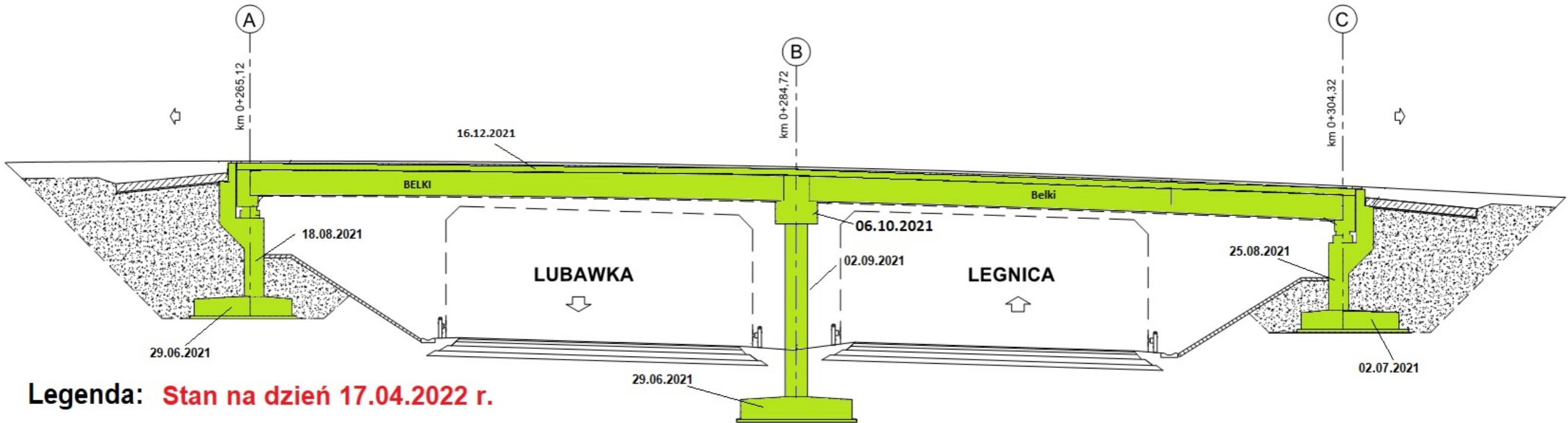

Legenda: **Stan na dzień 17.04.2022 r.**

-  Roboty w trakcie wykonywania
-  Roboty zakończone

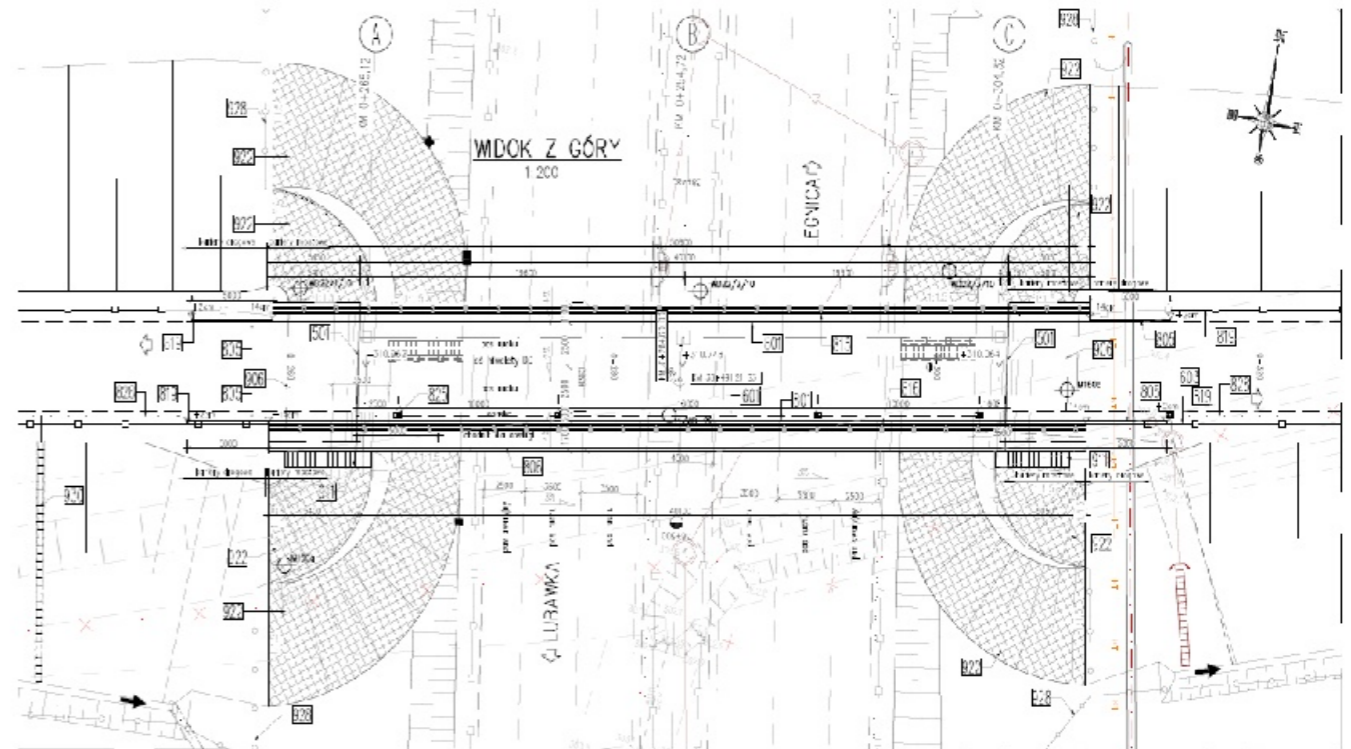
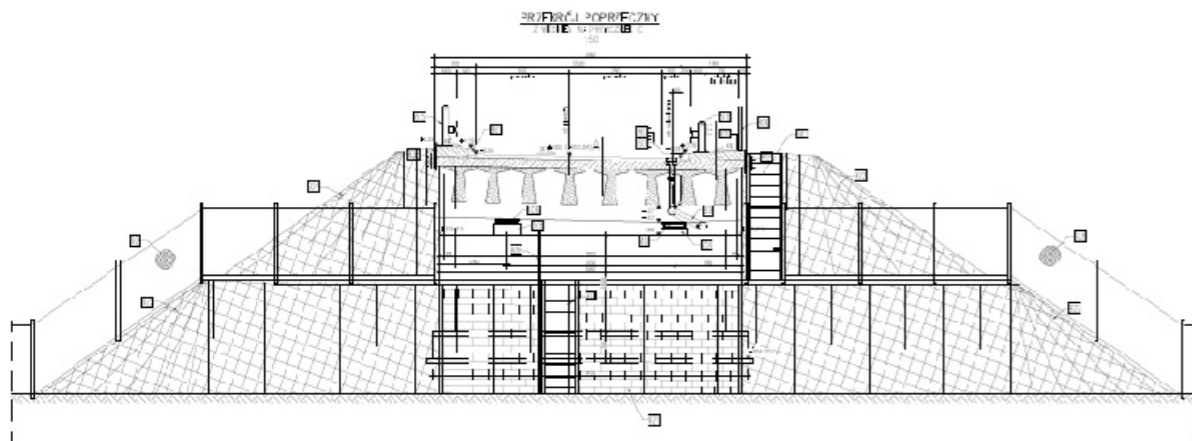

WS-24

km 41+431,41

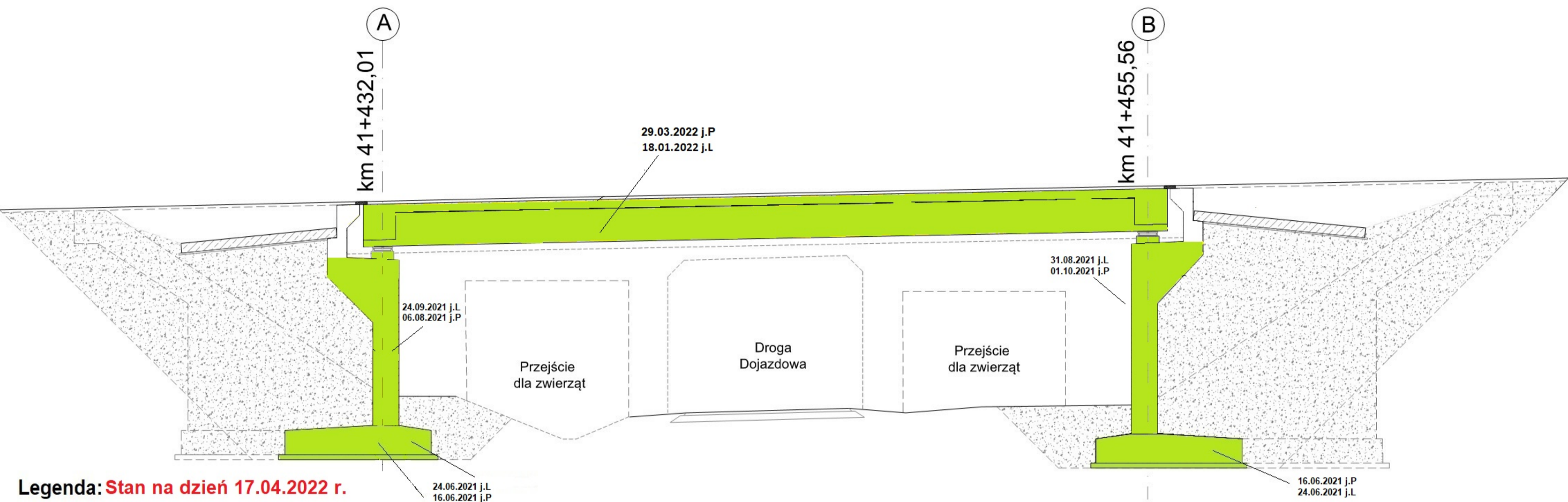

Legenda: Stan na dzień 17.04.2022 r.

- Roboty w trakcie wykonywania
- Roboty zakończone

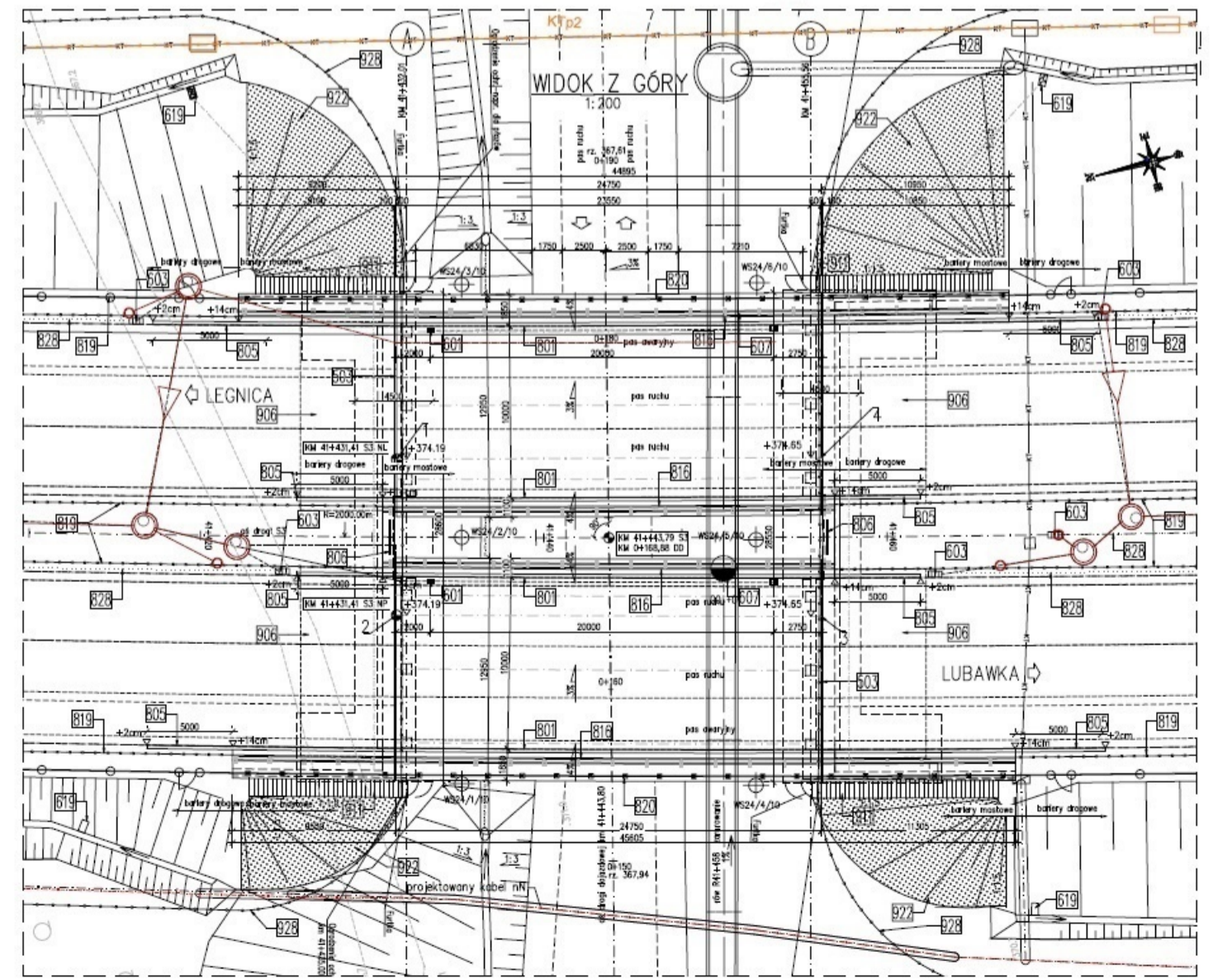
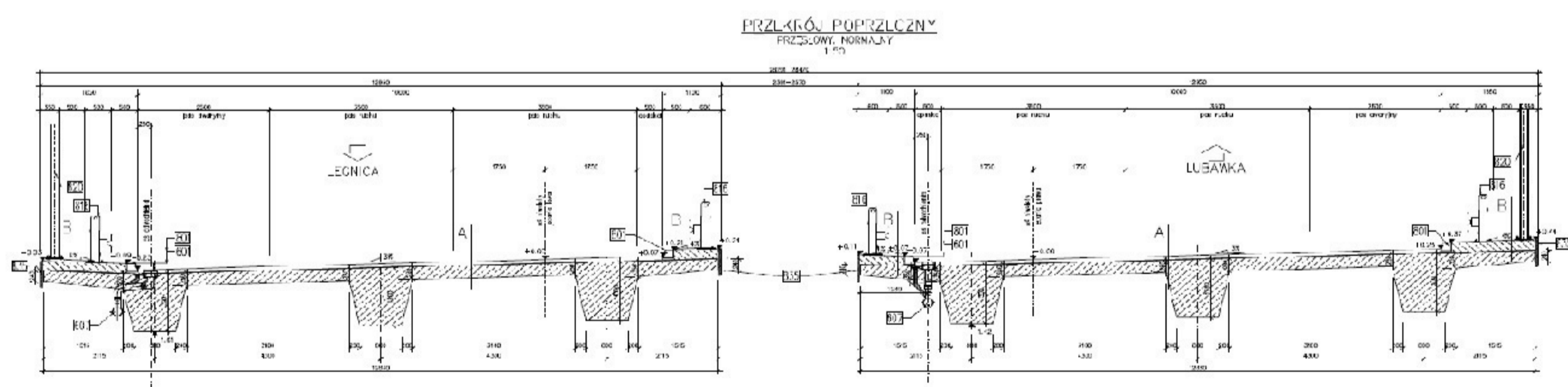

MS-25

km 41+996,65

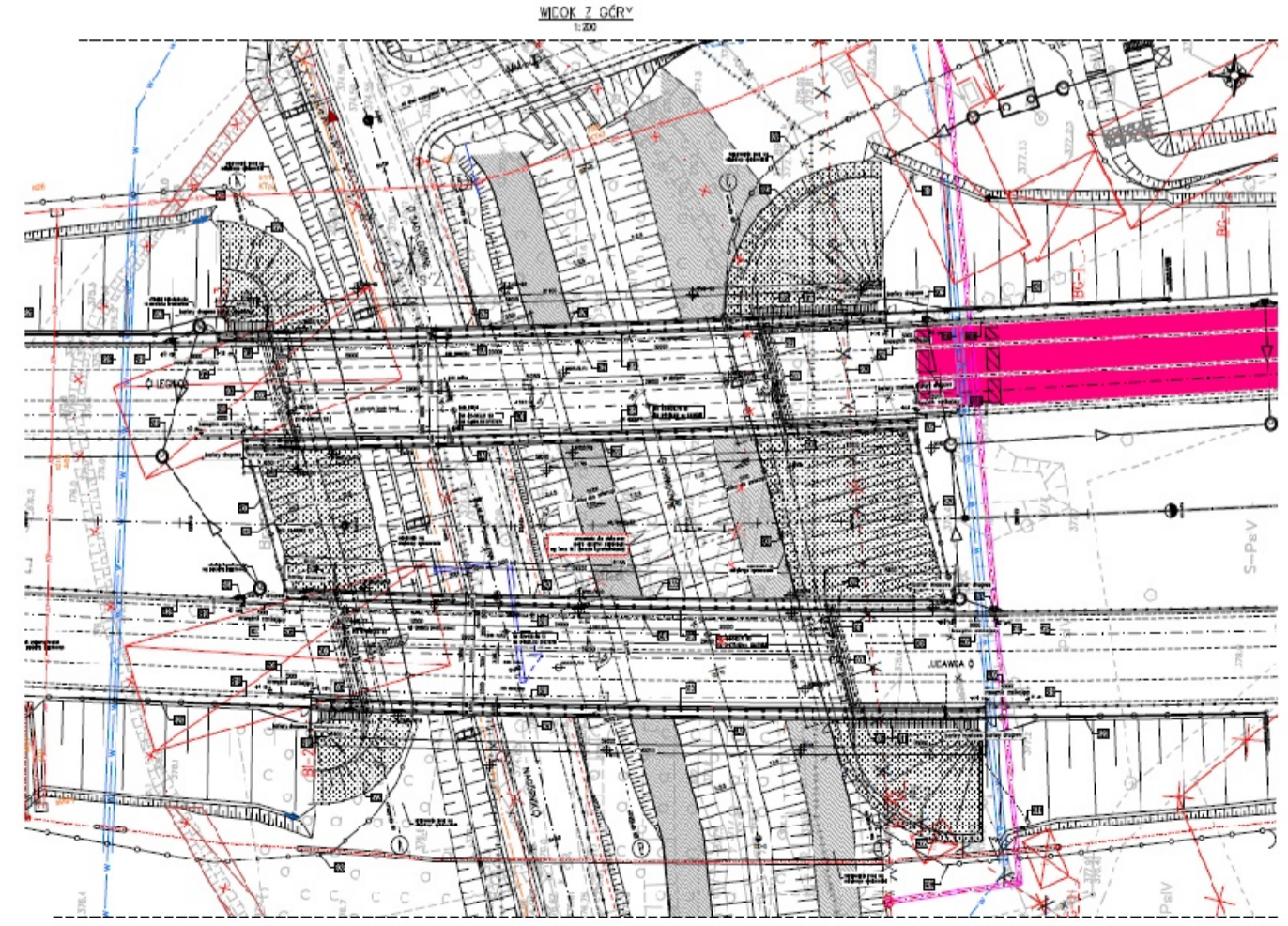
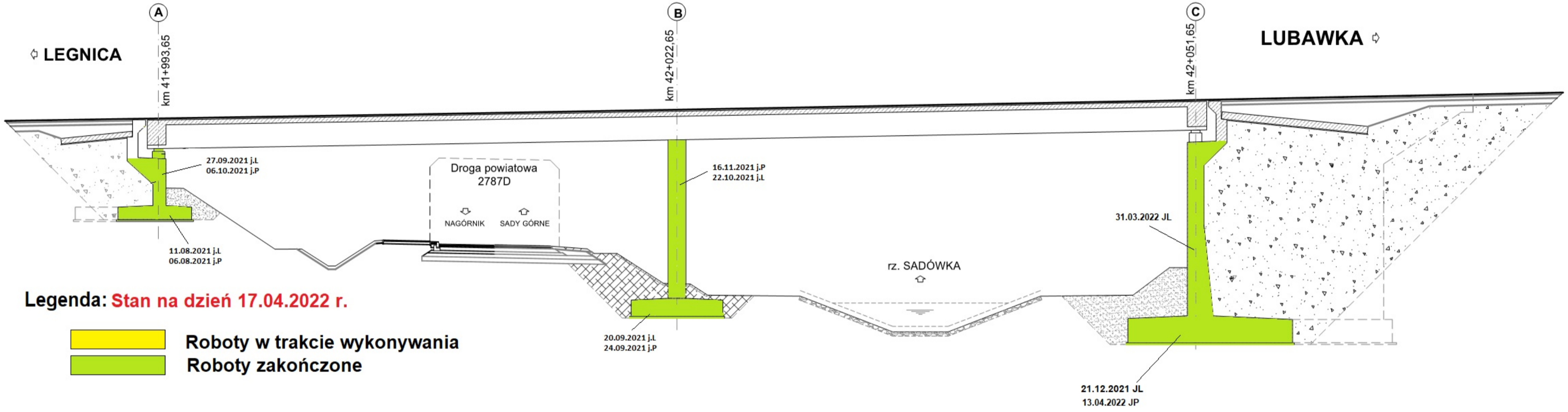

WD-27

km 44+702,77

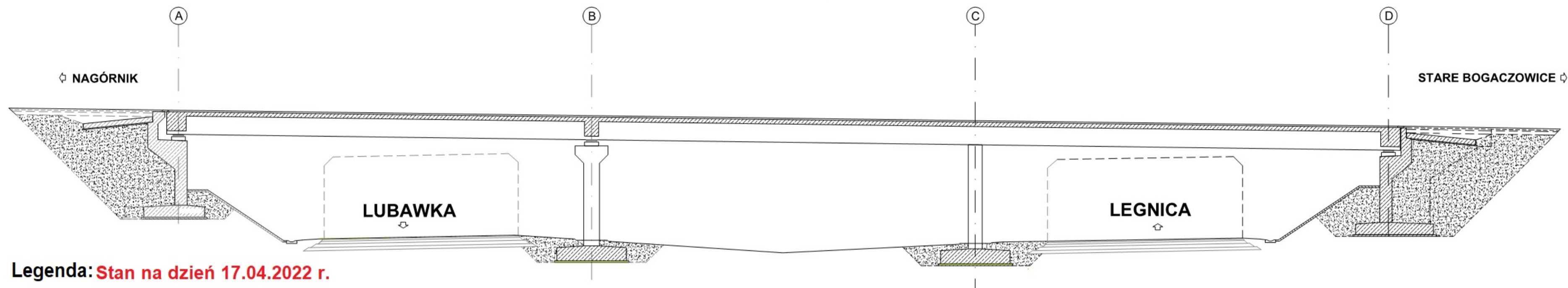

Legenda: Stan na dzień 17.04.2022 r.

- Roboty w trakcie wykonywania
- Roboty zakończone

PRZEKRÓJ POPRZECZNY
Z WIDOKIEM NA FILAR
1:50

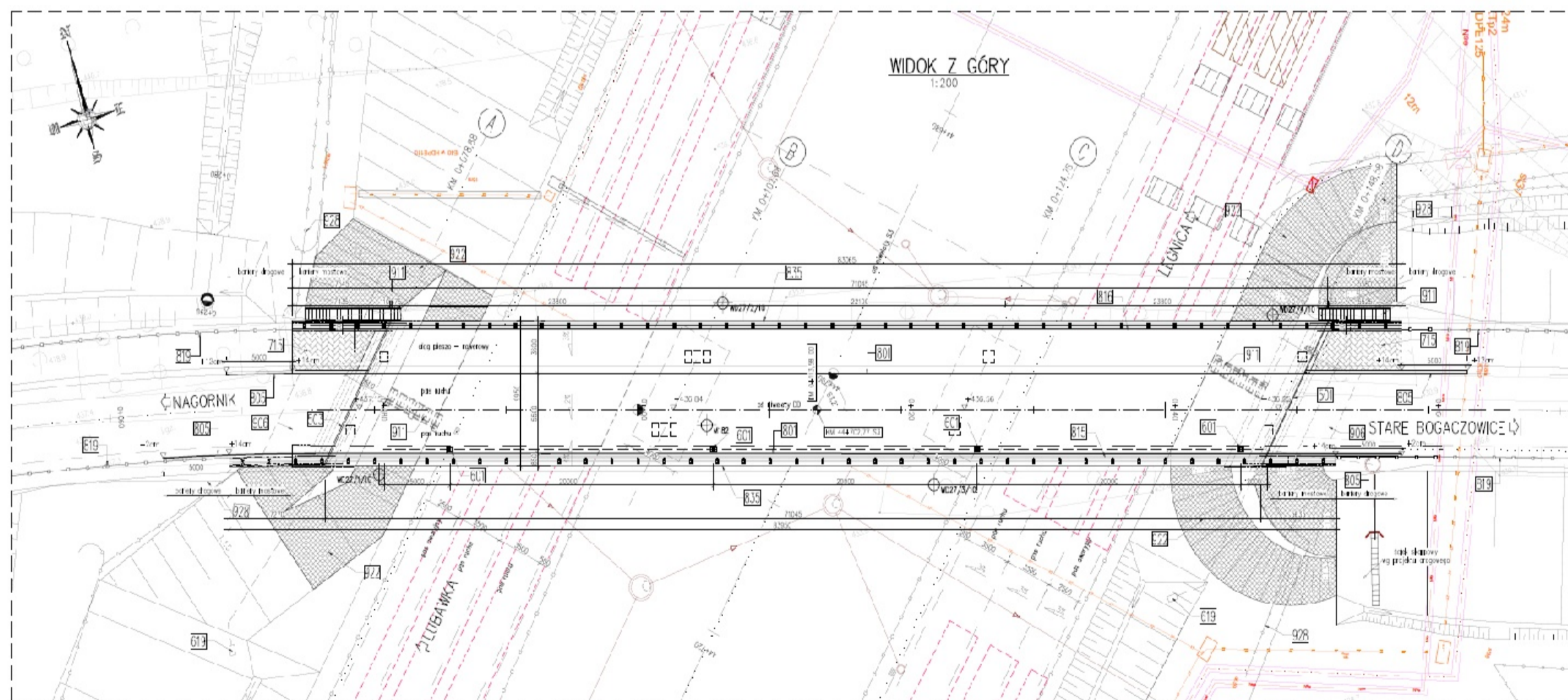
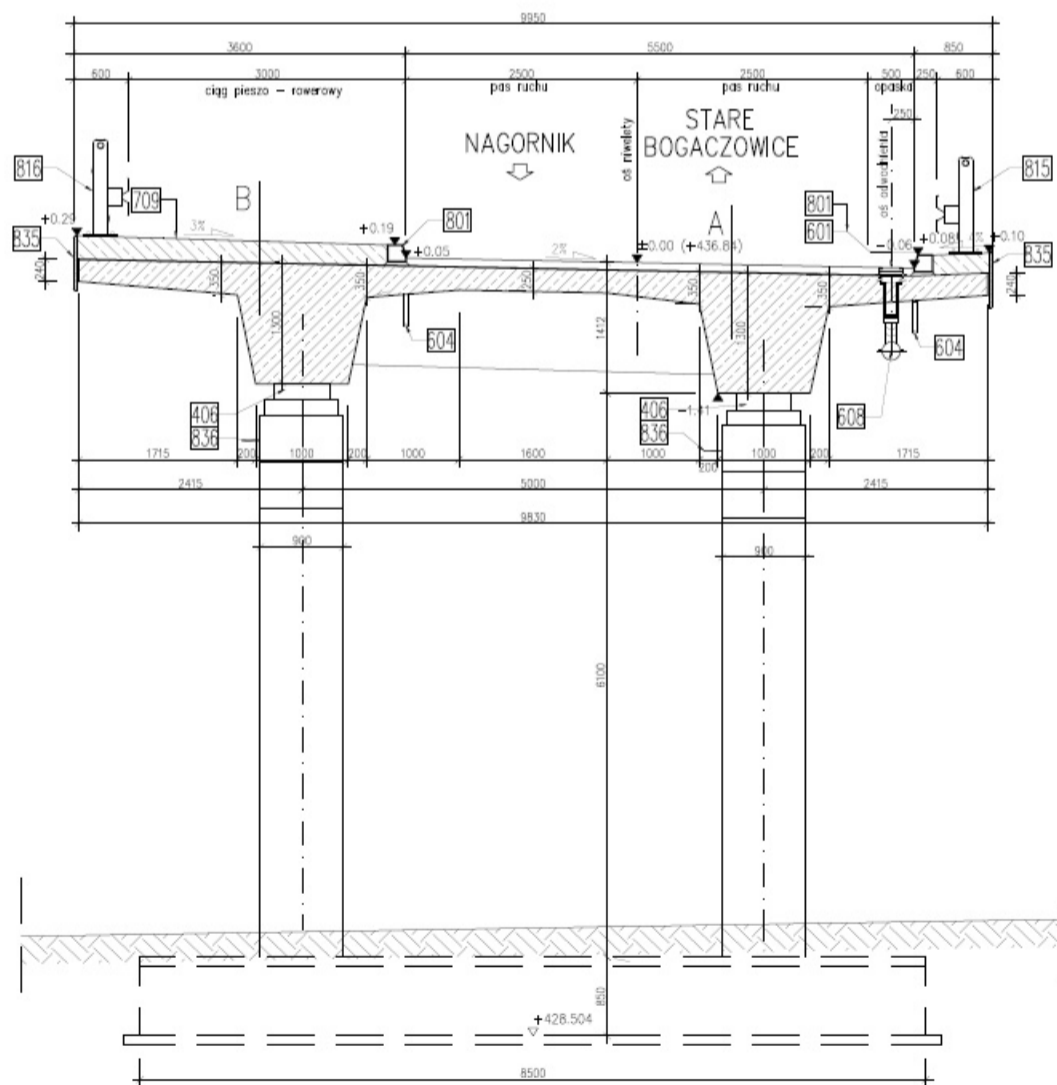

PG-29

km 46+743,46

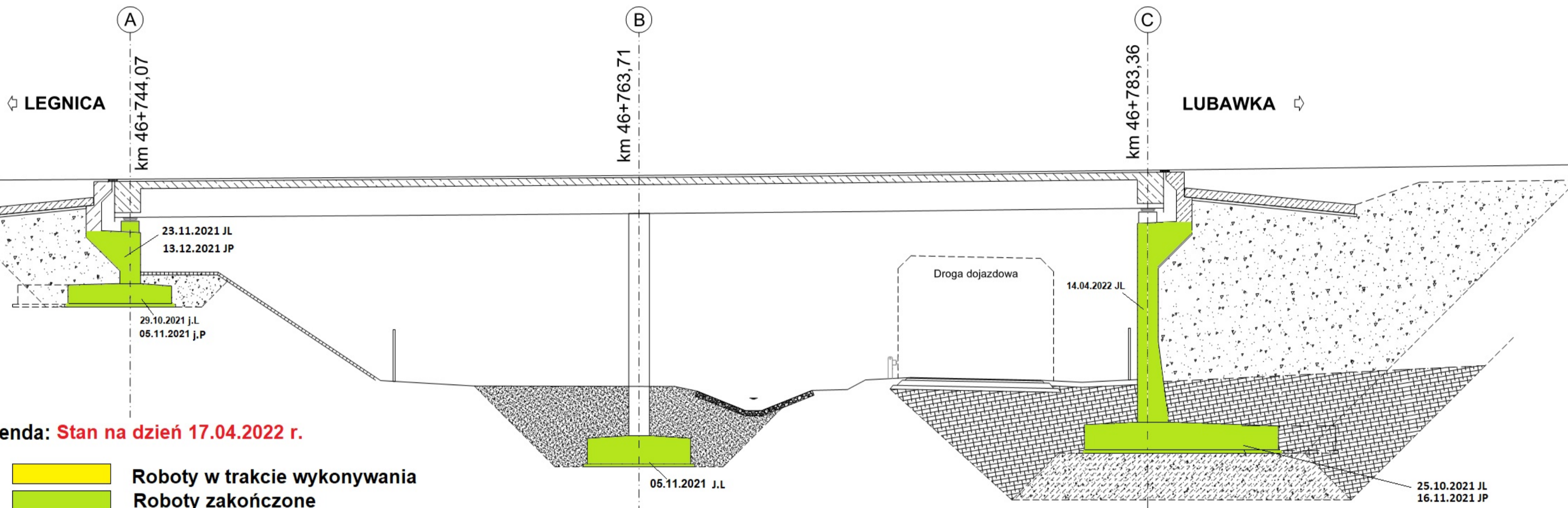

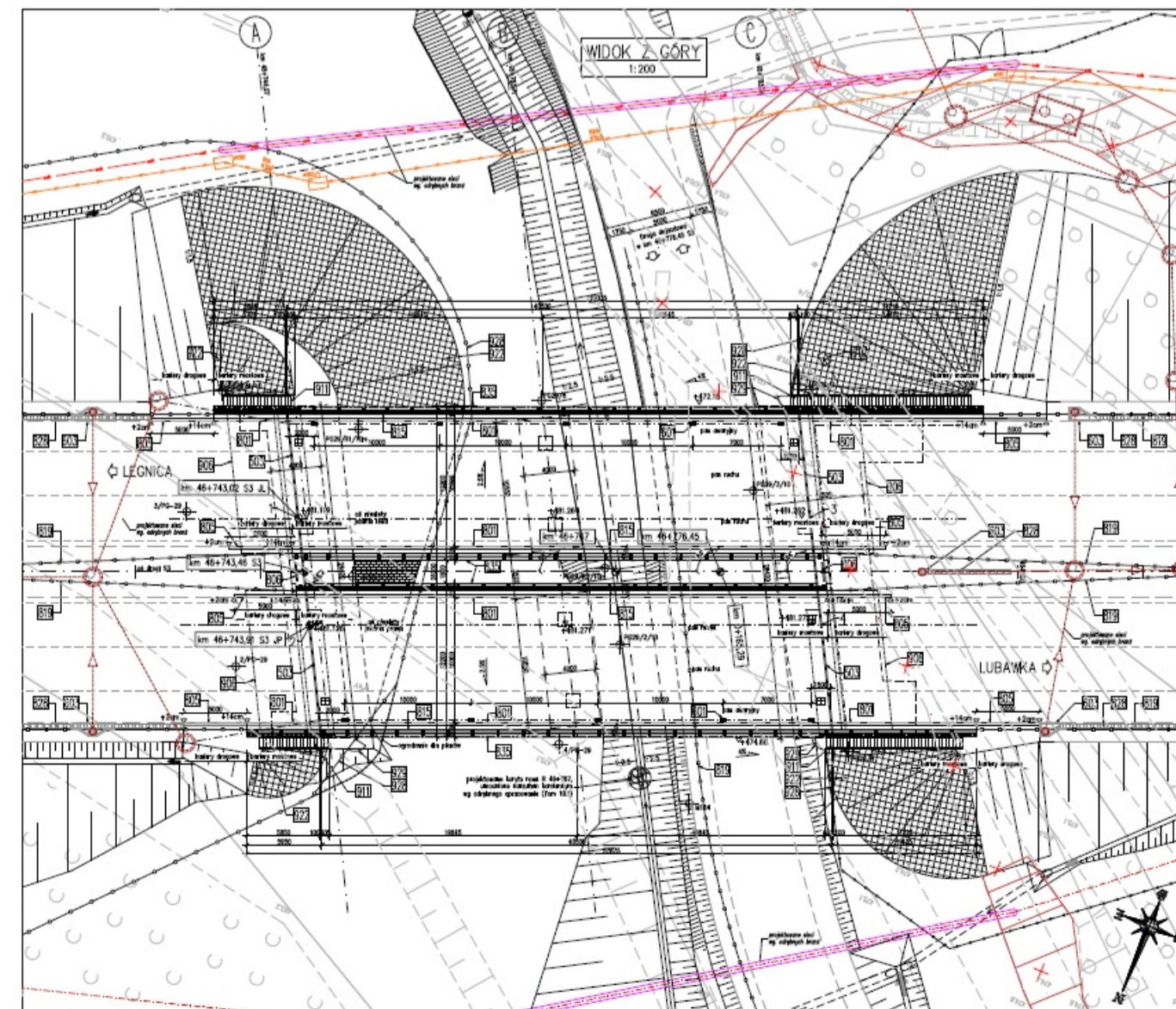
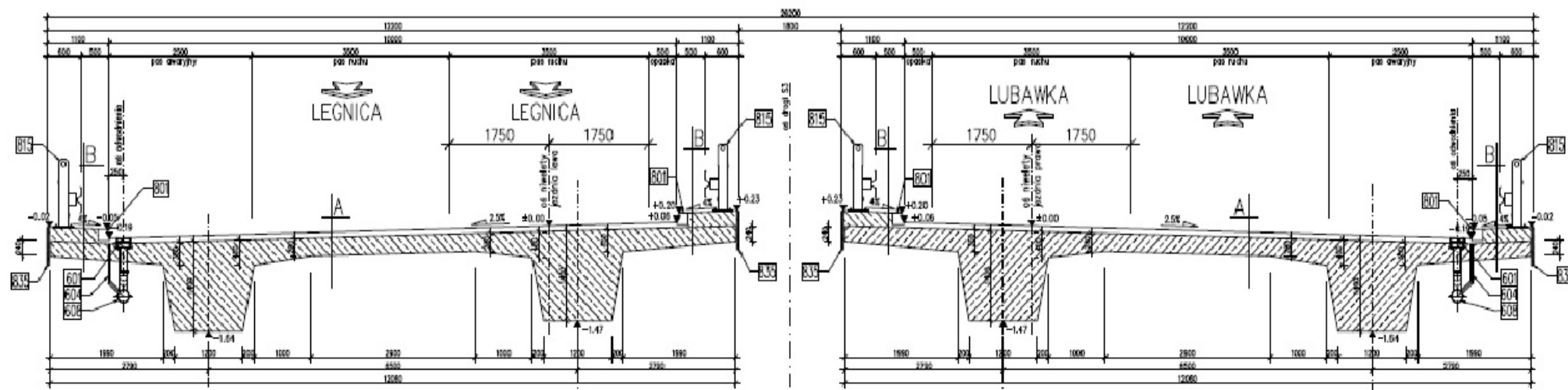

PRZEKRÓJ POPRZECZNY
PRZEŚLÓWY NORMALNY
1:50



WS-30

km 46+908.42

Legenda: Stan na dzień 17.04.2022 r.

-  Roboty w trakcie wykonywania
-  Roboty zakończone

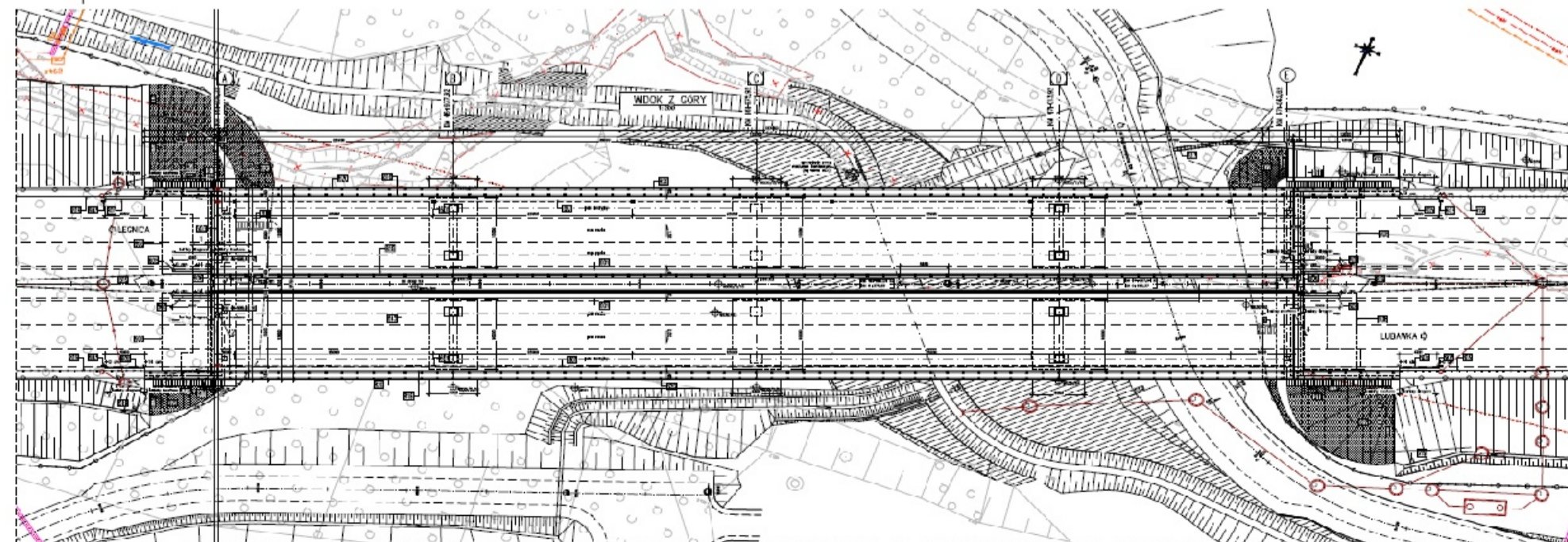
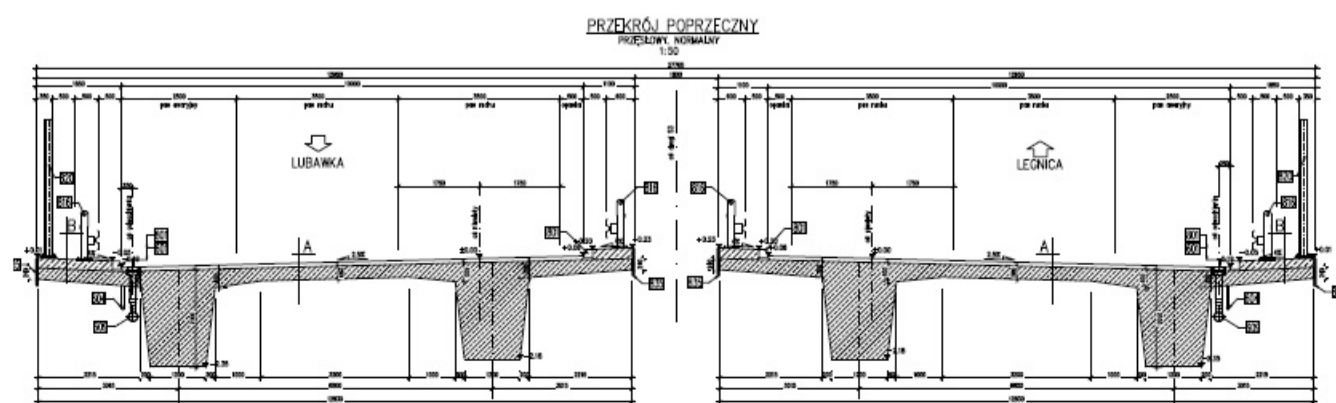
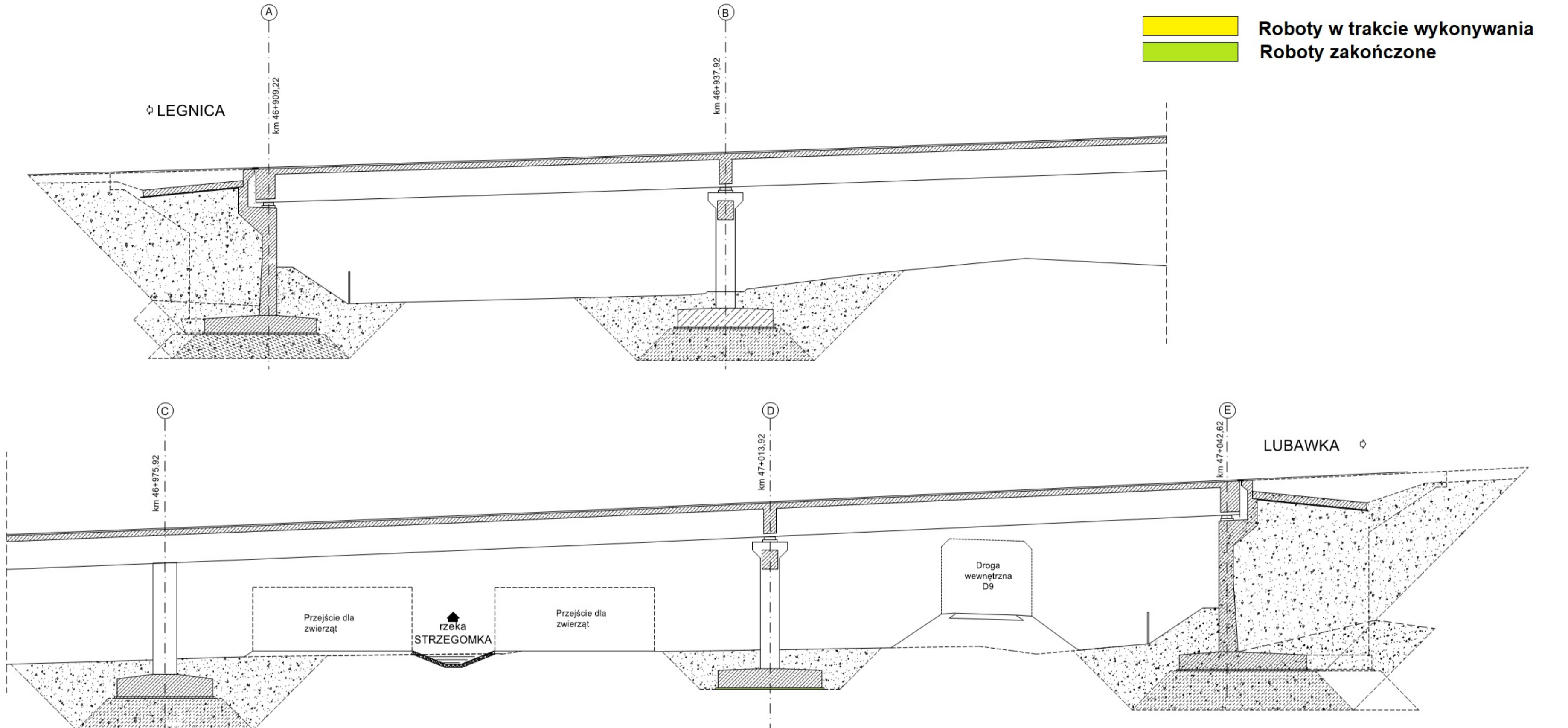

WS-31 km 47+568,12

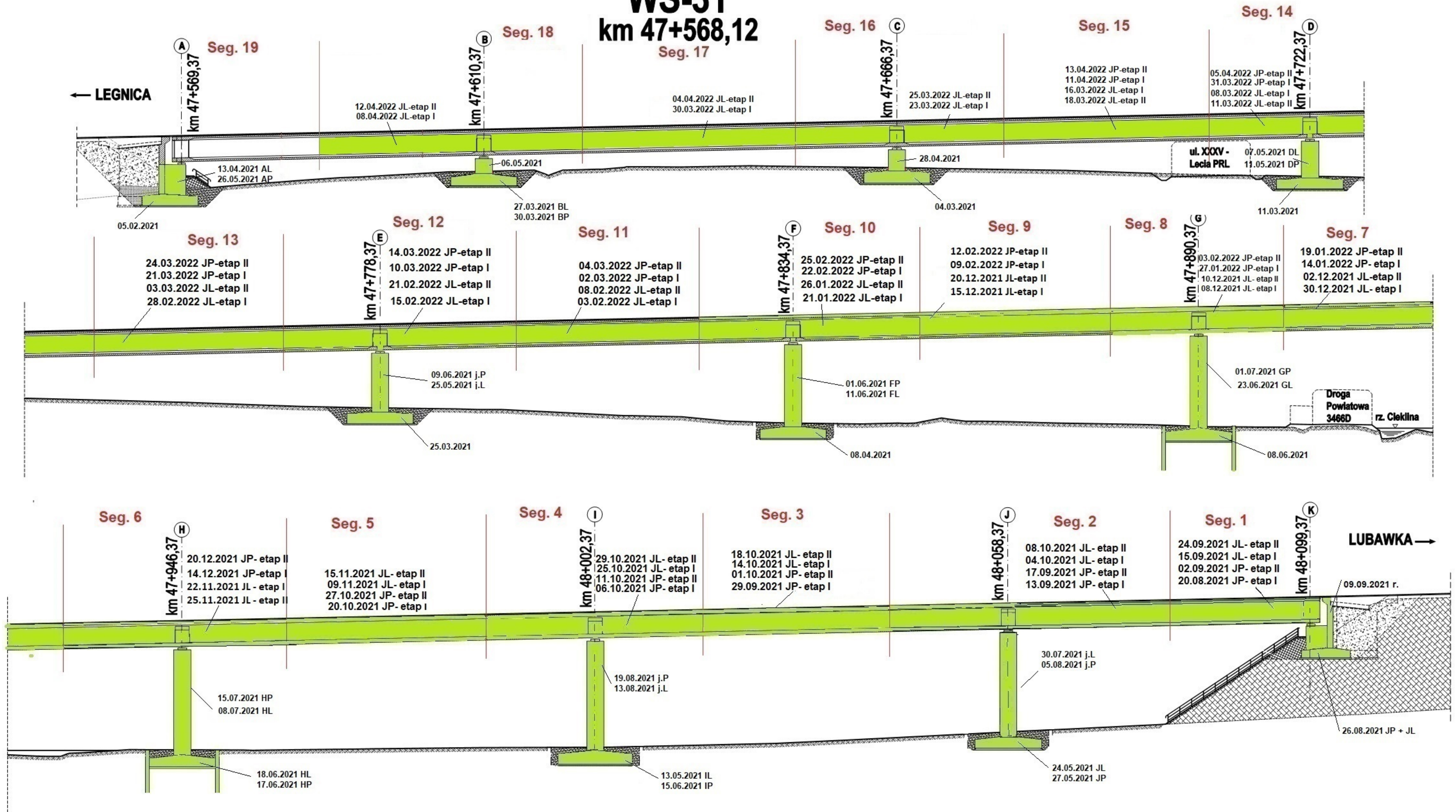

Legenda: Stan na dzień 17.04.2022 r.

- Roboty w trakcie
- Roboty zakończone

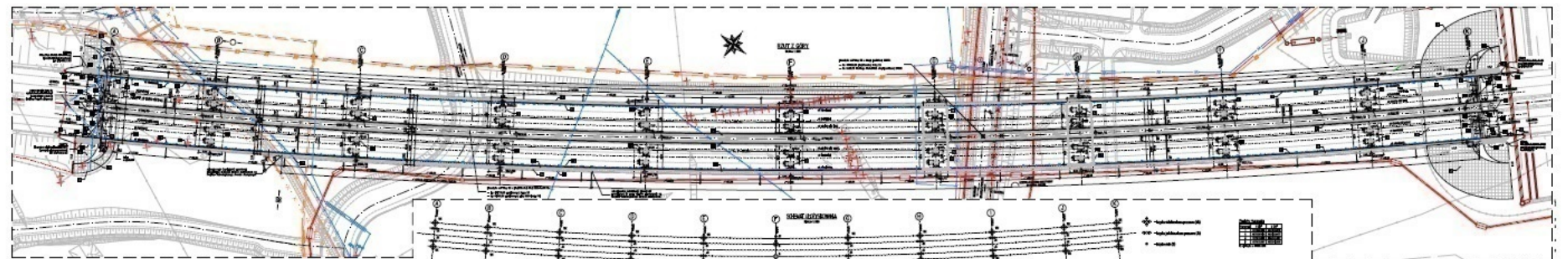
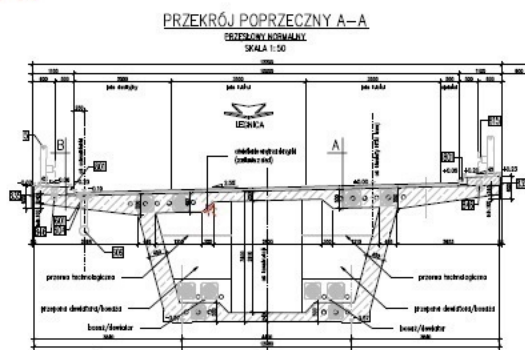

TUNEL TS-32

km 48+680,00 - 49+000,00

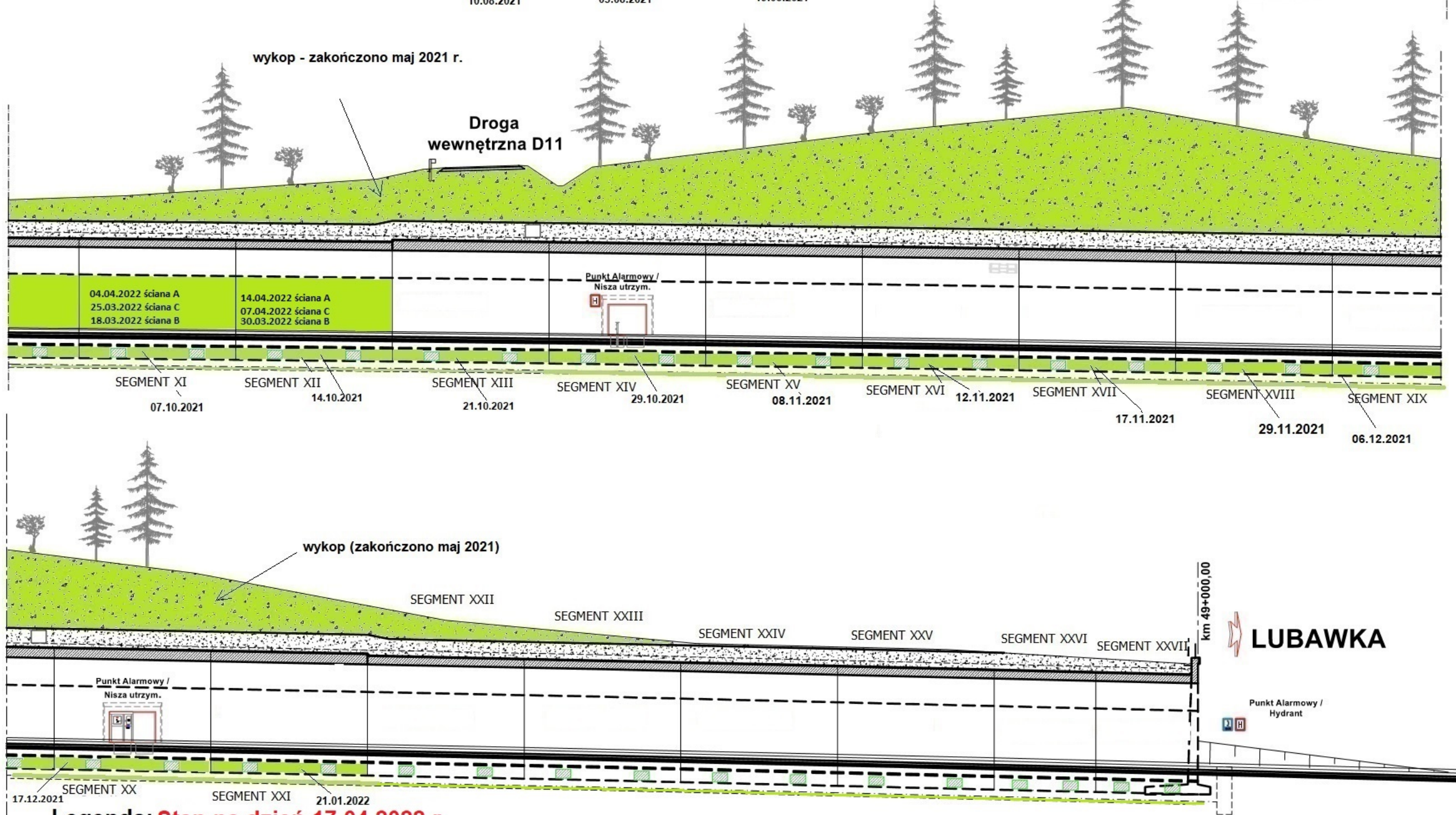
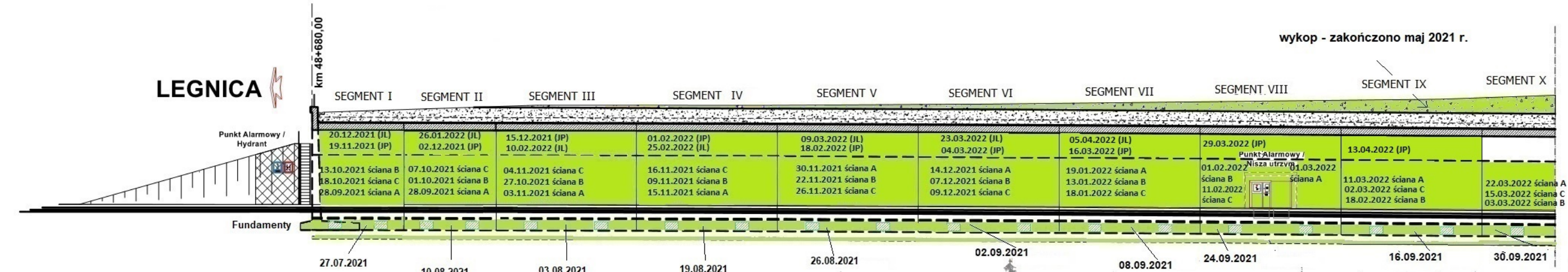

Legenda: Stan na dzień 17.04.2022 r.

- Roboty w trakcie wykonywania
- Roboty zakończone

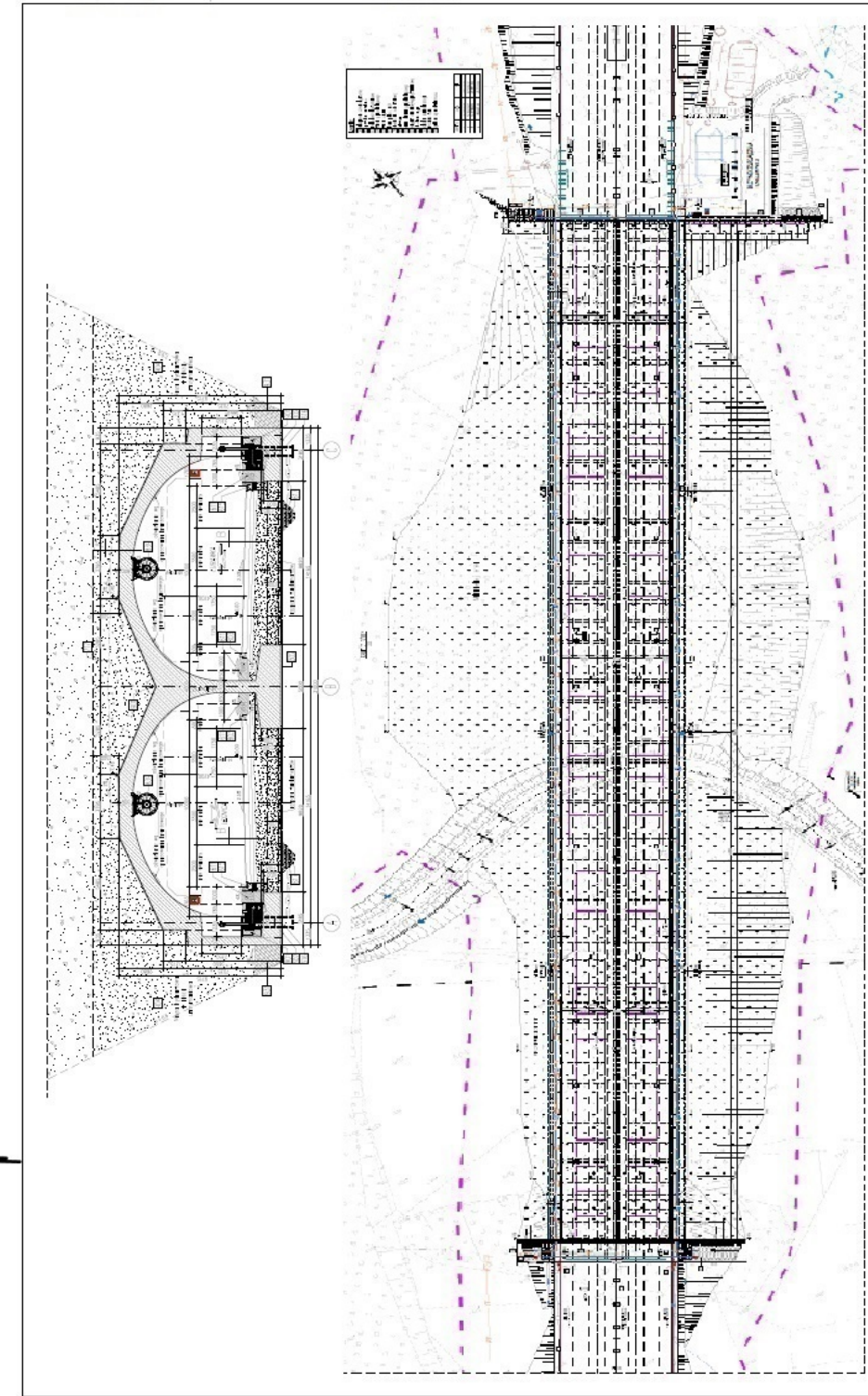

PG 10.1

km 50+097,00

← LEGNICA

LUBAWKA →

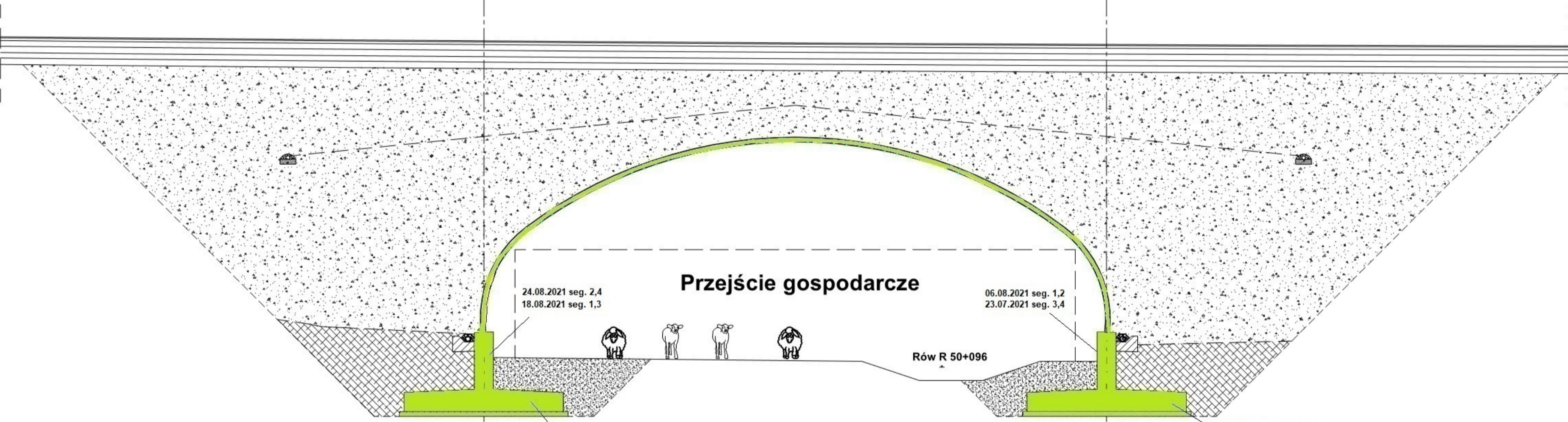

Legenda: Stan na dzień 17.04.2022 r.

- Roboty w trakcie wykonywania
- Roboty zakończone

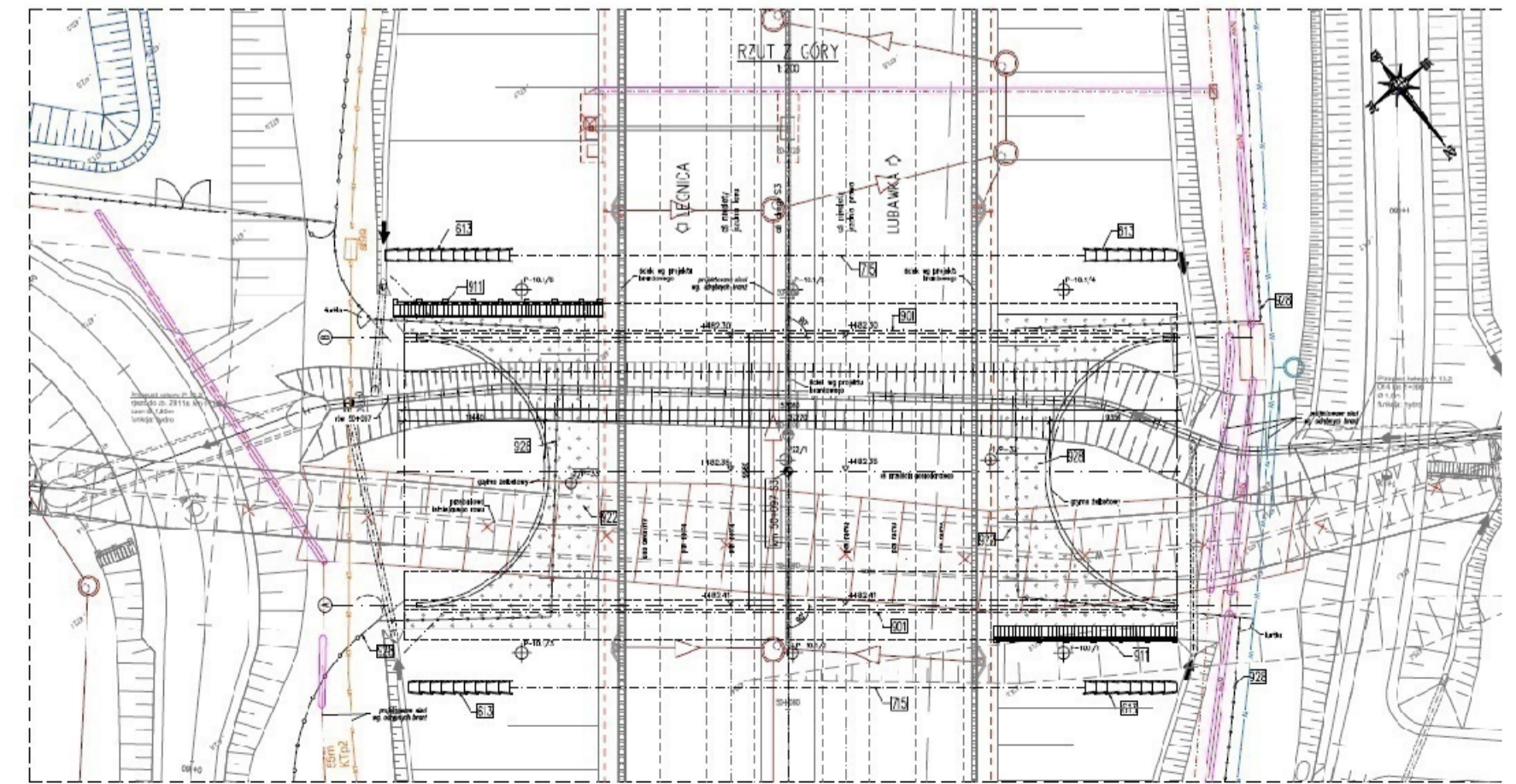
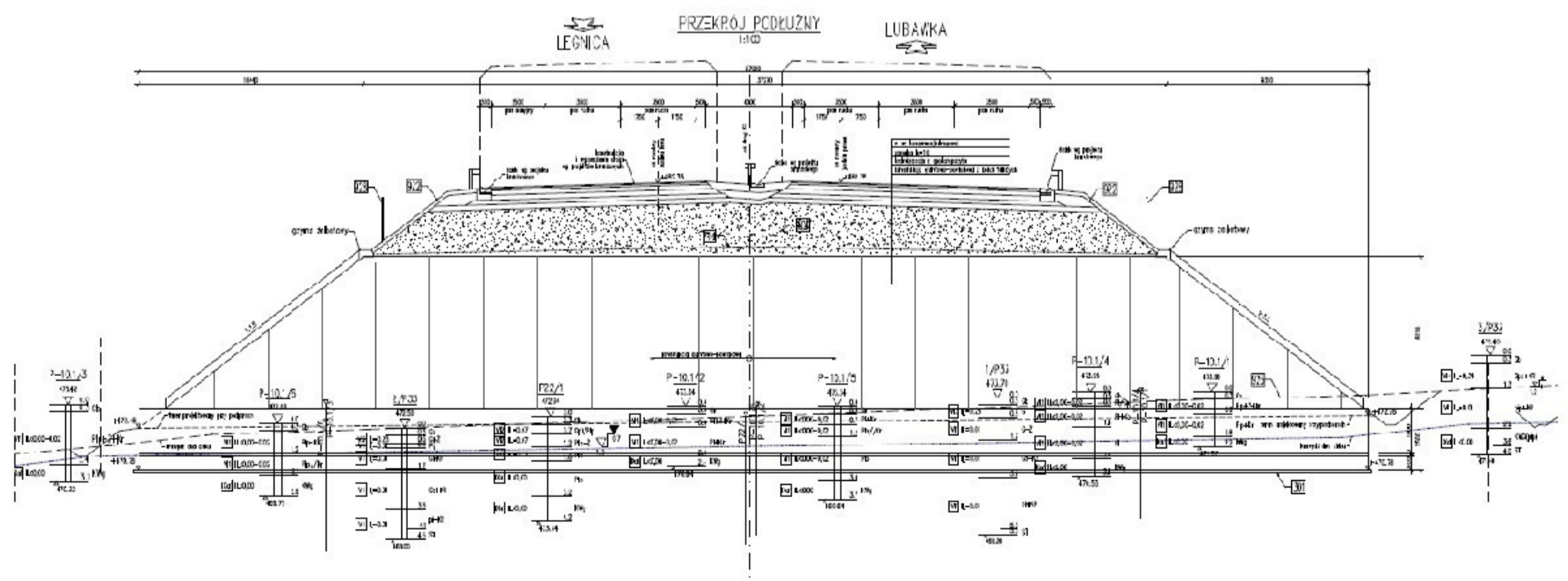

WS-33
km 49+530,70

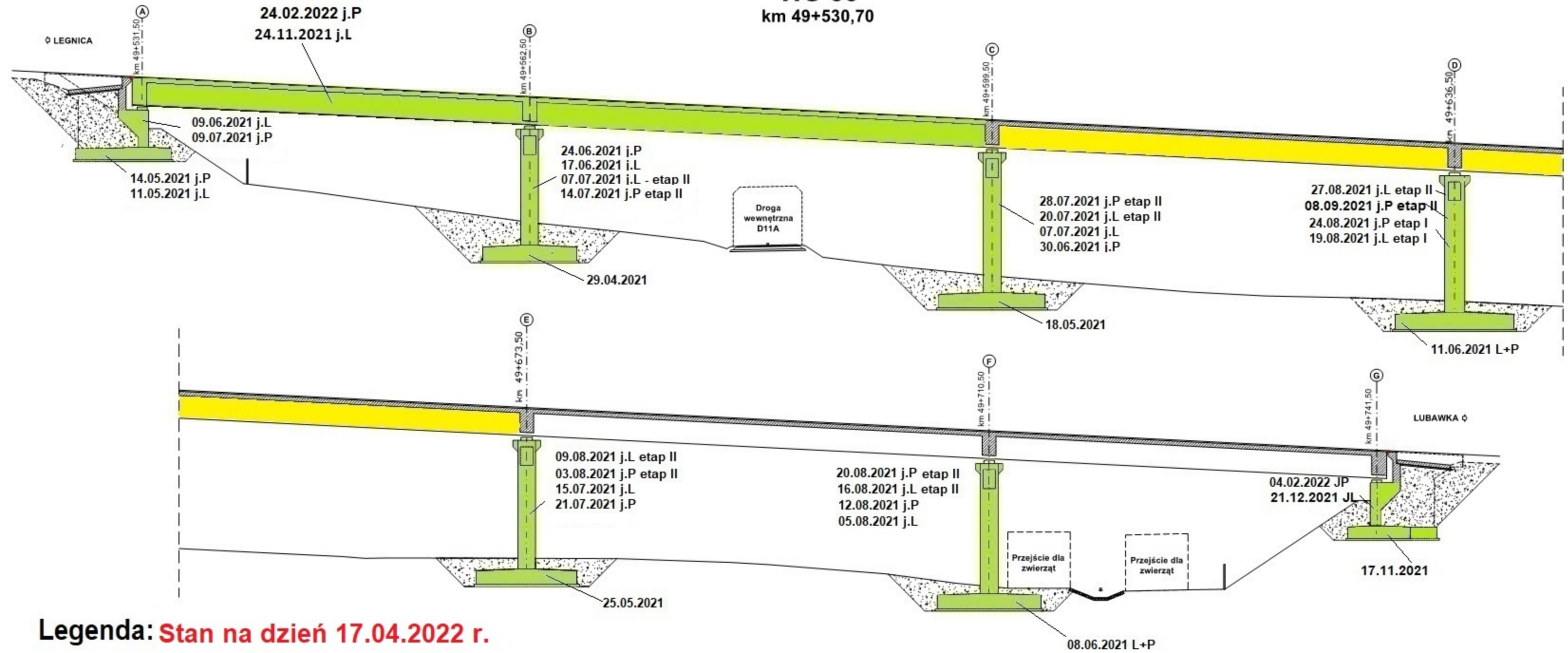

Legenda: Stan na dzień 17.04.2022 r.

- Roboty w trakcie wykonywania
- Roboty zakończone

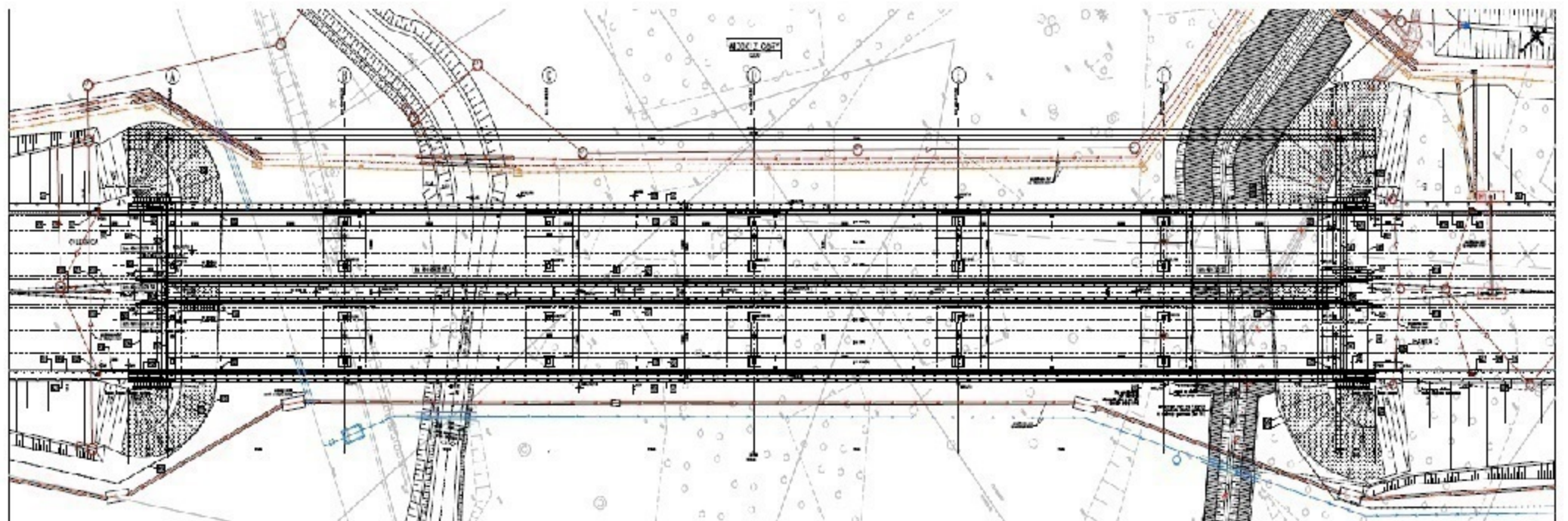
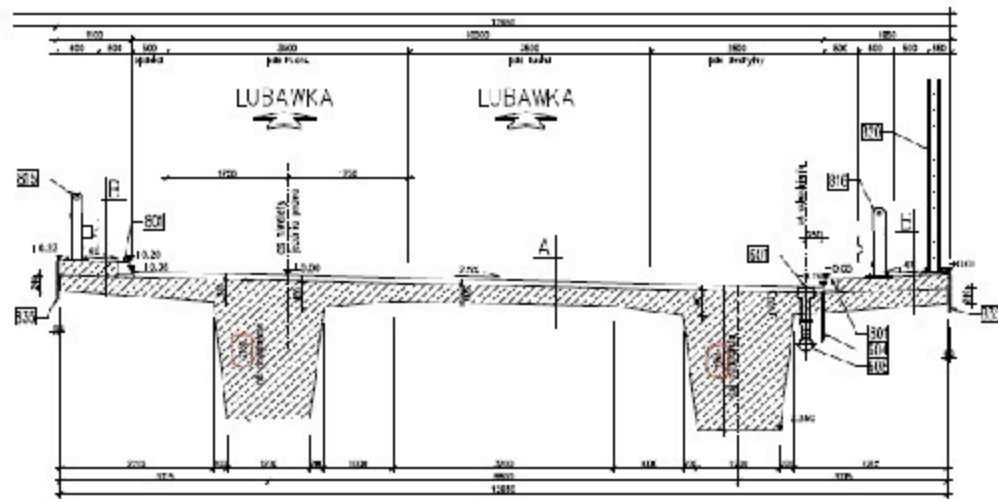

WD-34

km 50+661,15

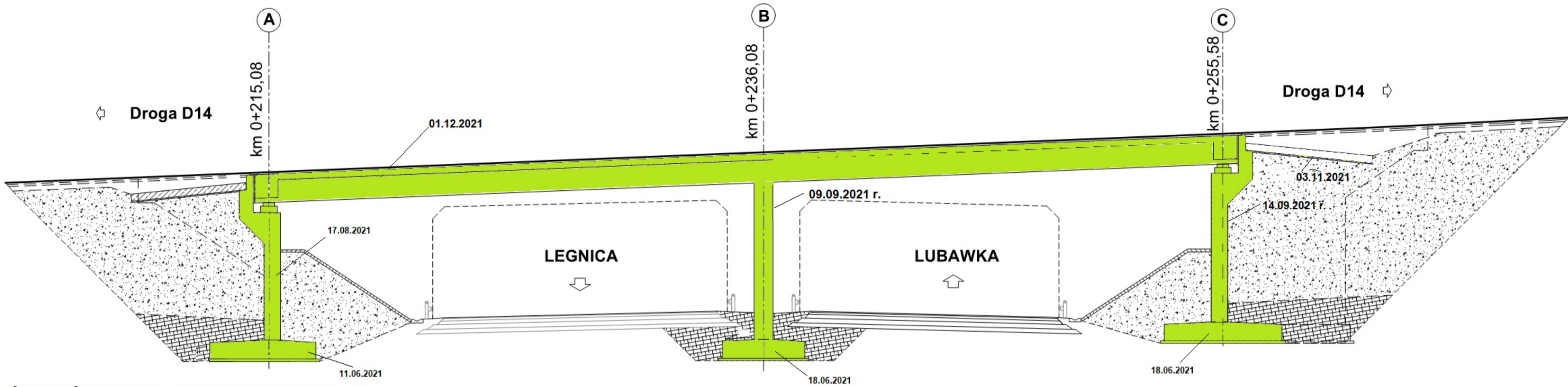

Legenda: Stan na dzień 17.04.2022 r.

- Roboty w trakcie wykonywania
- Roboty zakończone

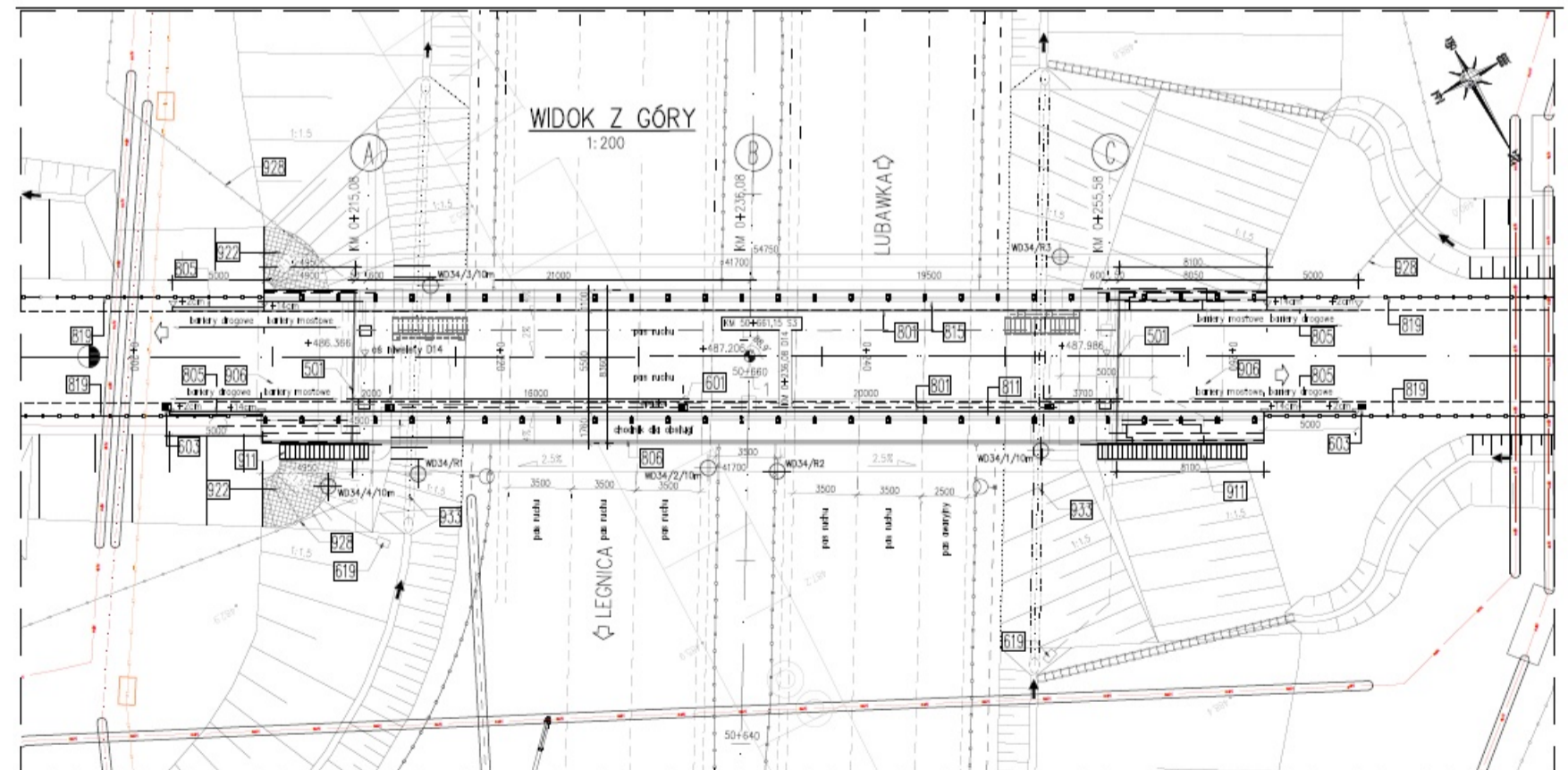

PG 11.1

km 51+249,00

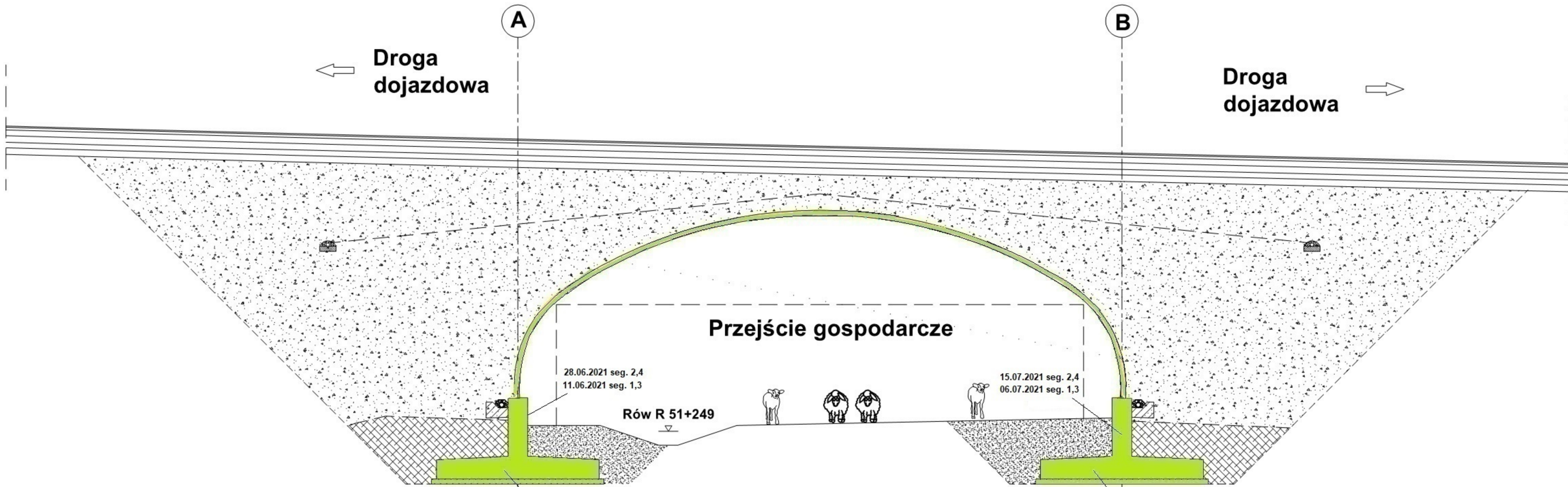

Legenda: Stan na dzień 17.04.2022 r.

- Roboty w trakcie wykonywania
- Roboty zakończone

13.05.2021 seg. 2,4
05.05.2021 seg. 1,3

31.05.2021 seg. 2,4
21.05.2021 seg. 1,3

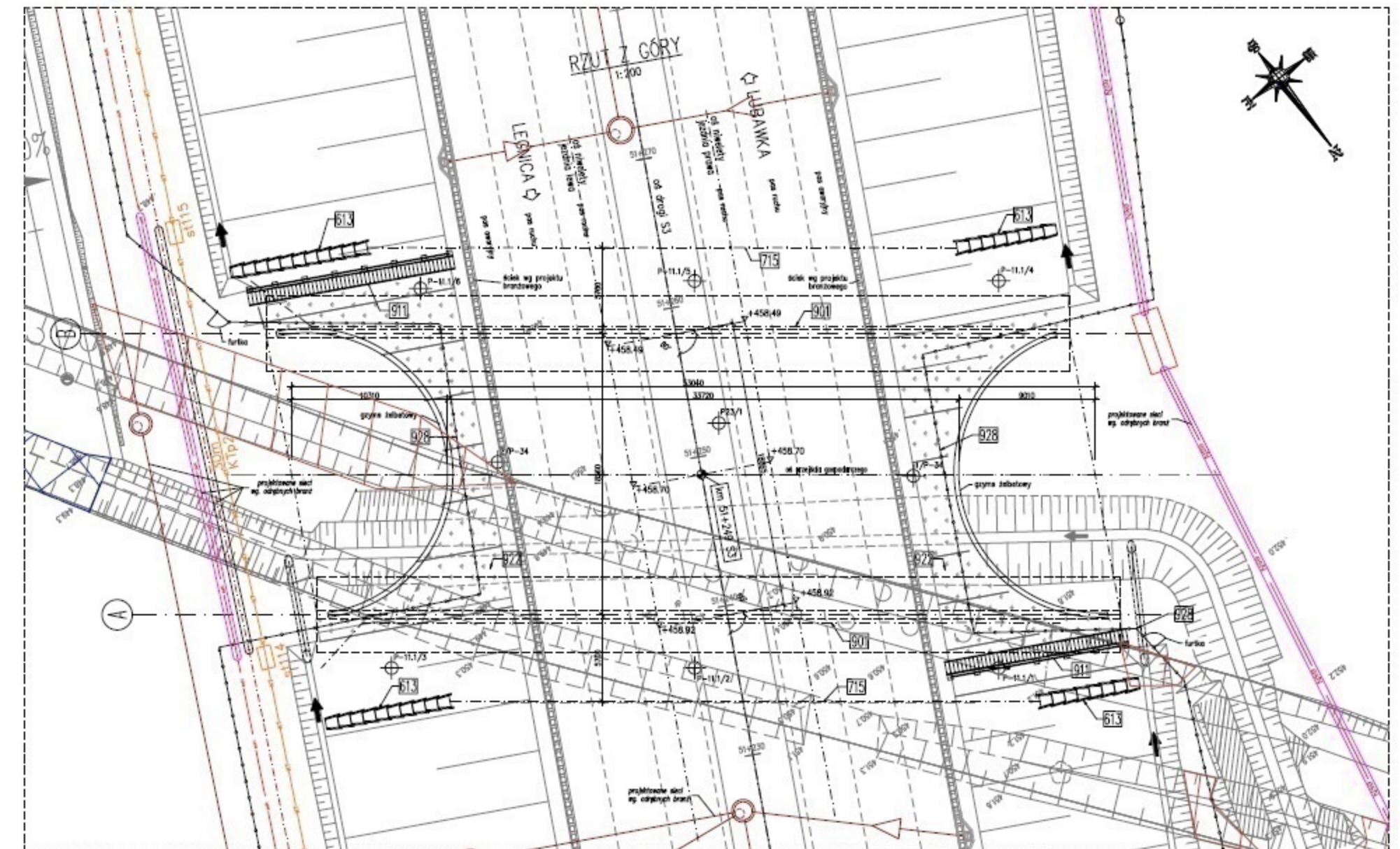
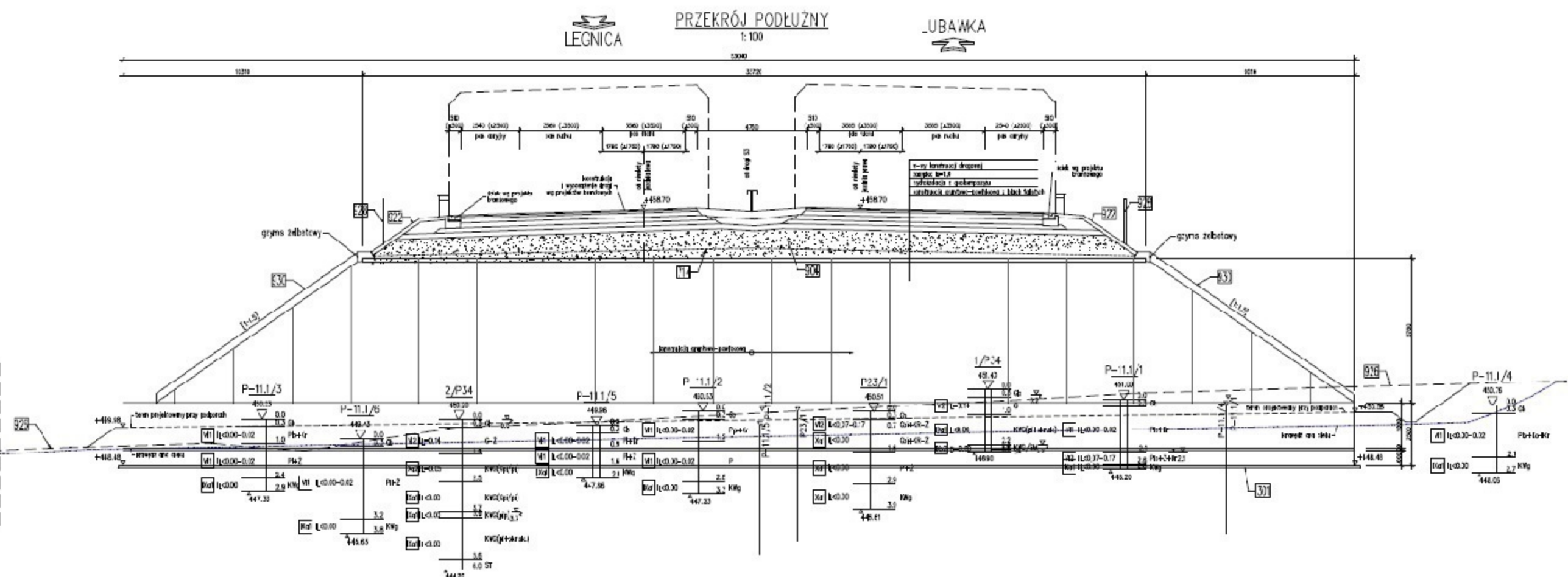

WS-35 km 51+508,81

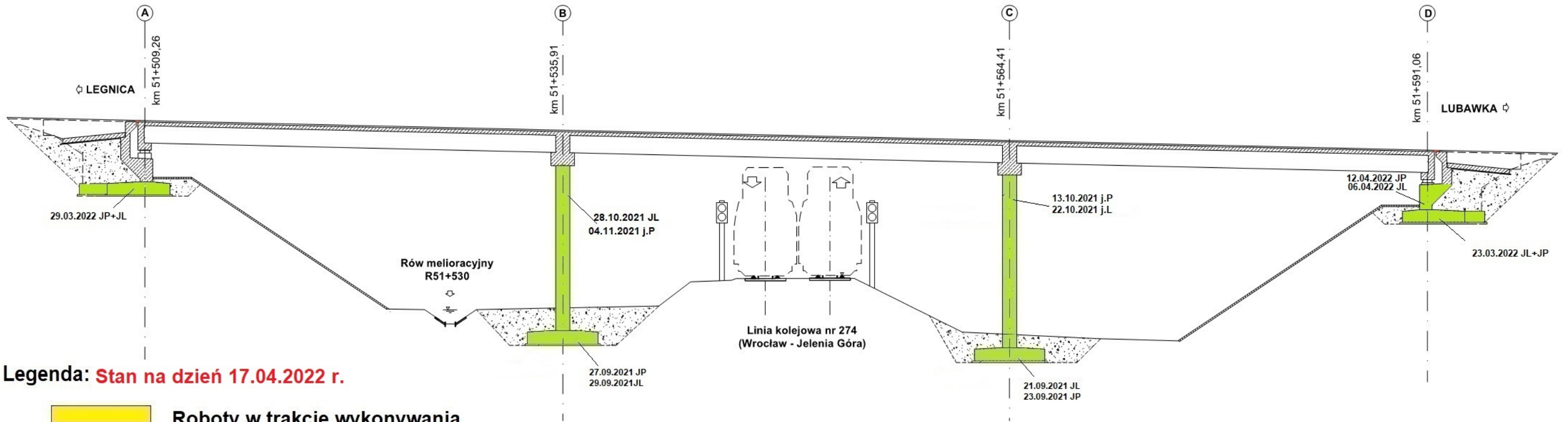

Legenda: Stan na dzień 17.04.2022 r.

- Roboty w trakcie wykonywania
- Roboty zakończone

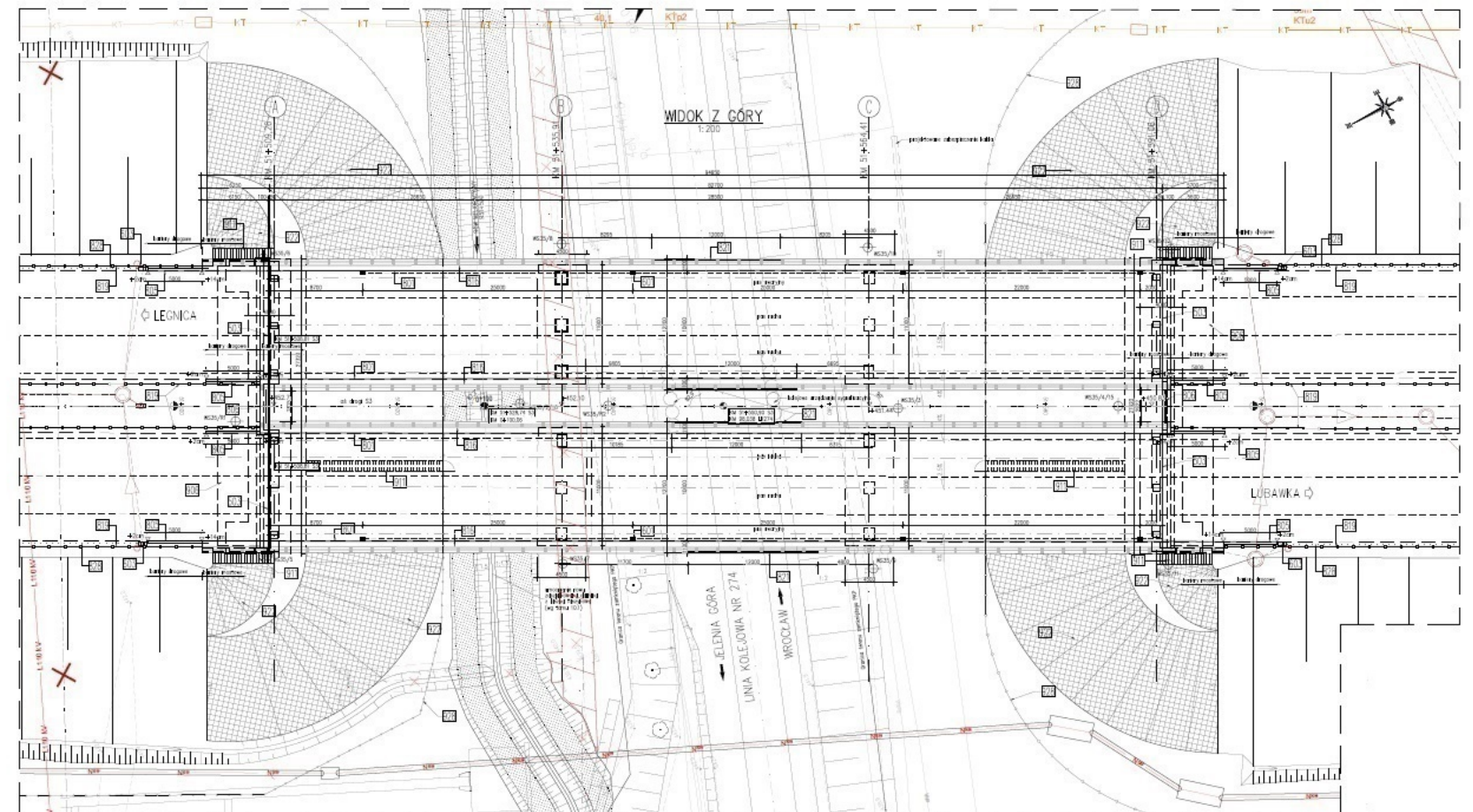
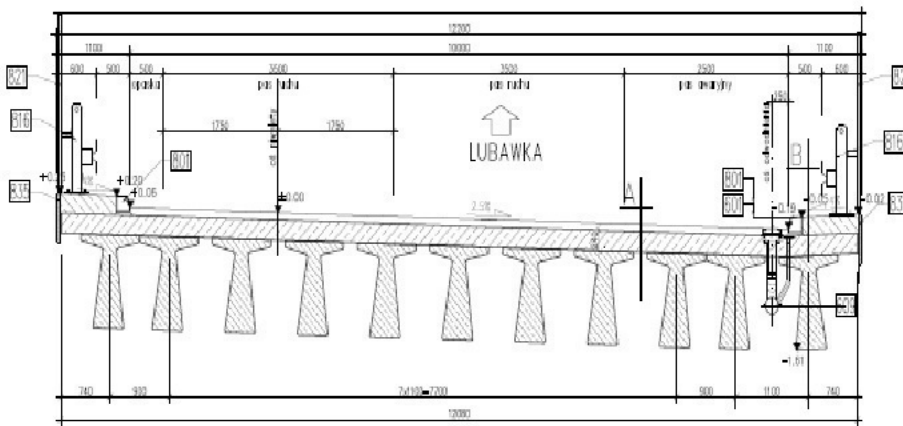

WS-36

km 51+780,95

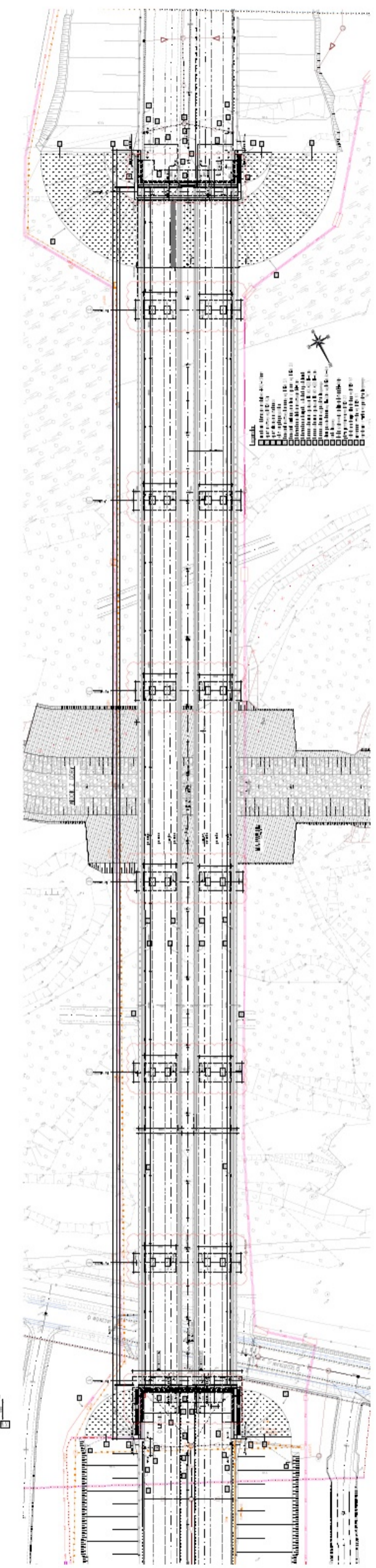
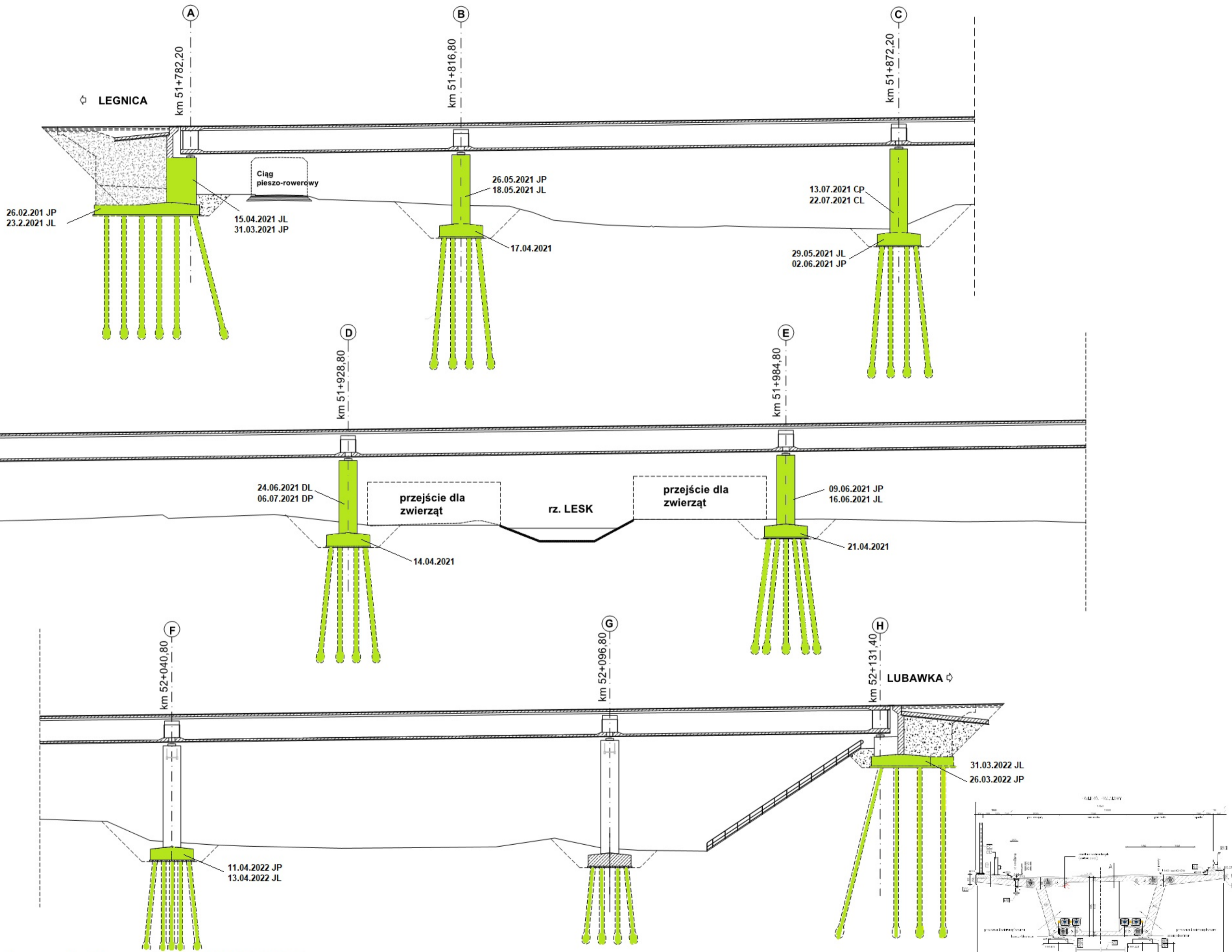

Legenda: Stan na dzień 17.04.2022 r.

- Roboty w trakcie wykonywania
- Roboty zakończone

WS-37

km 52+994,25

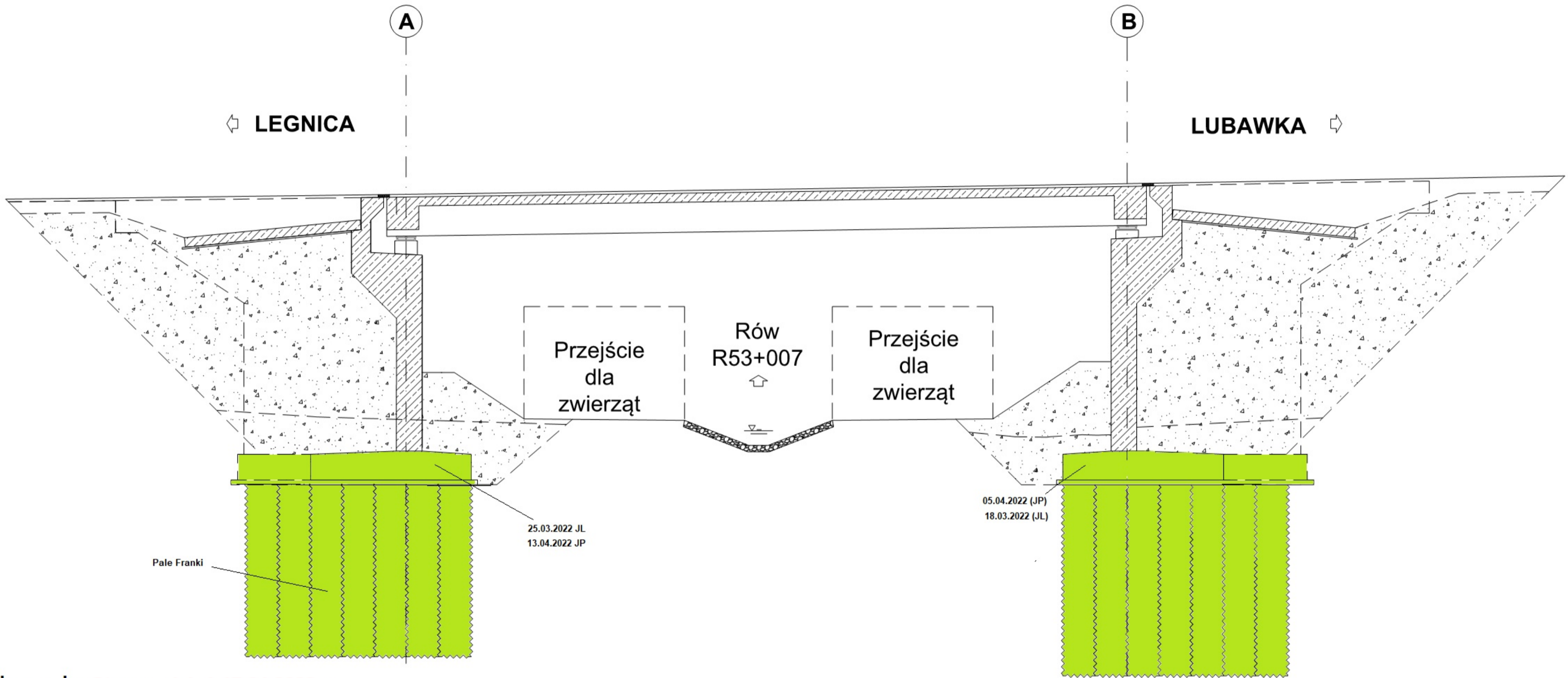

Legenda: Stan na dzień 17.04.2022 r.

- Roboty w trakcie wykonywania
- Roboty zakończone

PRZEKRÓJ POPRZECZNY
PRZESELOWY, NORMALNY
1:50

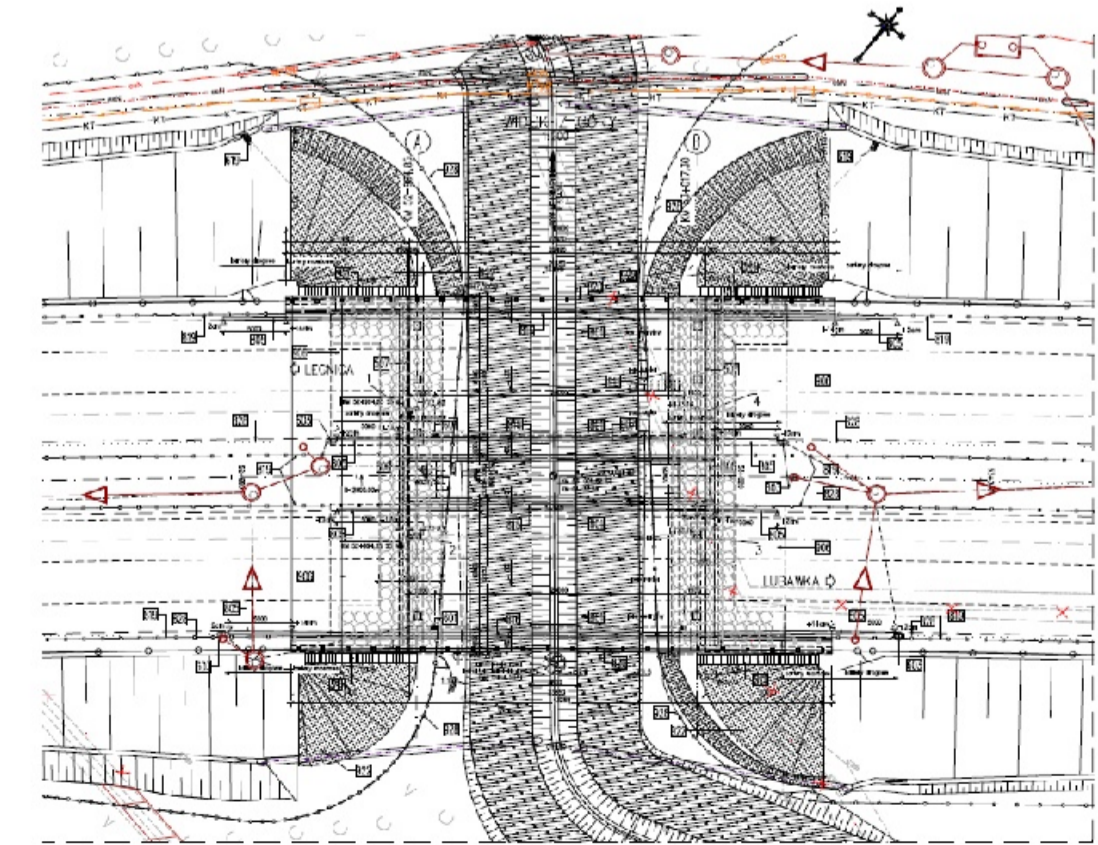
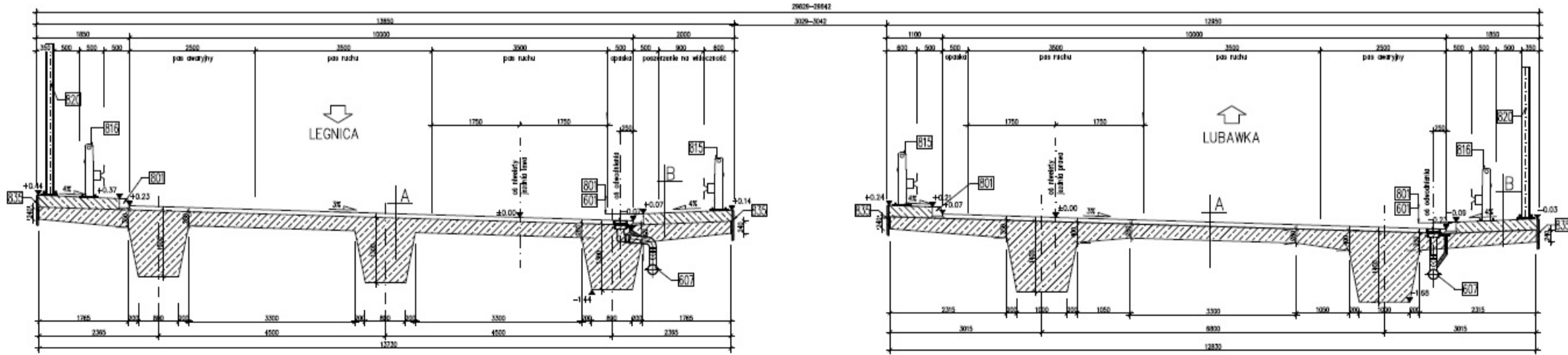

WD-38

km 53+798,79

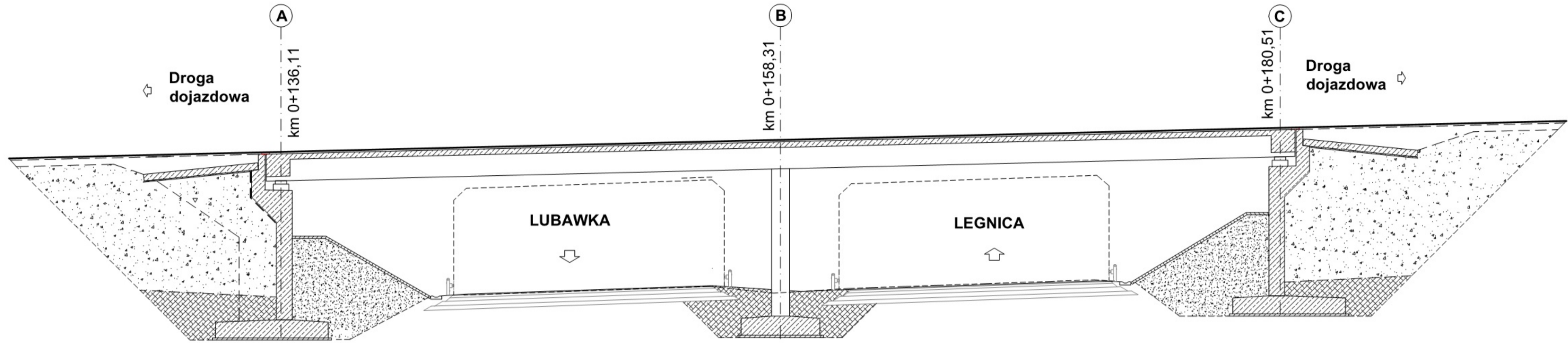

Legenda: Stan na dzień 17.04.2022 r.

- Roboty w trakcie wykonywania
- Roboty zakończone

PRZEKRÓJ POPRZECZNY
PRZESŁOWY, NORMALNY
1:30

