

WD-22

km 38+491,21

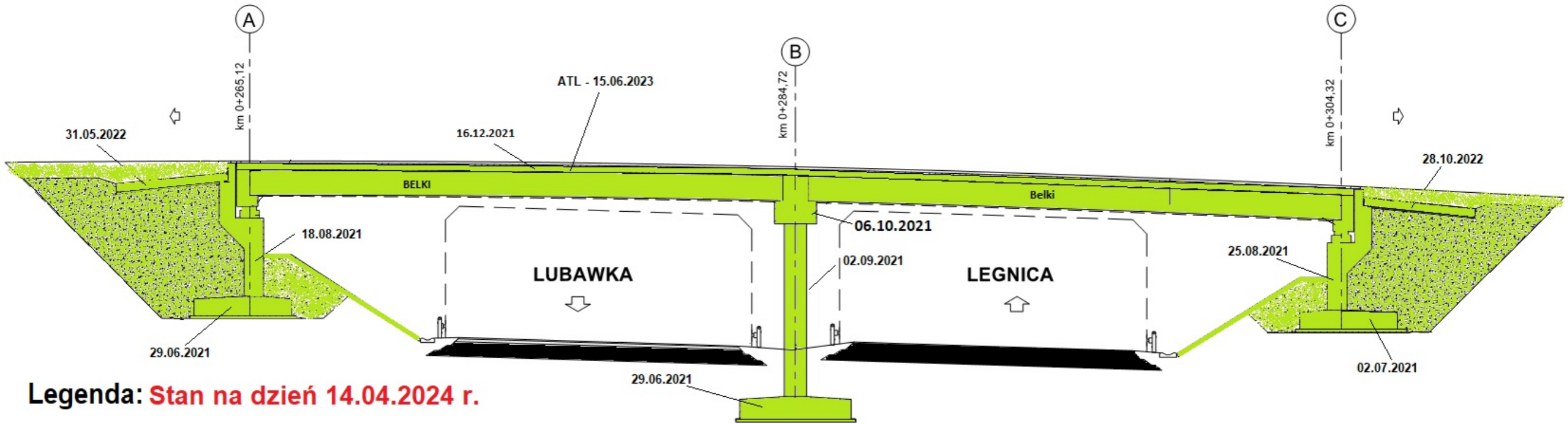

Legenda: **Stan na dzień 14.04.2024 r.**

- Roboty w trakcie wykonywania
- Roboty zakończone

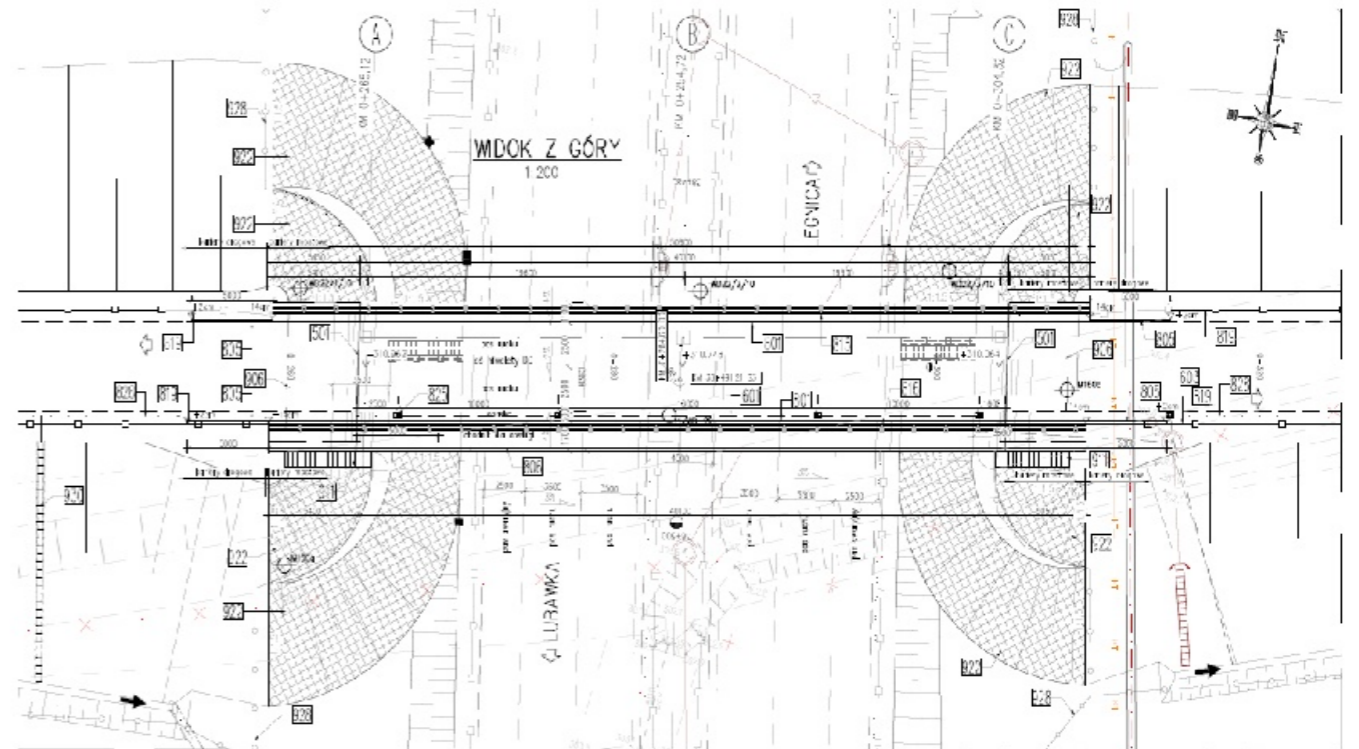
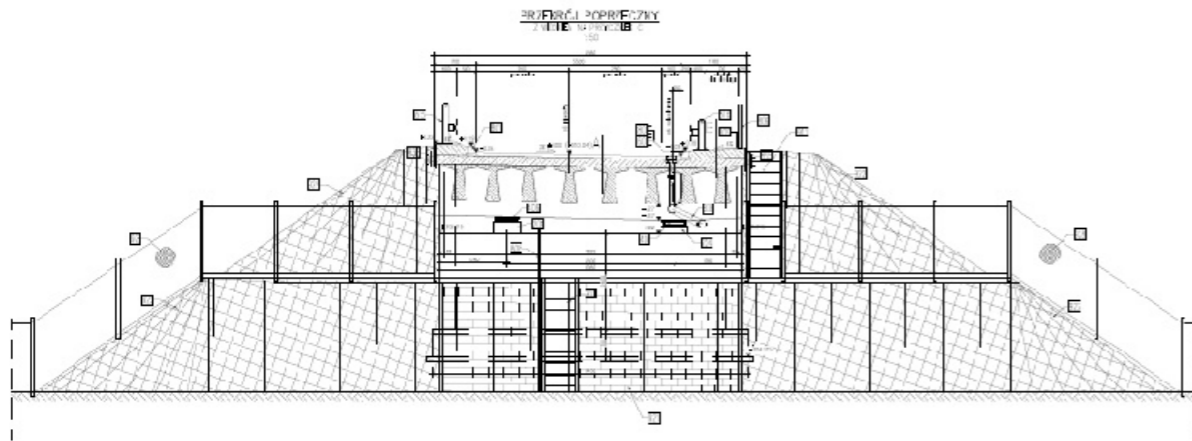

WS-24

km 41+431,41

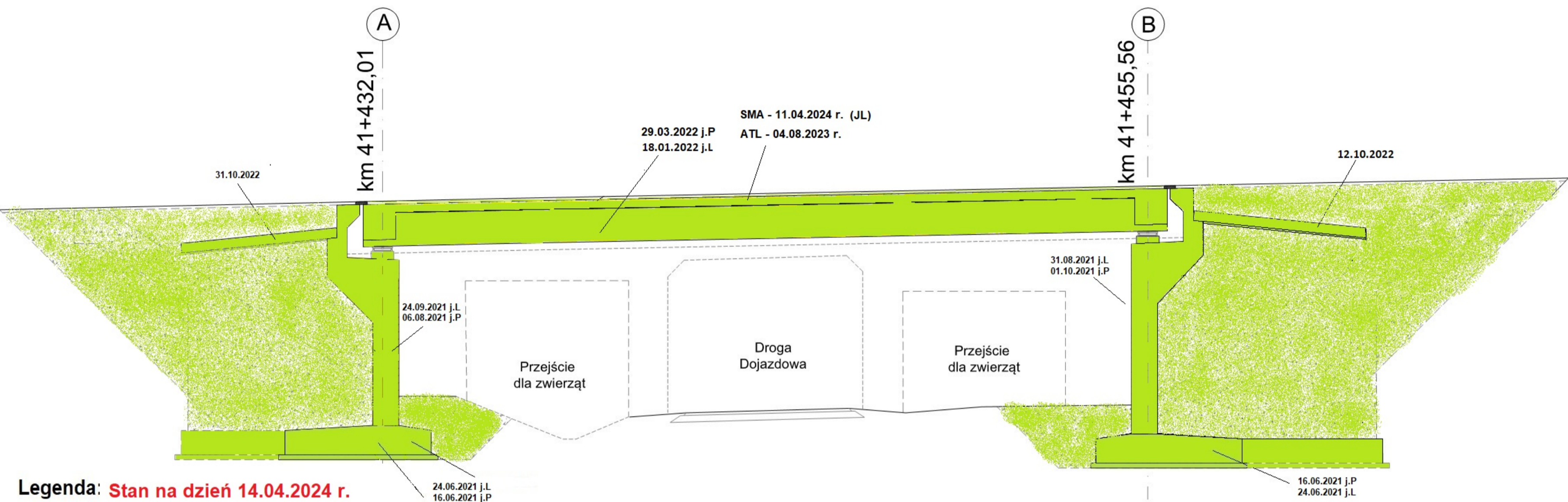

Legenda: Stan na dzień 14.04.2024 r.

- Roboty w trakcie wykonywania
- Roboty zakończone



MS-25

km 41+996,65

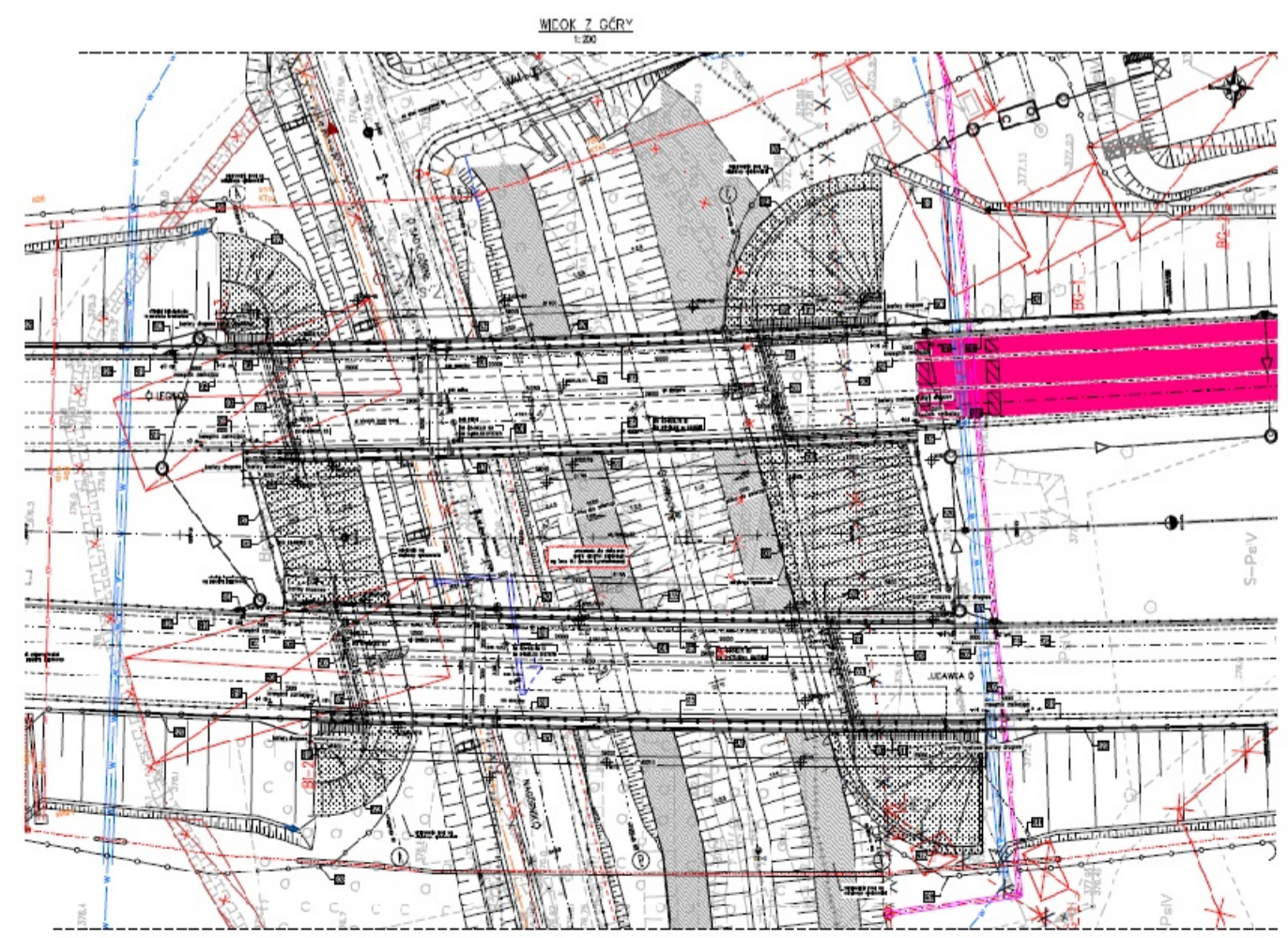
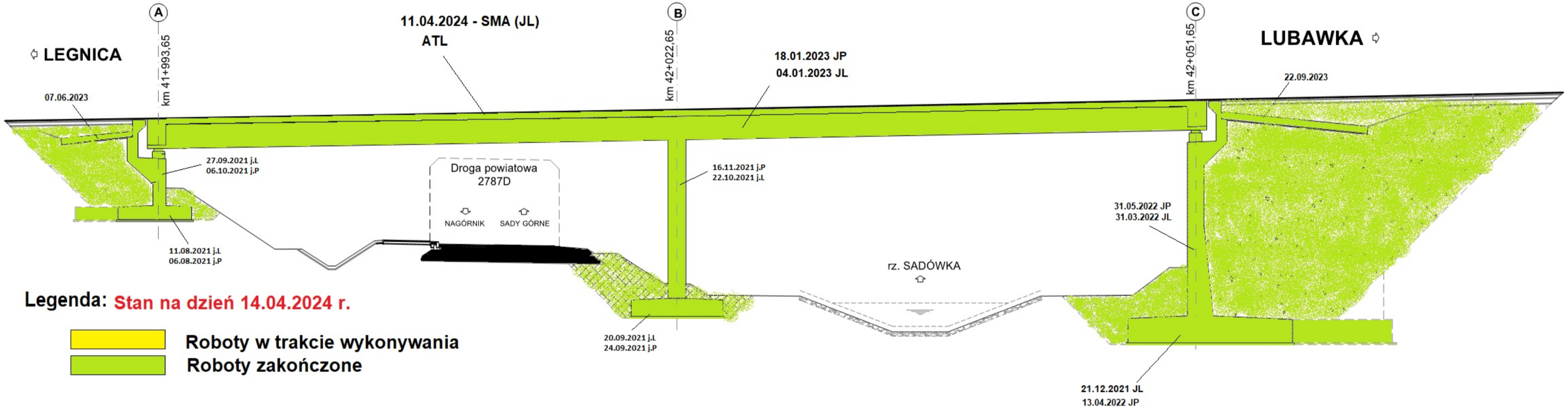

WD-27

km 44+702,77

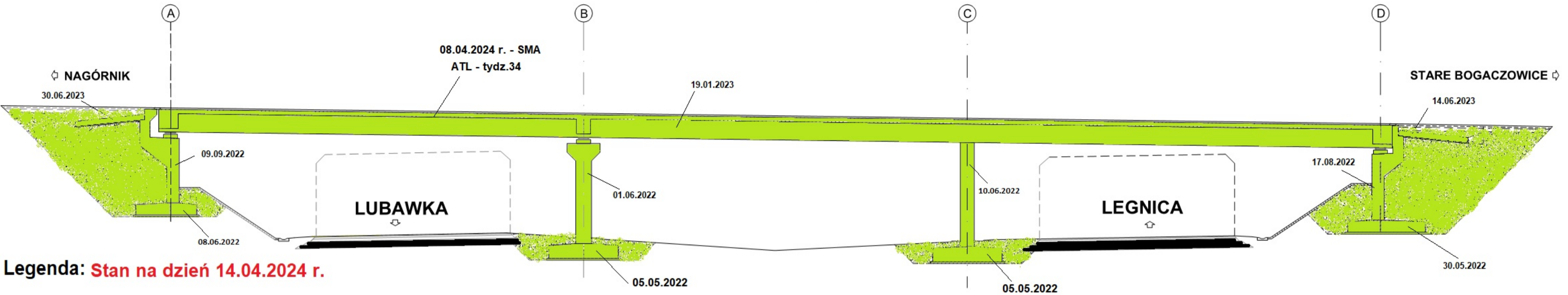

Legenda: Stan na dzień 14.04.2024 r.

- Roboty w trakcie wykonywania
- Roboty zakończone

PRZEKRÓJ POPRZECZNY
Z WIDOKIEM NA FILAR
1:50

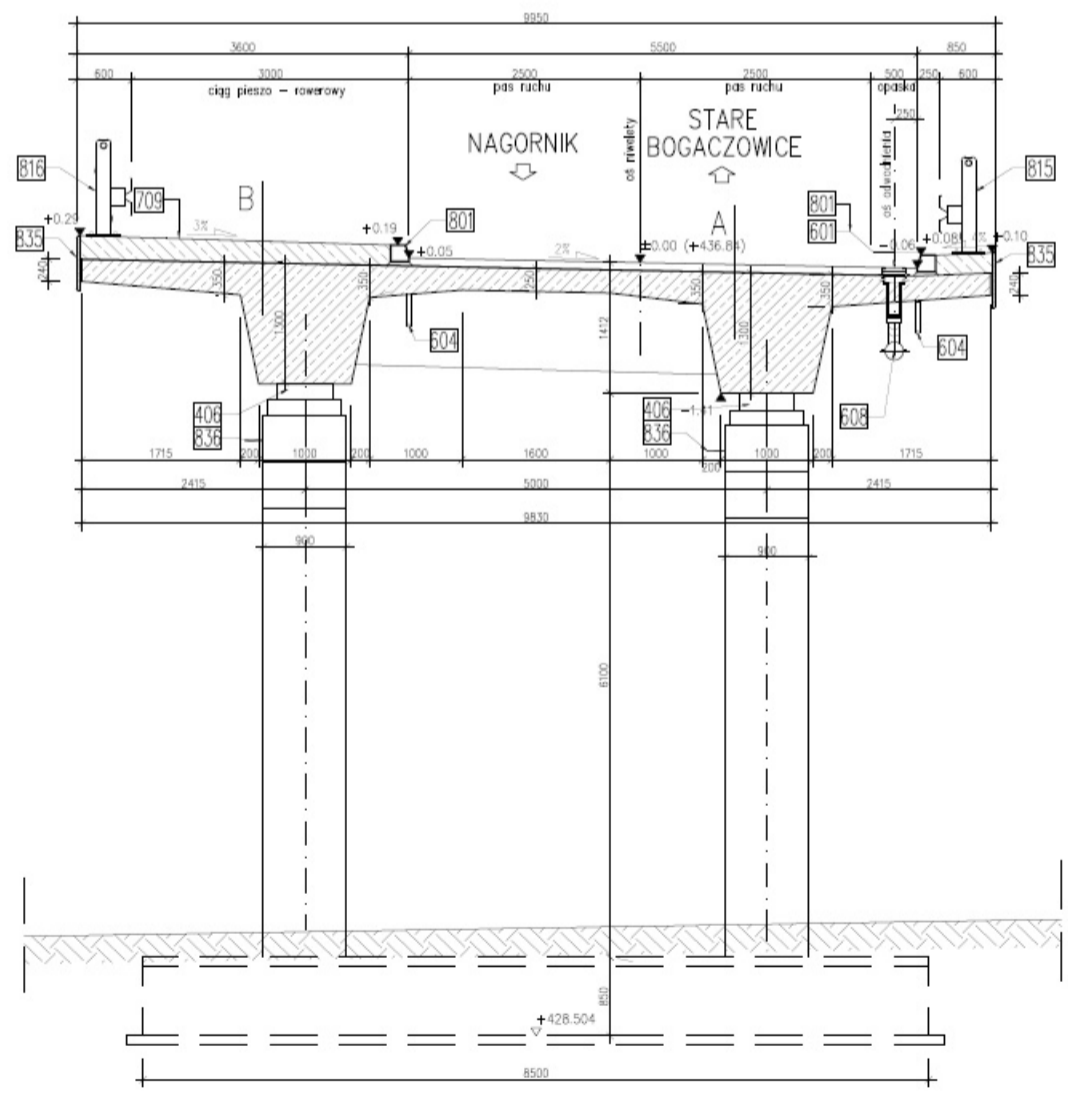

WIDOK Z GÓRY
1:200

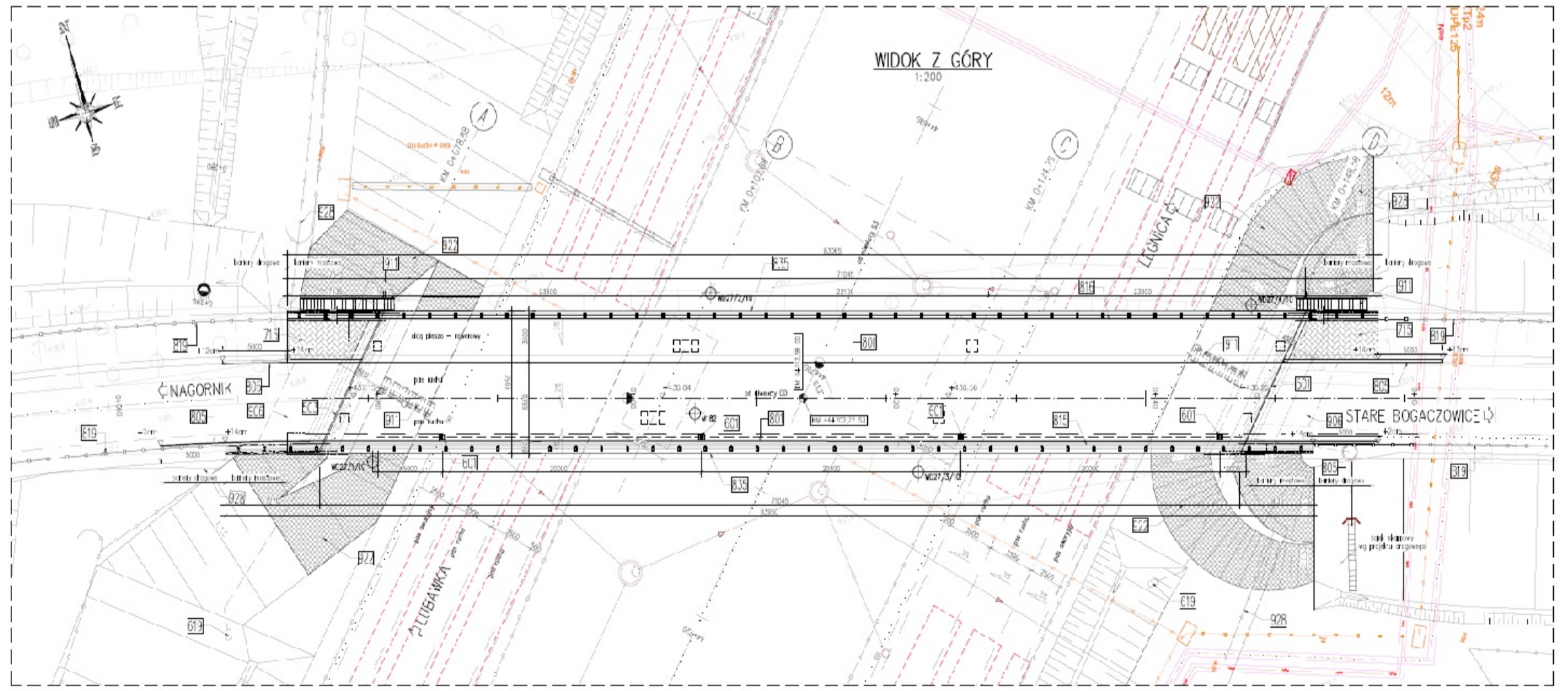

PG-29

km 46+743,46

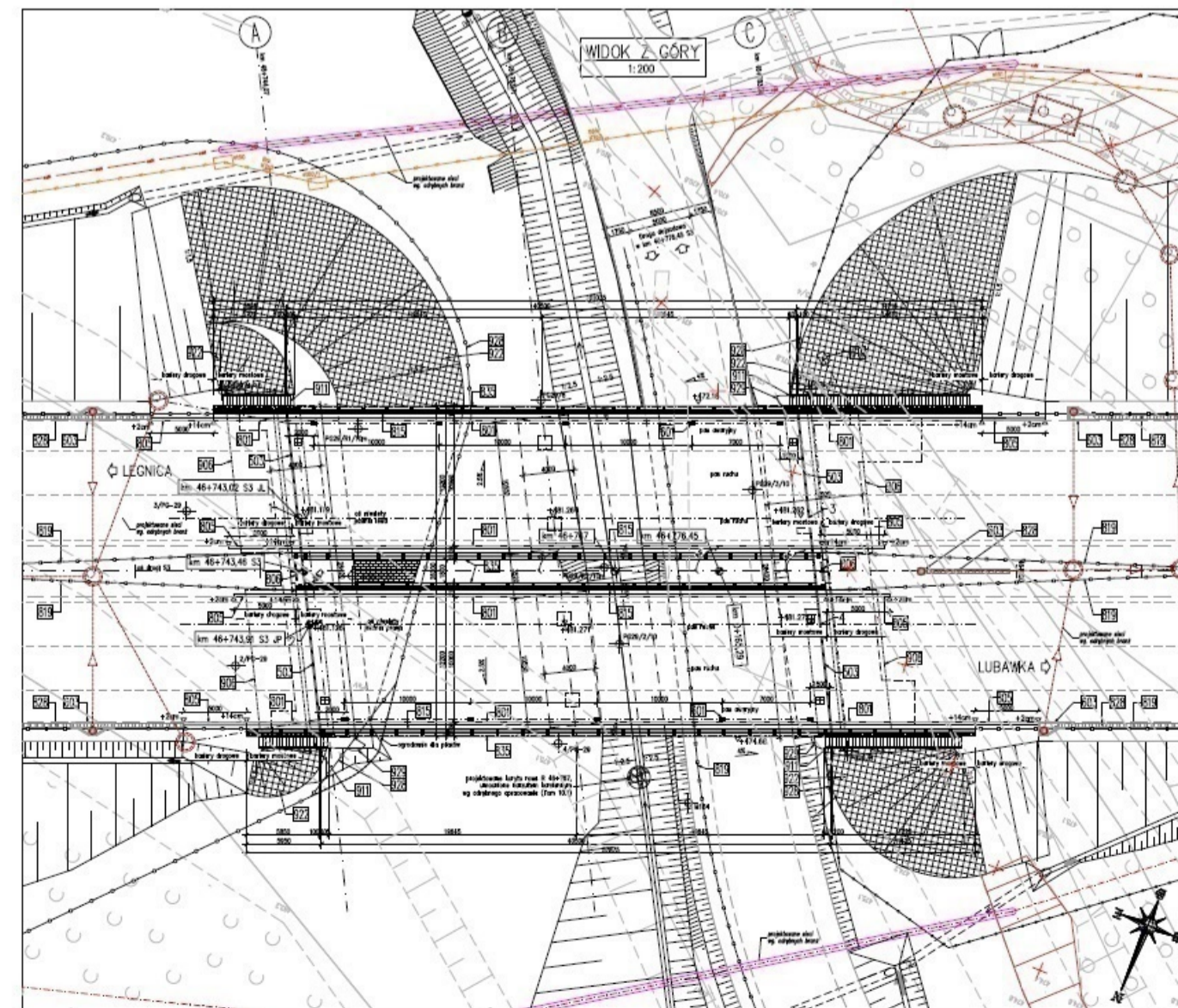
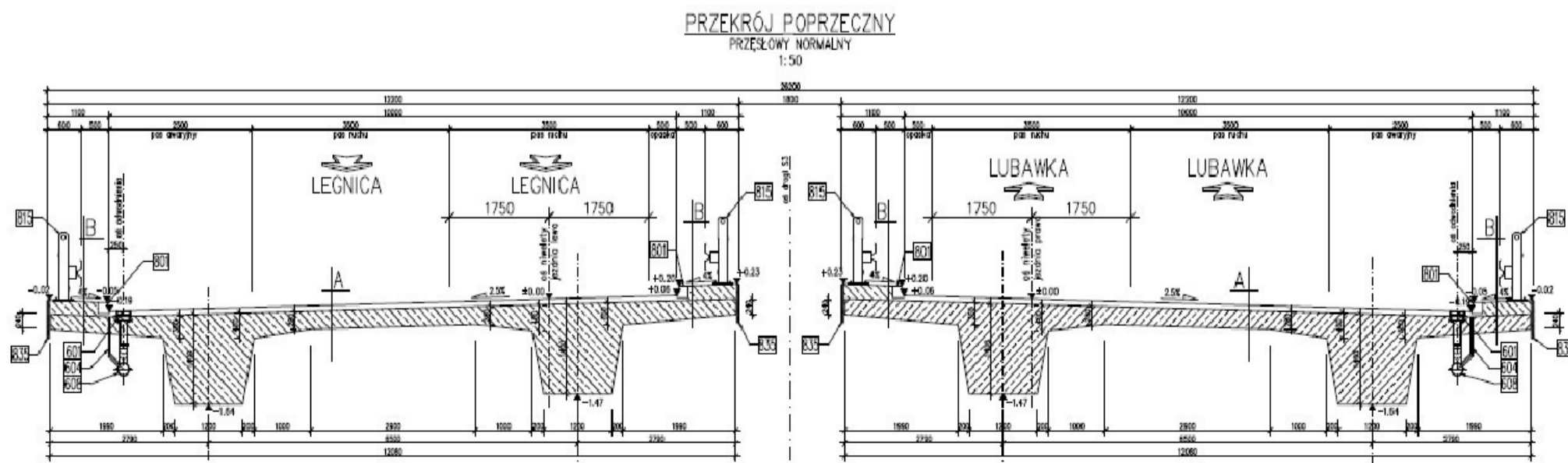
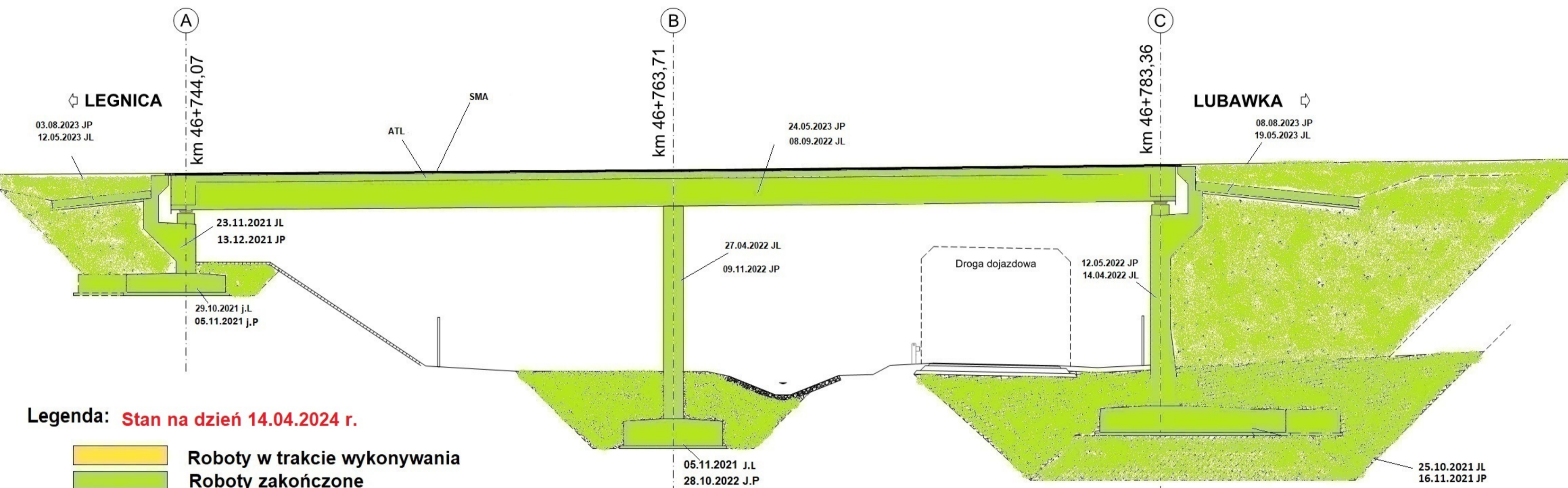

WS-30

km 46+908.42

Legenda Stan na dzień 14.04.2024 r.

- Roboty w trakcie wykonywania
- Roboty zakończone

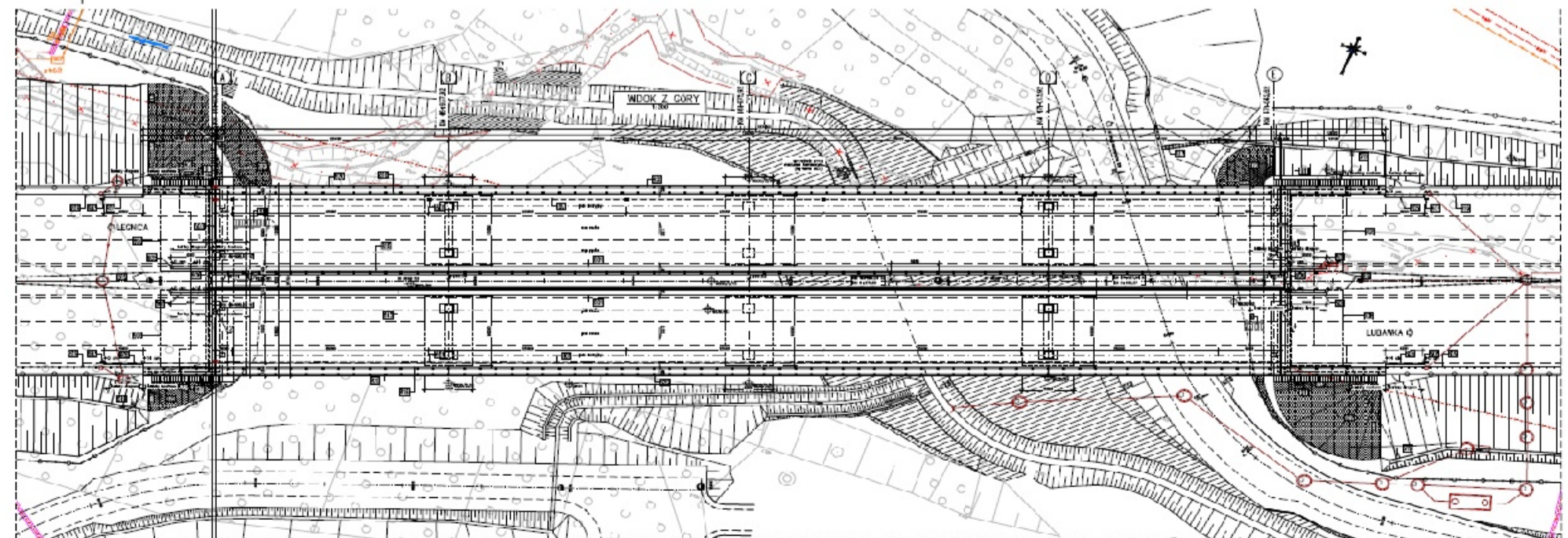
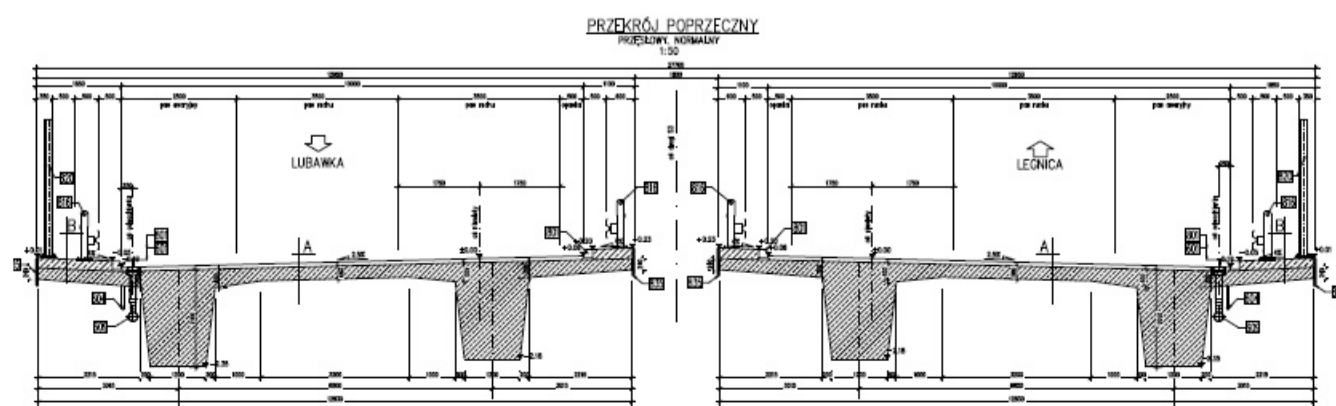
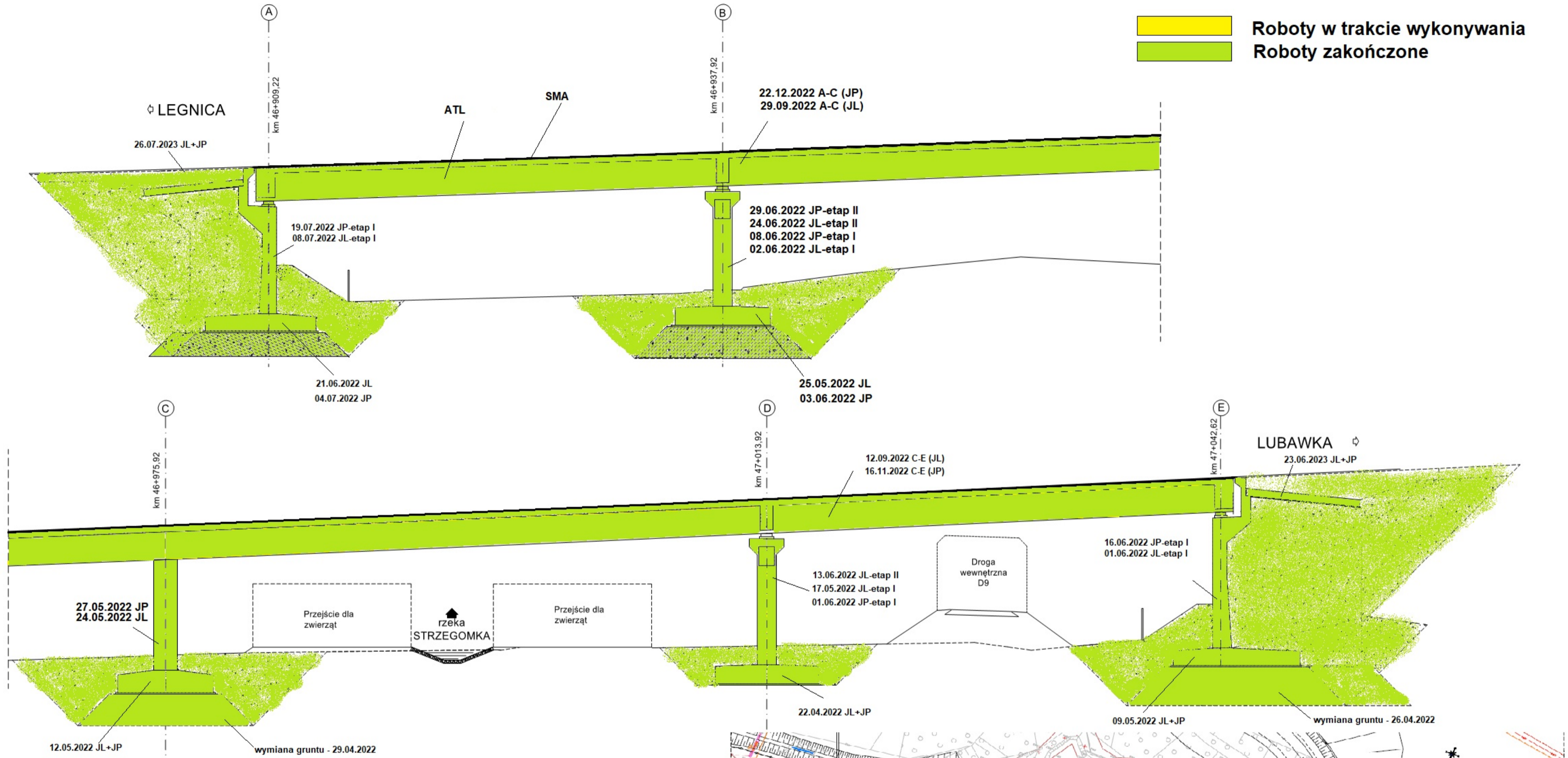

WS-31 km 47+568,12

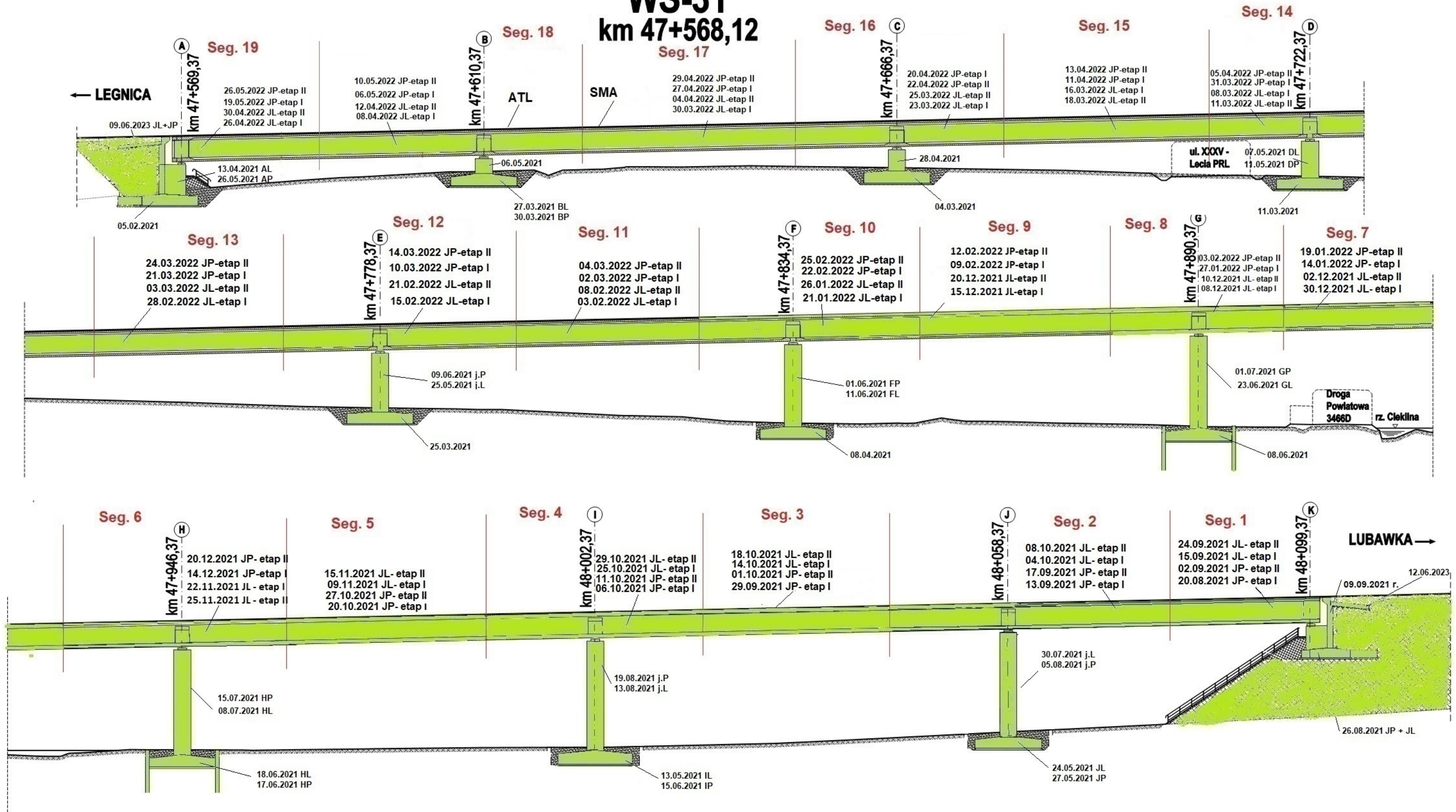

Legenda: Stan na dzień 14.04.2024 r.

- Roboty w trakcie
- Roboty zakończone

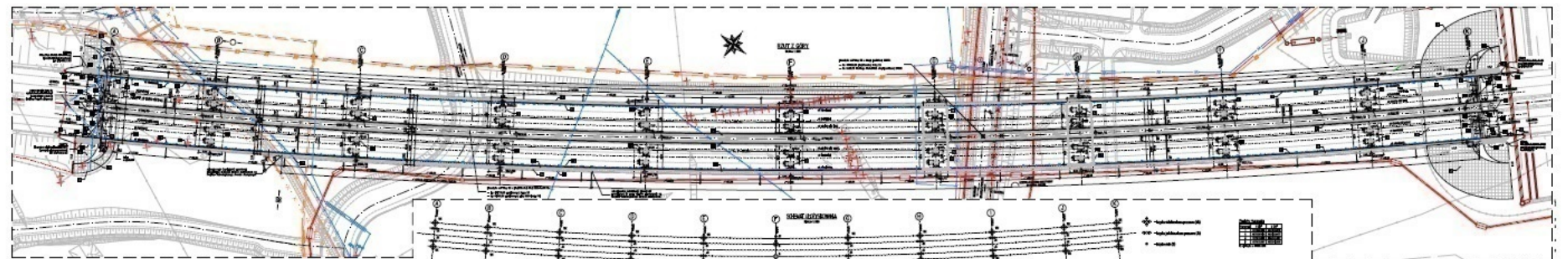
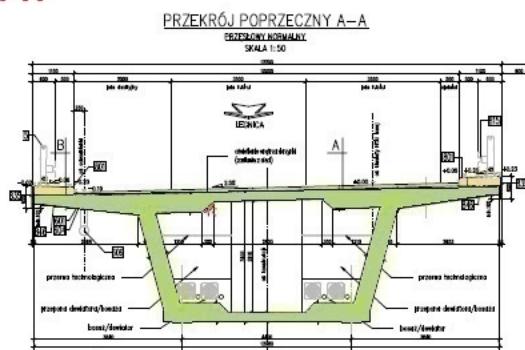

TUNEL TS-32

km 48+680,00 - 49+000,00

wykop - zakończono maj 2021 r.

LEGNICA

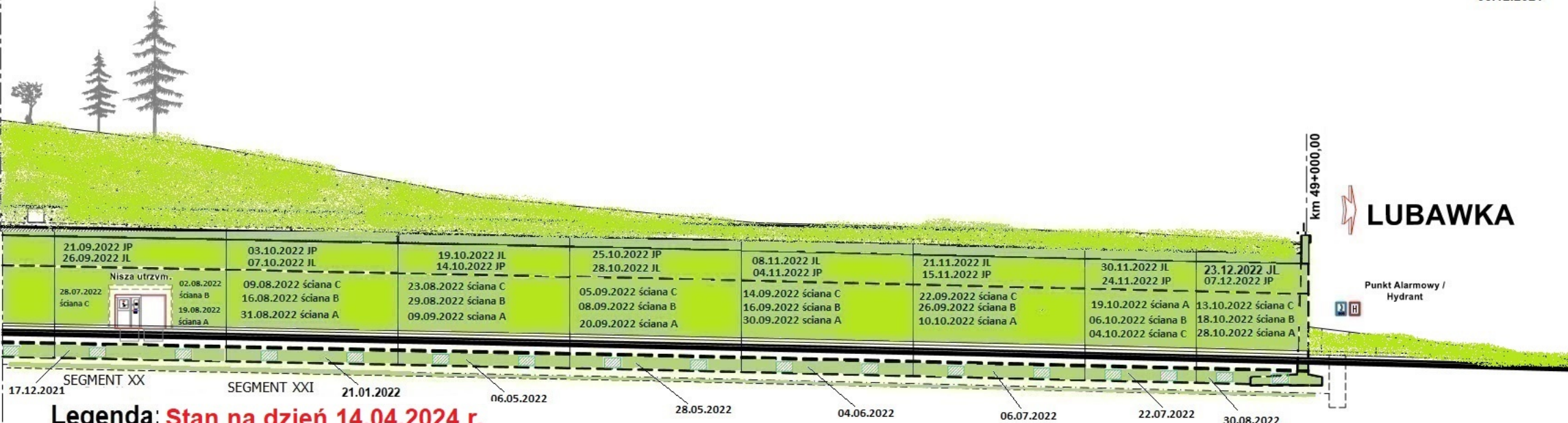
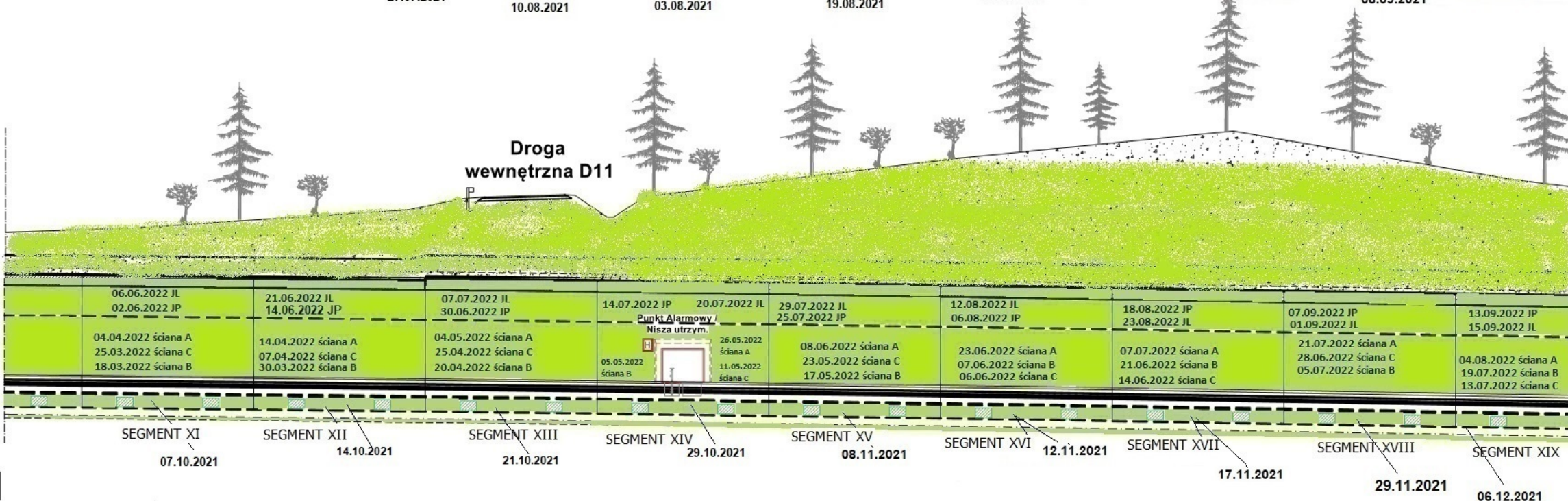
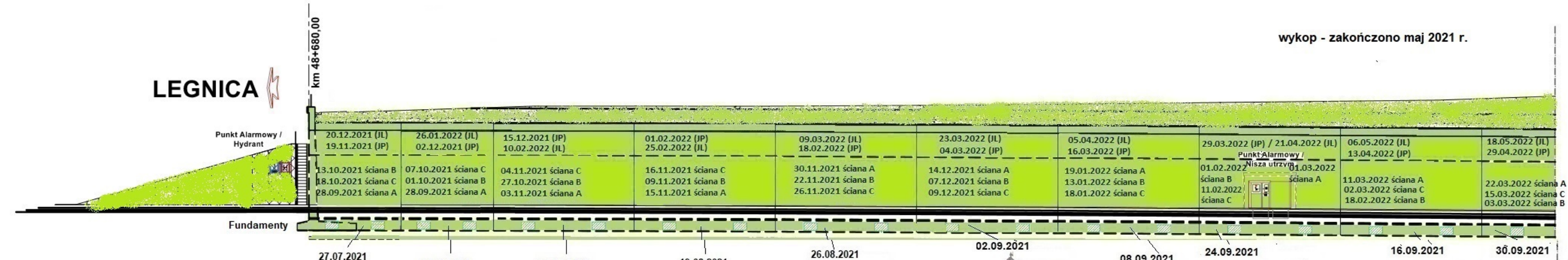

Legenda: Stan na dzień 14.04.2024 r.

- Roboty w trakcie wykonywania
- Roboty zakończone

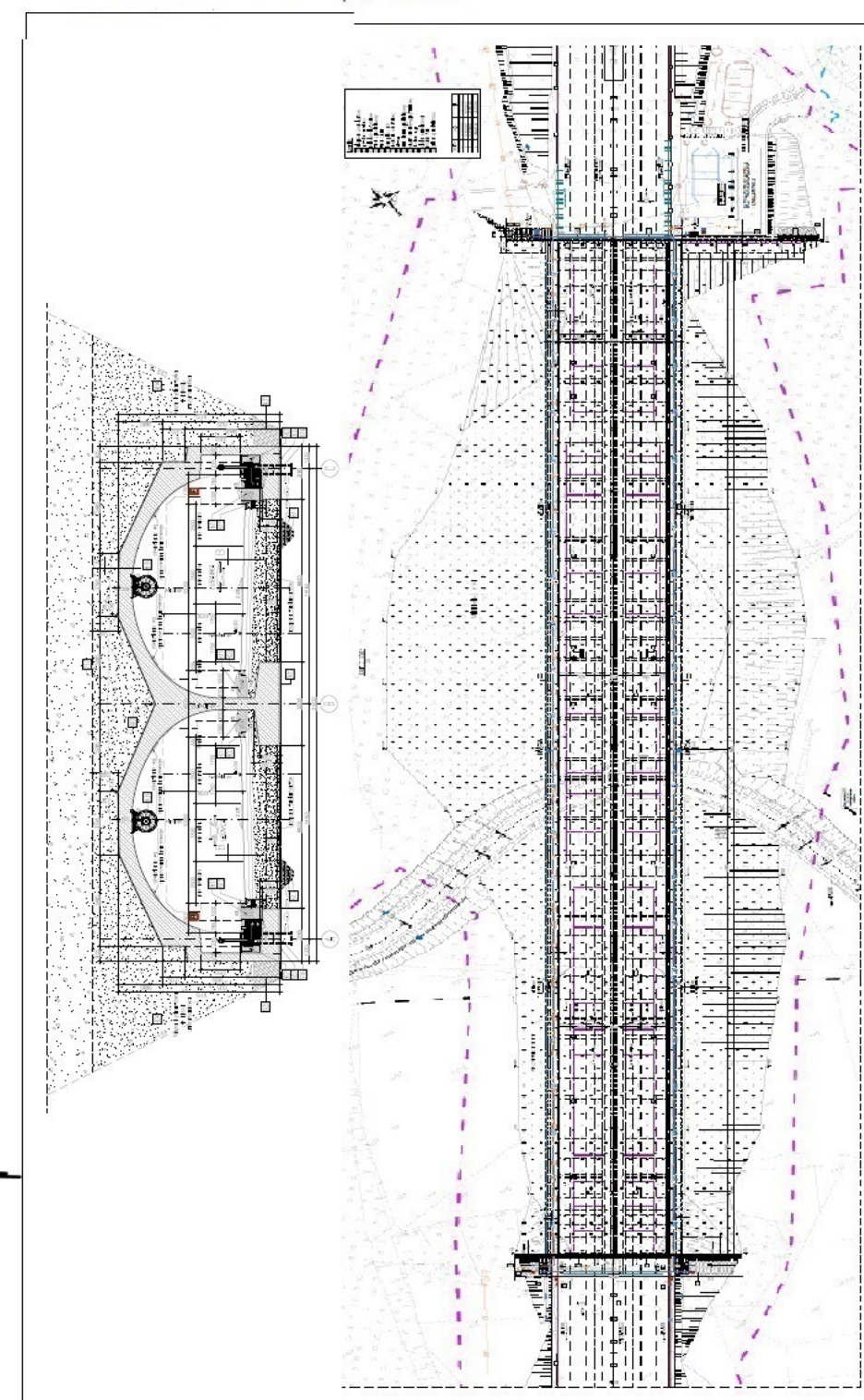

PG 10.1

km 50+097,00

← LEGNICA SMA → LUBAWKA →

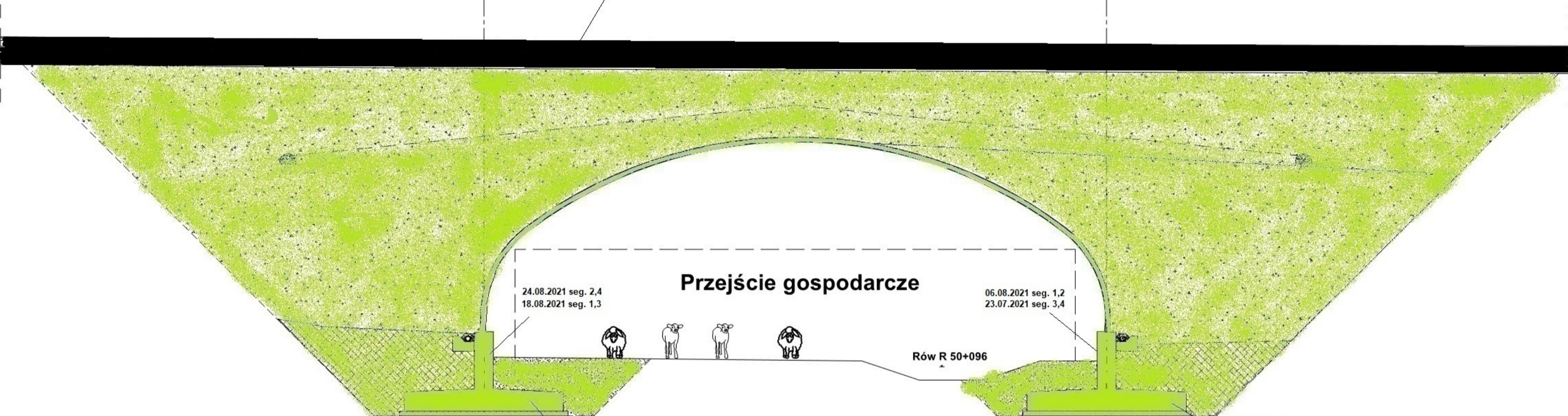

Legenda: Stan na dzień 14.04.2024 r.

- Roboty w trakcie wykonywania
- Roboty zakończone

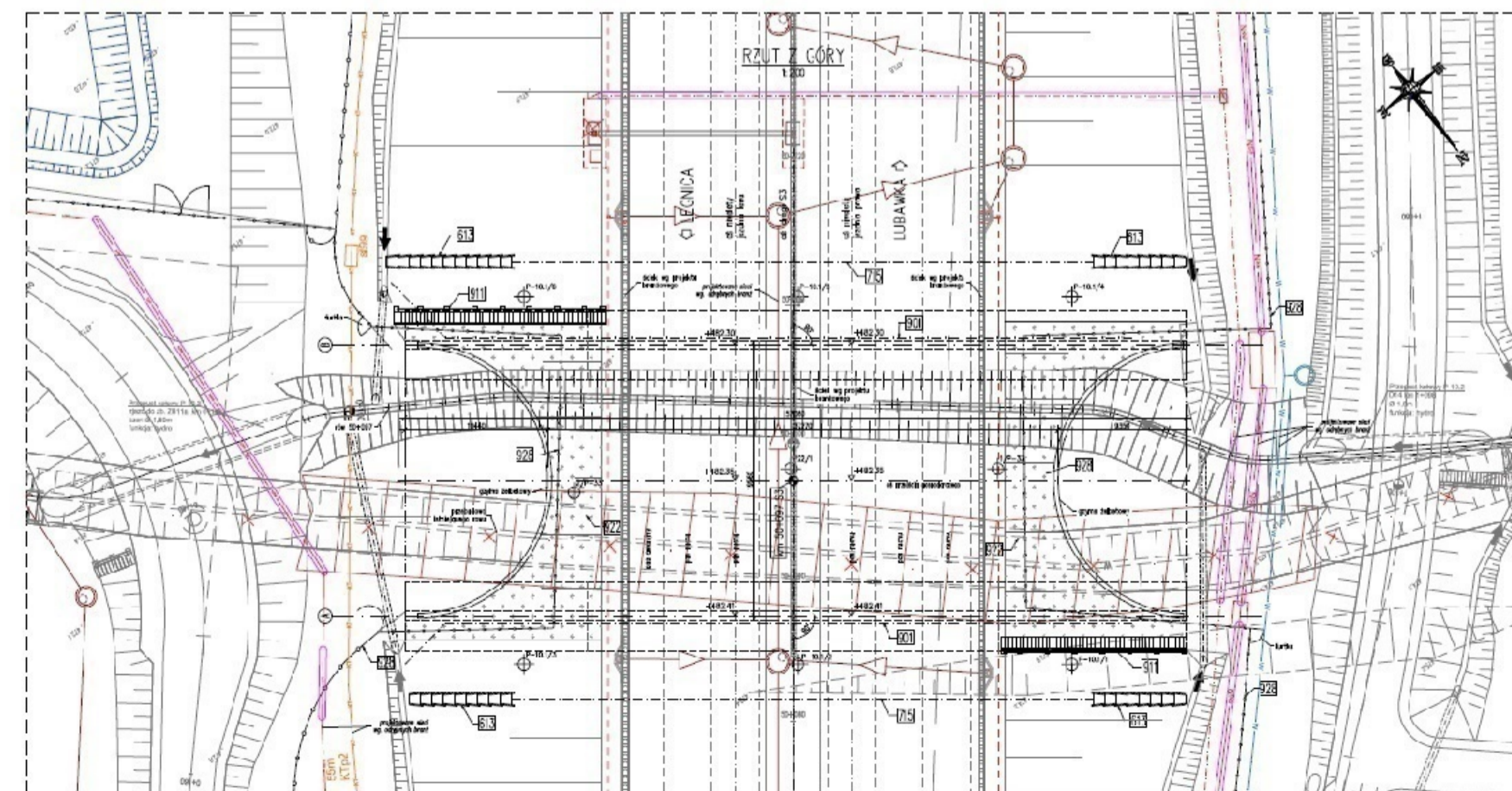
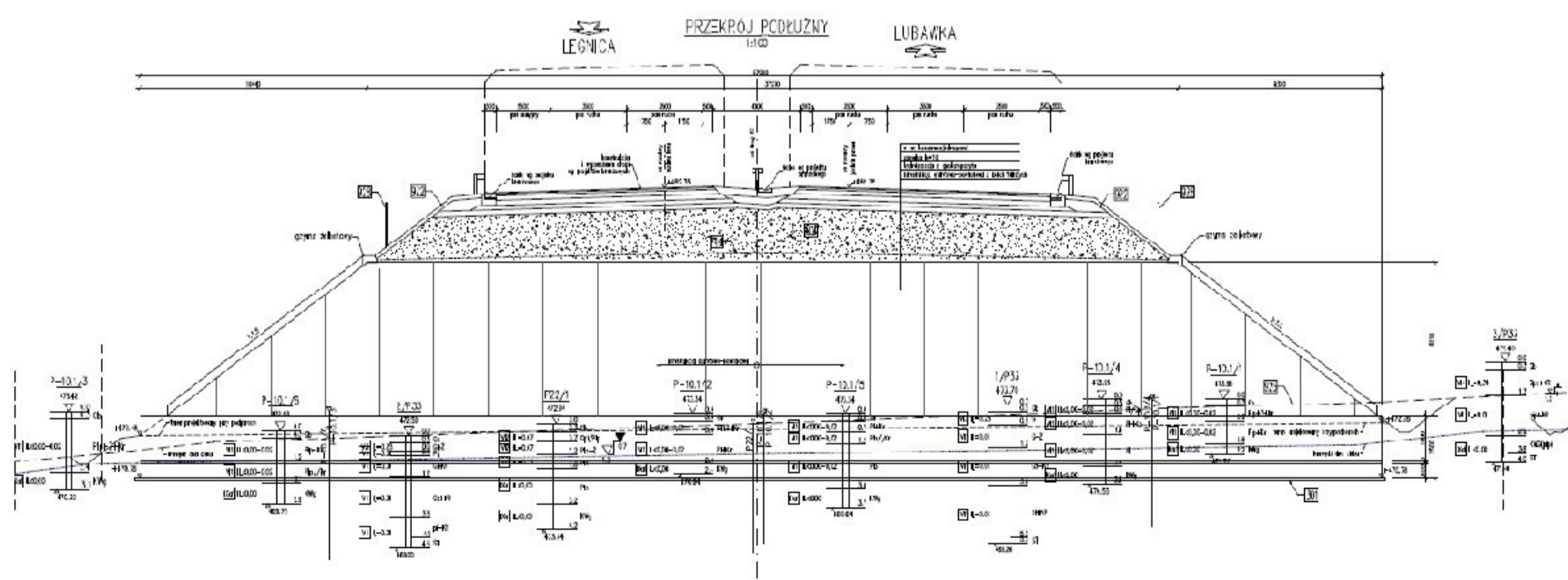

WS-33
km 49+530,70

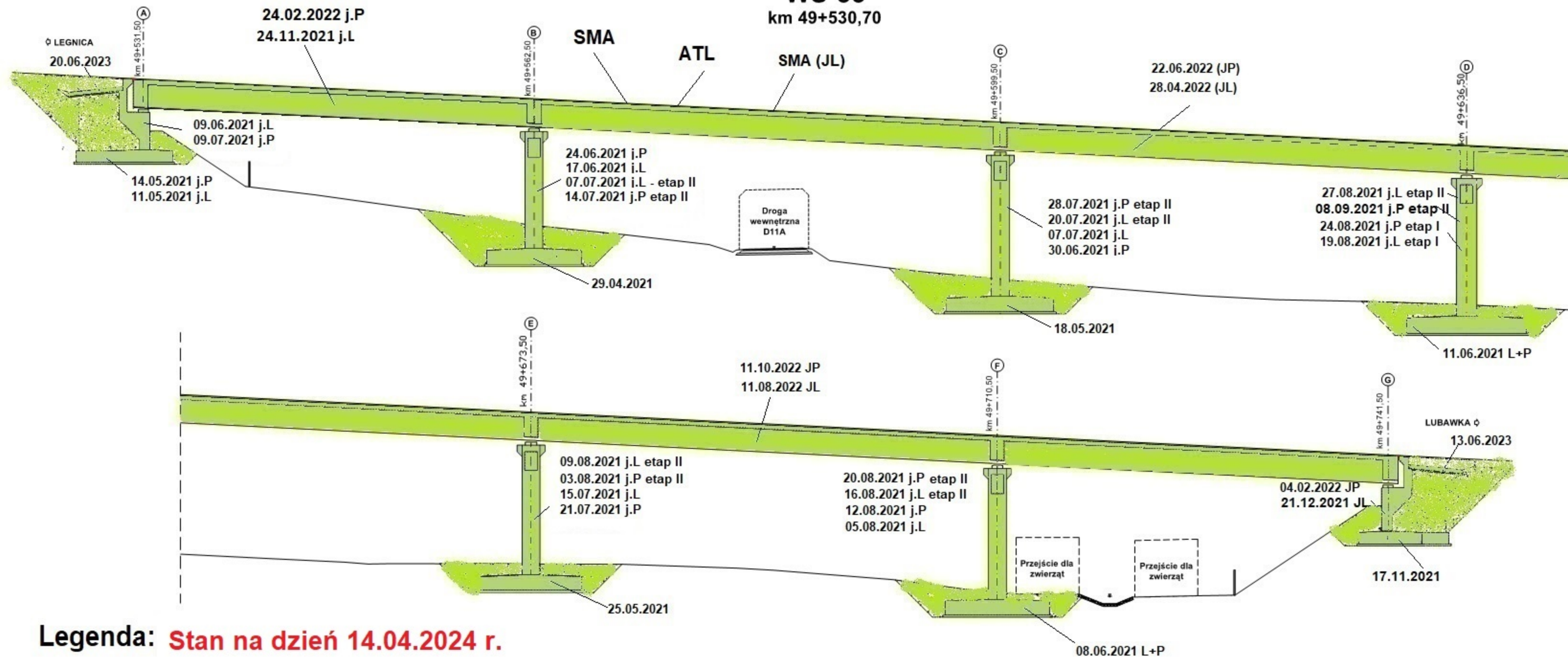

Legenda: Stan na dzień 14.04.2024 r.

- Roboty w trakcie wykonywania
- Roboty zakończone

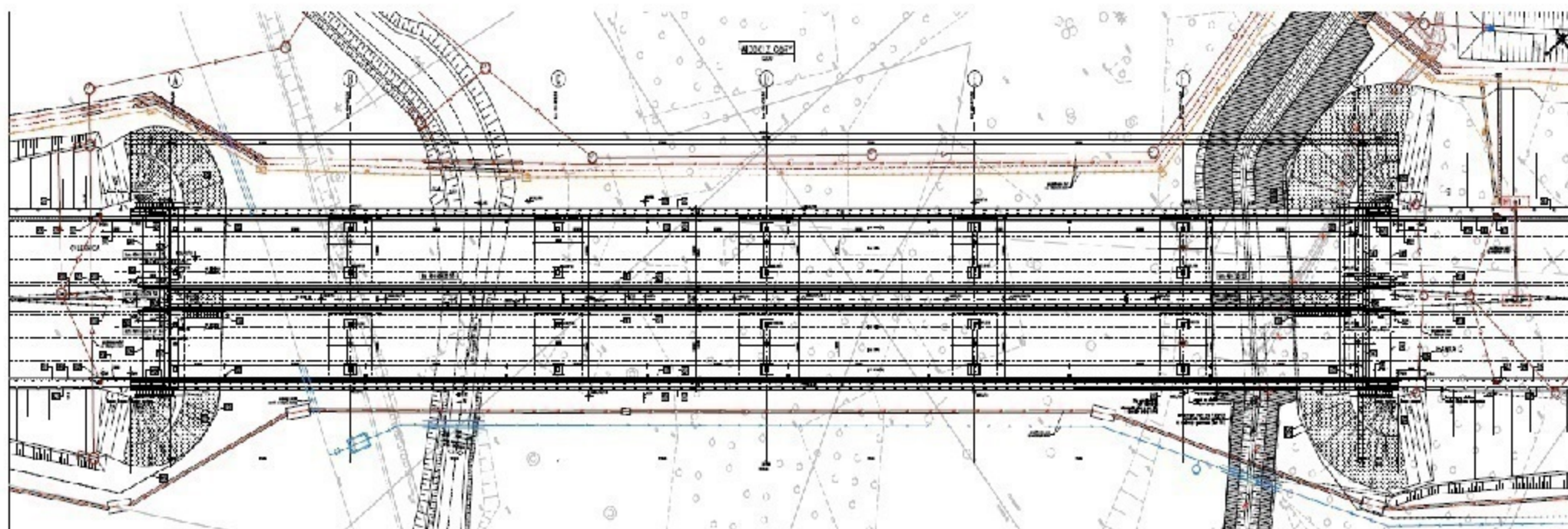
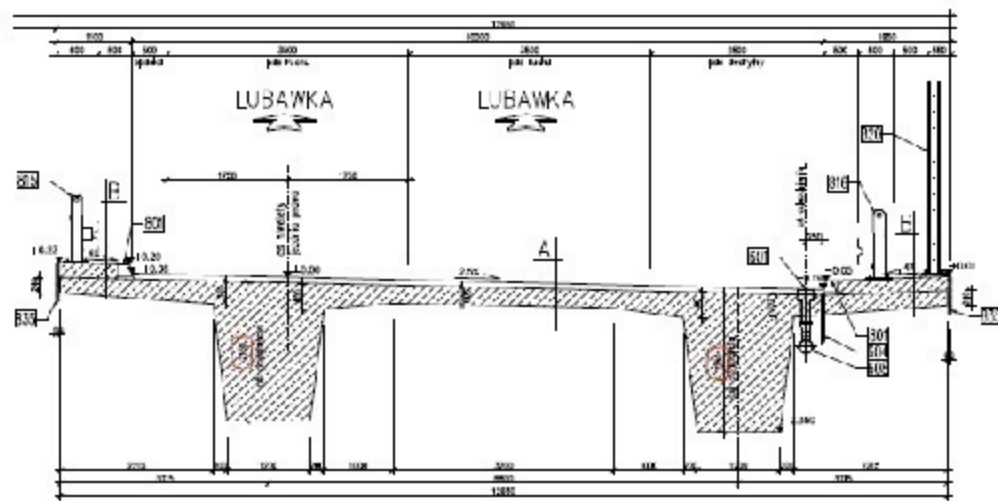

WD-34

km 50+661,15

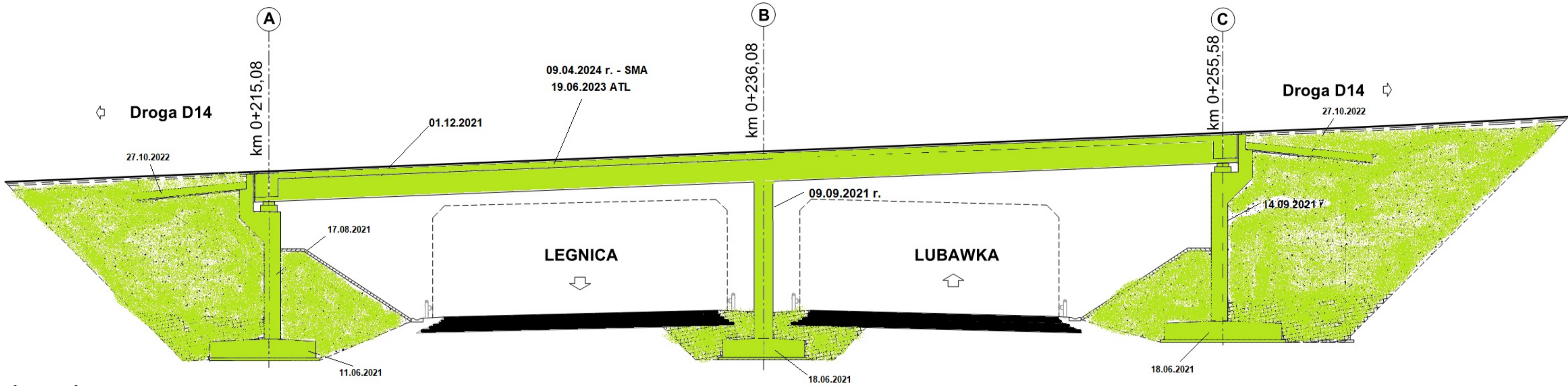

Legenda: Stan na dzień 14.04.2024 r.

- Roboty w trakcie wykonywania
- Roboty zakończone

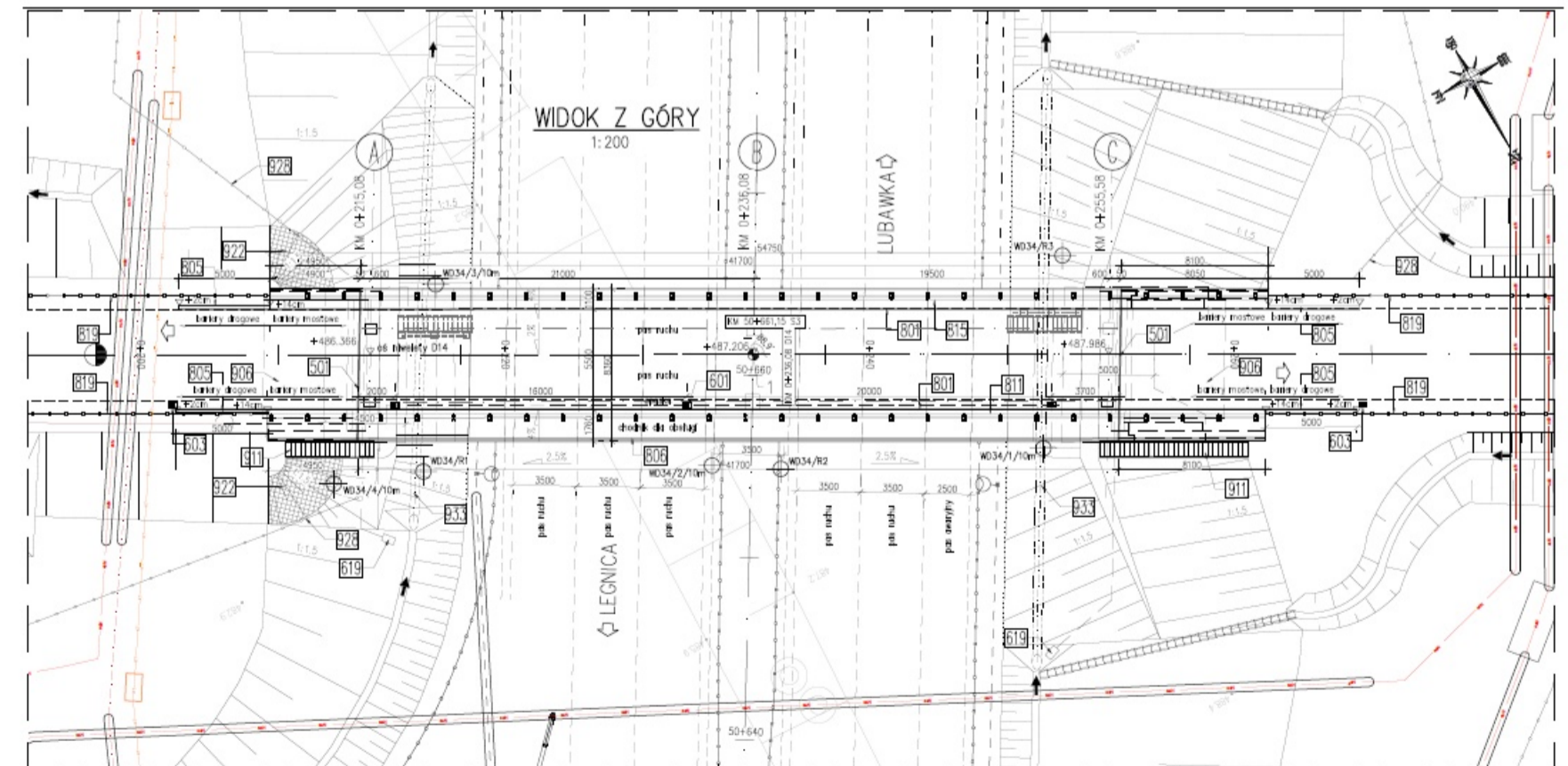

PG 11.1

km 51+249,00

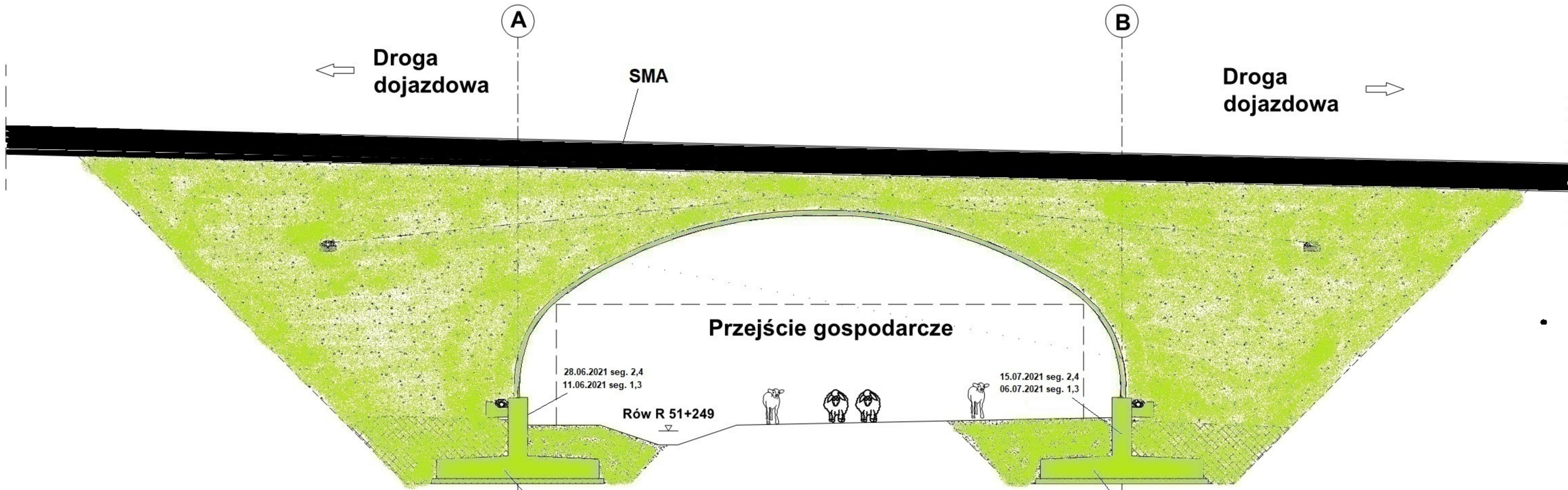

Legenda: Stan na dzień 14.04.2024 r.

- Roboty w trakcie wykonywania
- Roboty zakończone

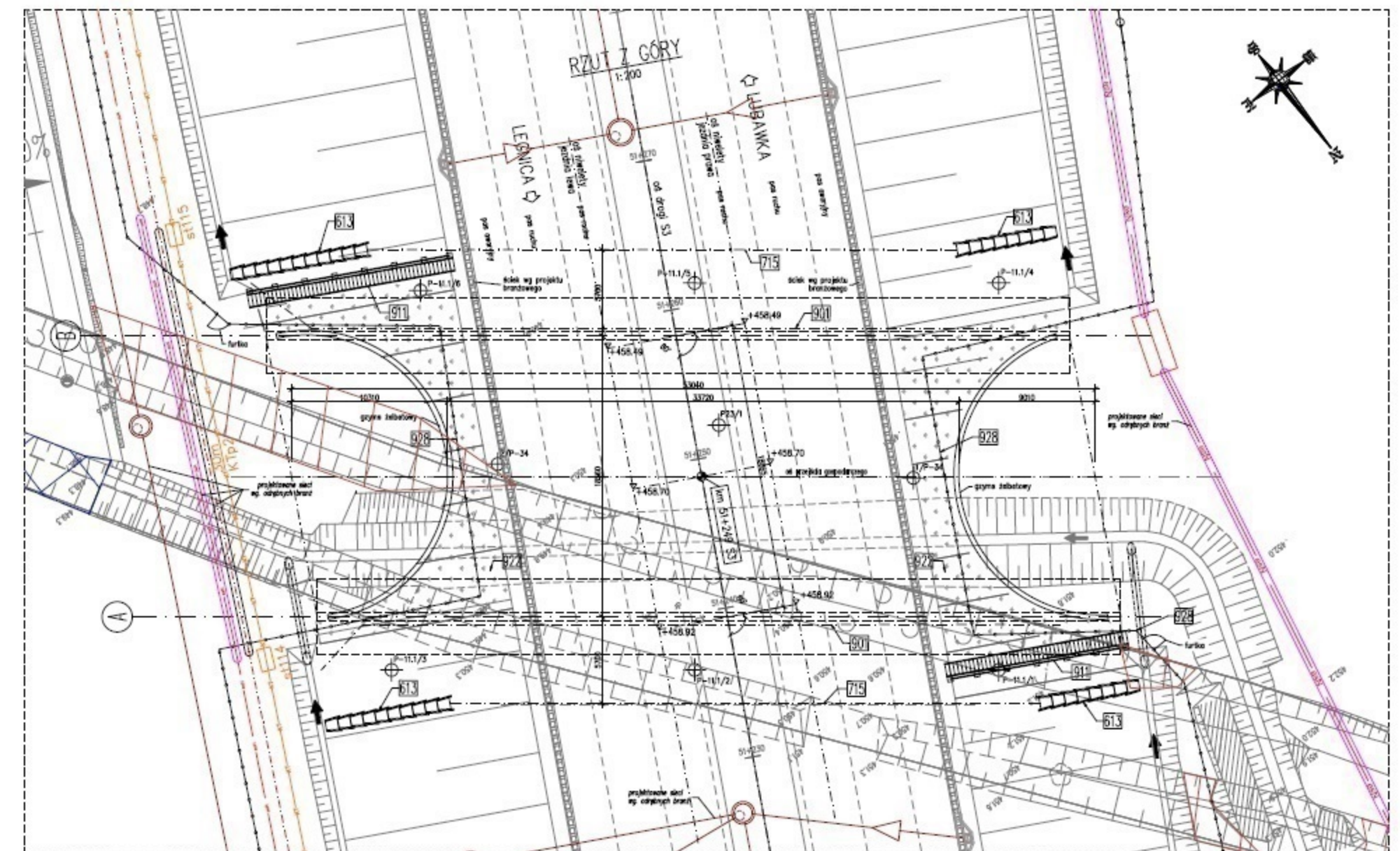
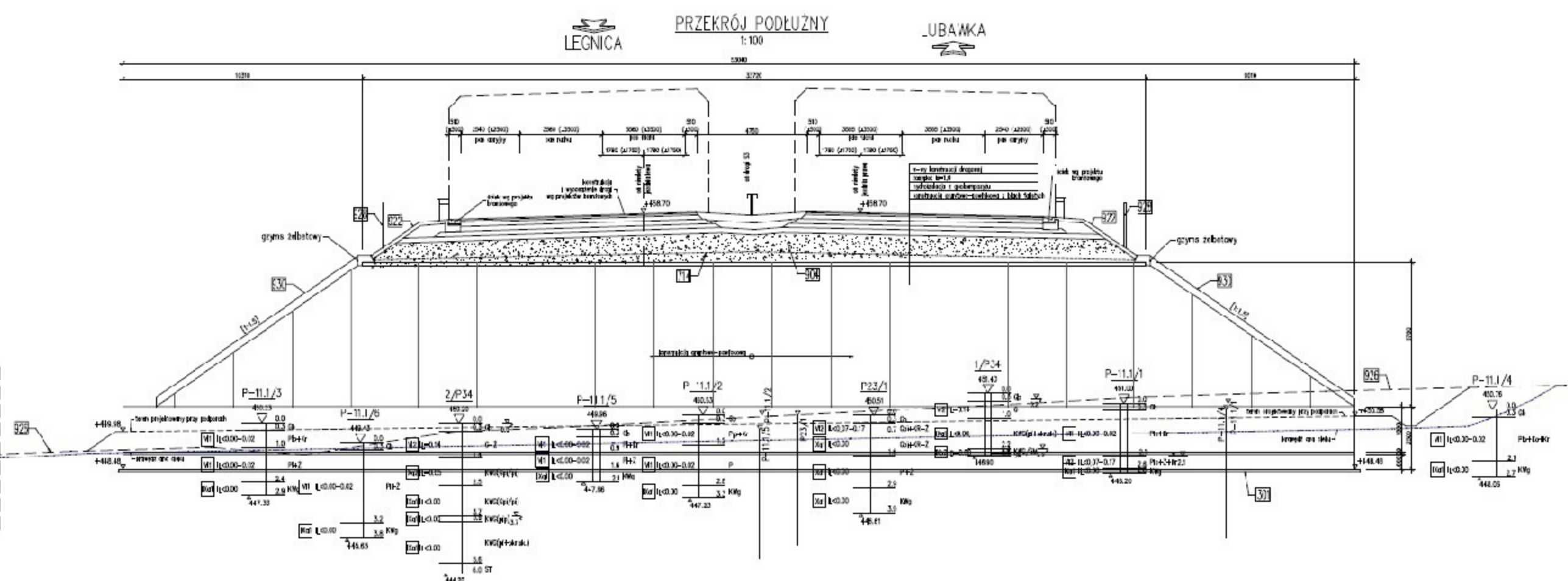

WS-35 km 51+508,81

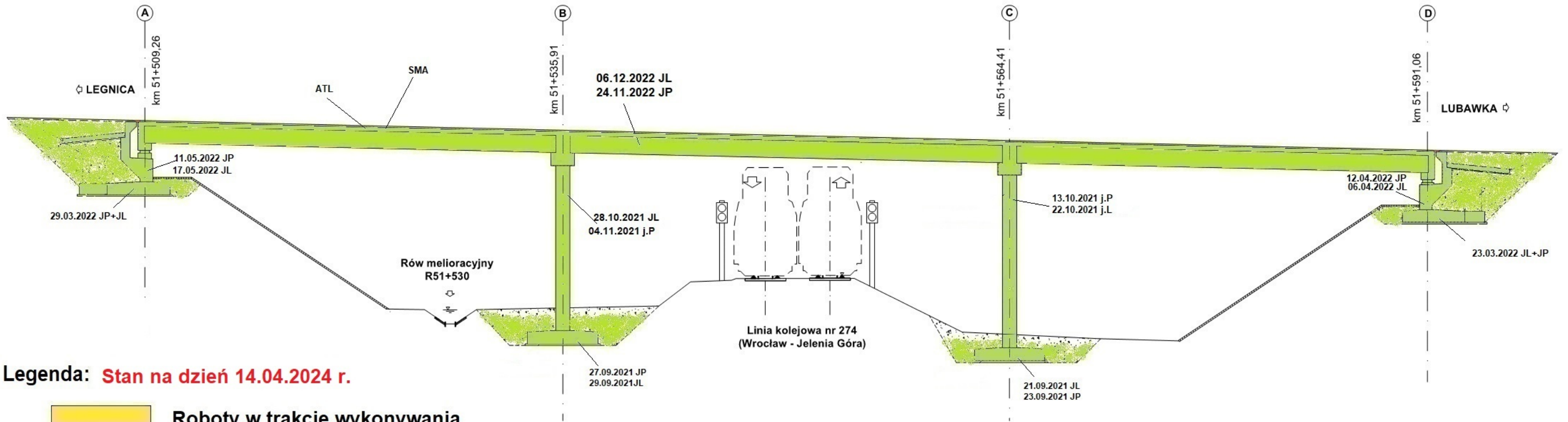

Legenda: Stan na dzień 14.04.2024 r.

- Roboty w trakcie wykonywania
- Roboty zakończone

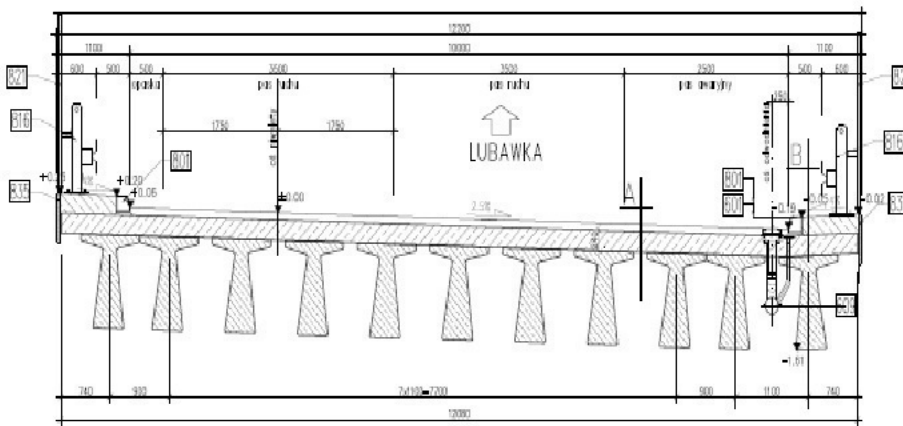

WS-36 km 51+780,95

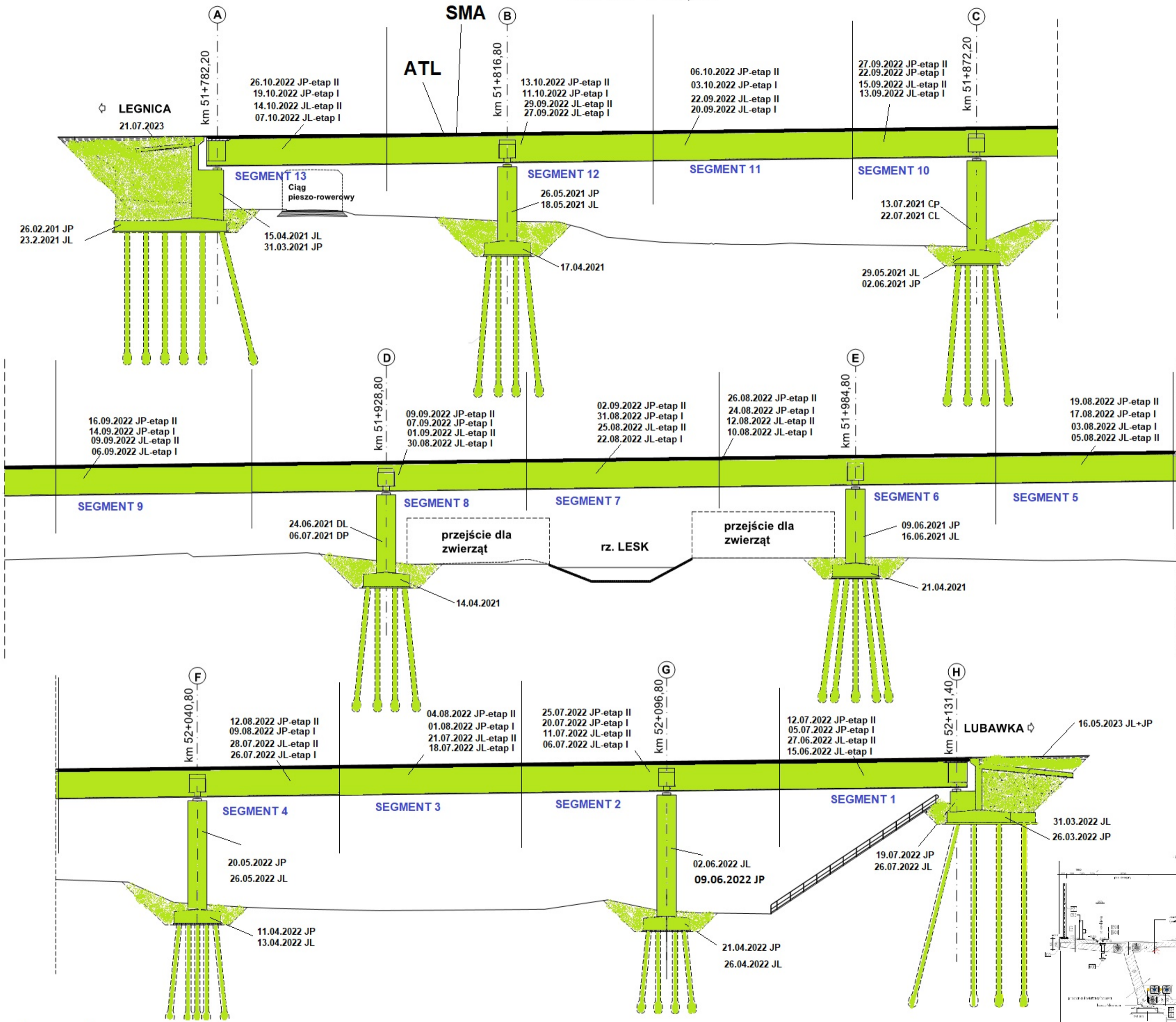

Legenda: Stan na dzień 14.04.2024 r.

- Roboty w trakcie wykonywania
- Roboty zakończone

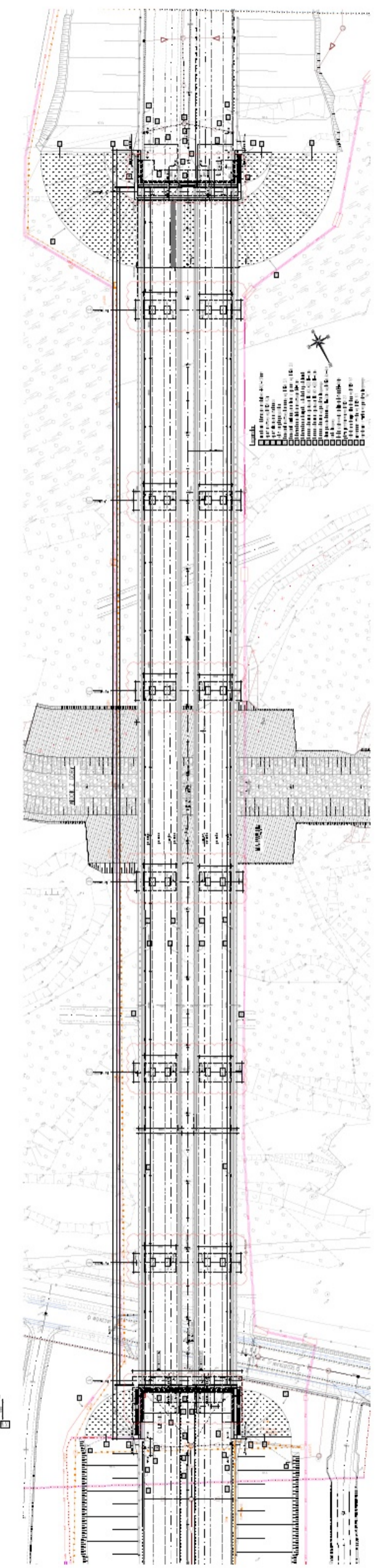
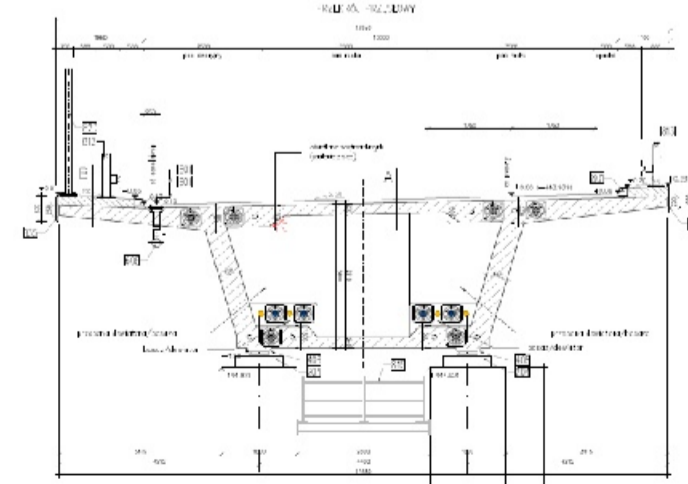

WS-37

km 52+994,25

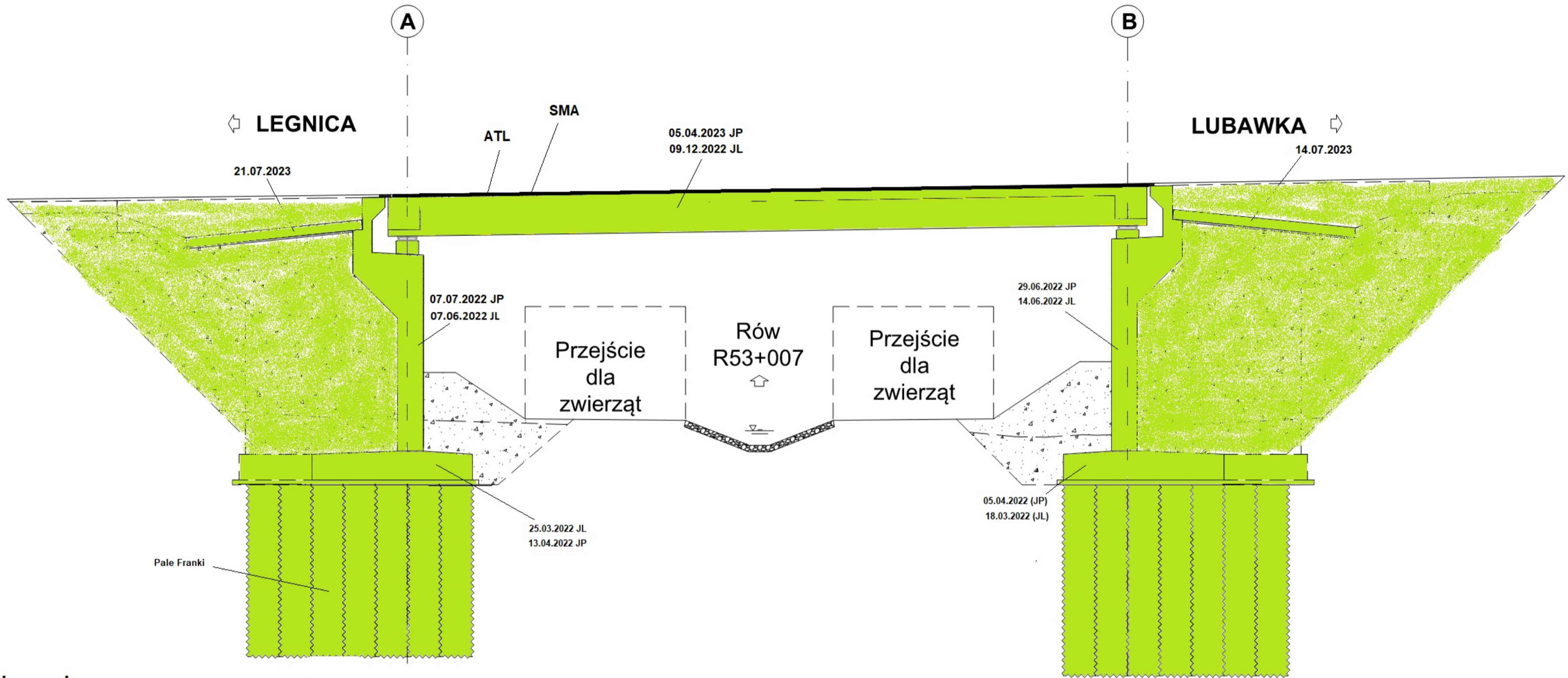

Legenda: Stan na dzień 14.04.2024 r.

- Roboty w trakcie wykonywania
- Roboty zakończone

PRZEKRÓJ POPRZECZNY
PRZEŚLONY, NORMALNY
1:50

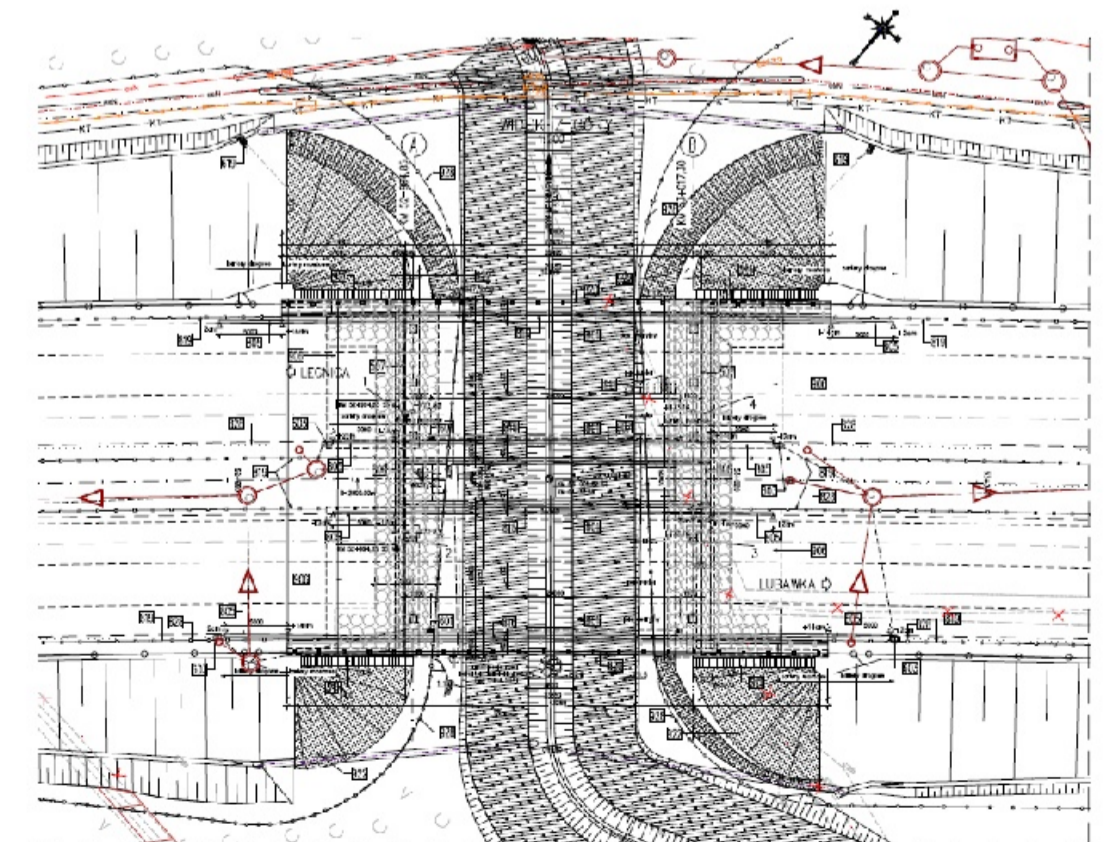
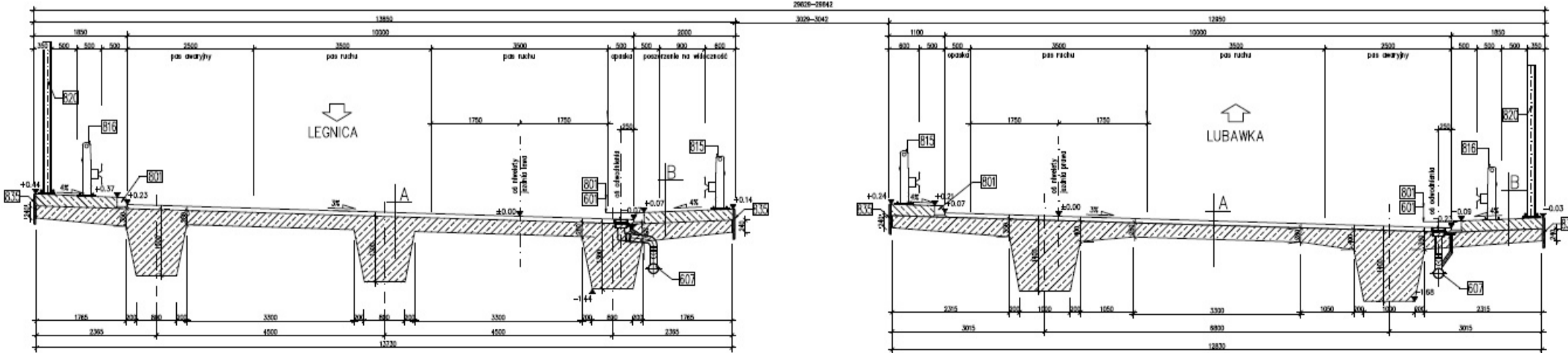

WD-38

km 53+798,79

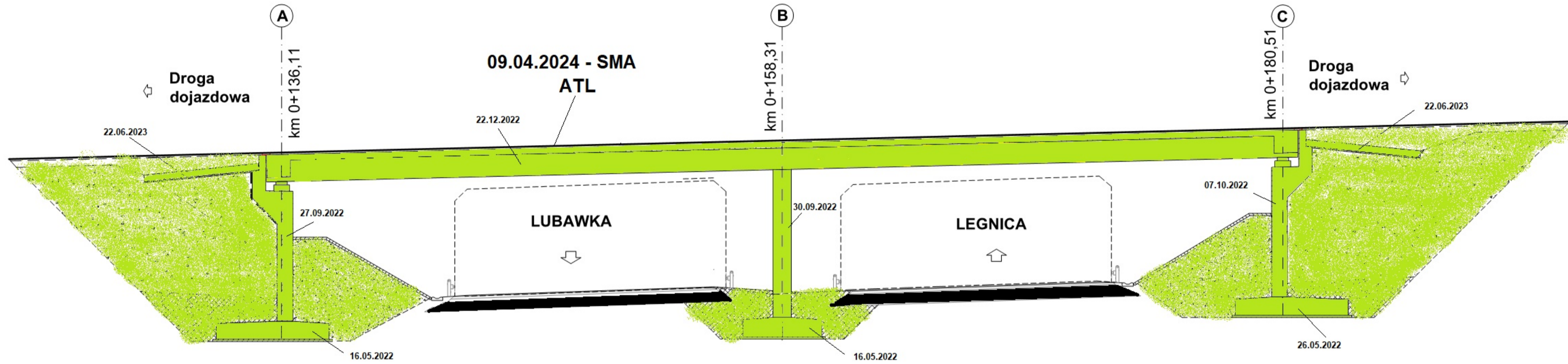

Legenda Stan na dzień 14.04.2024 r.

- Roboty w trakcie wykonywania
- Roboty zakończone

PRZEKRÓJ POPRZECZNY
PRZESŁONY NORMATYWNY
1:30

